

COMPANY

We have a role in national and global engine industry whom needs pistons, for 30 years since 1976. We have been producing pistons for domestic and international markets years since 1976. We play a major player role in engine industry with our 30 years of experience, expert team of engineers, developing company structure, up to date machinery, product variety, production capacity, after sales services. We made a radical change and assumed the principle of providing production and logistic facilities for engine industry in 2015.

We developed and renewed our technological infrastructure as the results of our R&D efforts to increase our capacity. With these progresses we increased our quality of our products and made them more long lasting. We reached 300.000 product capacity per year with our 300 sort of pistons with the robot technology we use.

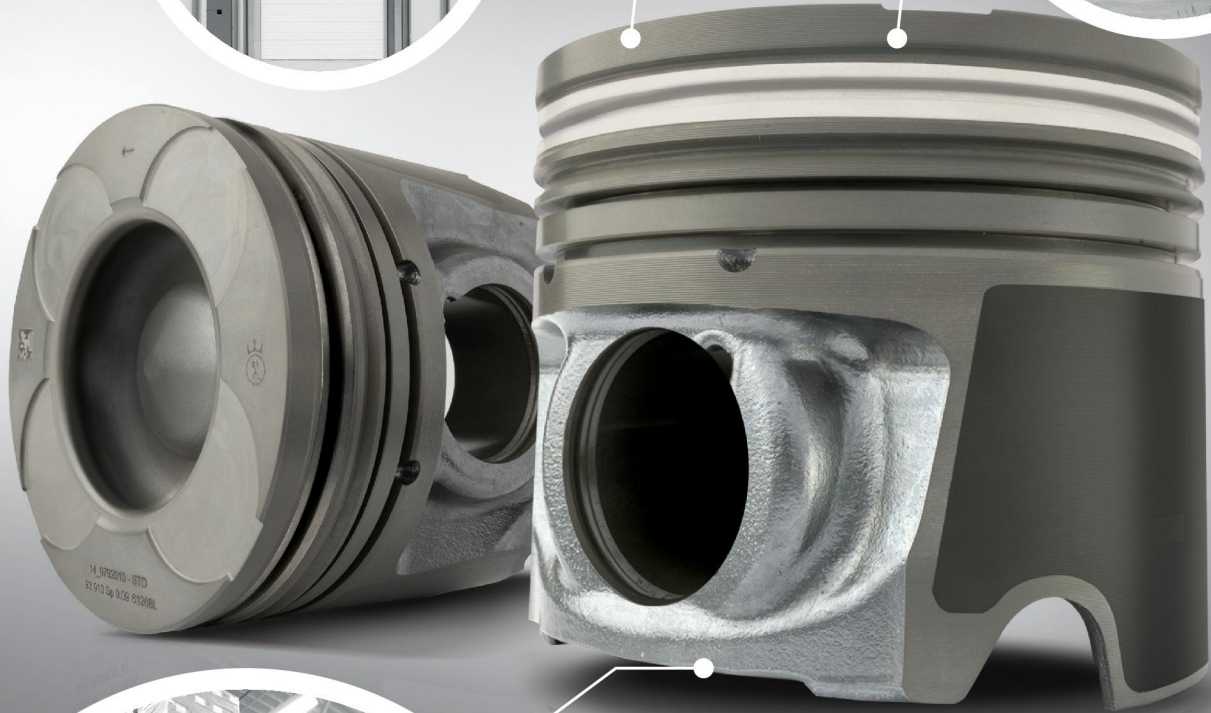

We had enlarged our inventory space to reduce the inventory costs and answers the demands when its needed fort he companies we serve. Without any limits we provide the demands not just by periods of years, we also serve the companies by periods of months and weeks.

As MYM we are proud to announce that we are established to provide superior service for the smallest business to the largest firms of national and global engine industry.

Our mission

To show a steady improvement to our well-established past, to increase our production capacity, to extend our distribution network, to extend the durability period of our products and to provide a unique service experience with the support we provide after sales.

Our vision

And that in Turkey as an example of competing firms in the world and was inspired, not only with quality products that we produce at the same time also be a company that makes a difference in the service we provide.

Our strategy

To provide modernization of piston production with our AR-GE work and give a new direction to the national and international motor sector with our after-production services.

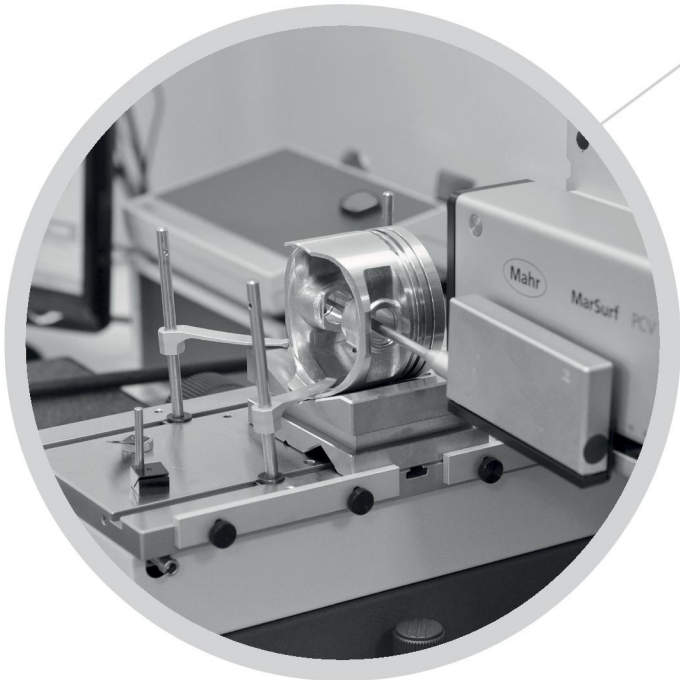

MANUFACTURING

We do our manufacturing activities with our 58 employees, in our factories with one of them are 5000 m² outdoor and 4000 m² indoor and the other one is 10000 m² outdoor and 7000 m² indoor at Cerkezoy, Tekirdag. We present our products to the market by controlling the quality with our post production devices, and using the latest technology.

RECOMMENDATIONS FOR THE INSTALLATION OF RING AND PISTON

We serve the pistons with pre-assembled piston rings to our customers.
Even so we recommend to check following points:

- Please check if the piston rings fit in their grooves.
- The ring grooves must be clean.
- The top marking on the rings must be upwards to piston crown.
- In case the piston rings have been disassembled, please assemble the rings starting from the lowest ring upwards using appropriate tool. Do not open the rings more than necessary and do not strain the rings more than 1 minute, since it could cause deformation of the ring.
- For oil rings with spring; spring ends must be positioned 180° from ring gap.
- For oil rings 3 pieces type; spring should be assembled first. After the spring has been installed the rails must be mounted holding the spring. The spring ends must be held together to avoid overlapping.
- After assembling the rings, ring gaps are to be positioned with same angle to each other around the piston (Example: On a piston with 3 rings, ring gaps must be positioned 120° to each other).

For a correct installation of the piston into engine, please read following points carefully:

- Some features on a piston like chamber, valve reliefs, pin hole etc. can be asymmetric or eccentric from piston center. For a proper functionality, direction mark on top of the piston must be considered.
- Do not machine any coated and anodized surface.
- Do not measure any dimension on graphite coated surfaces. Uncoated areas are recommended for measurements.
- Diameter value + Sp-Value must be equal to liner diameter. If it is not the case, installation must be cancelled.
- Appropriate tools must be used for installing pistons into engine.
- Removed old parts must be disposed accordingly.



INFORMATION MARKS ON PISTON





PISTON DIMENSIONS

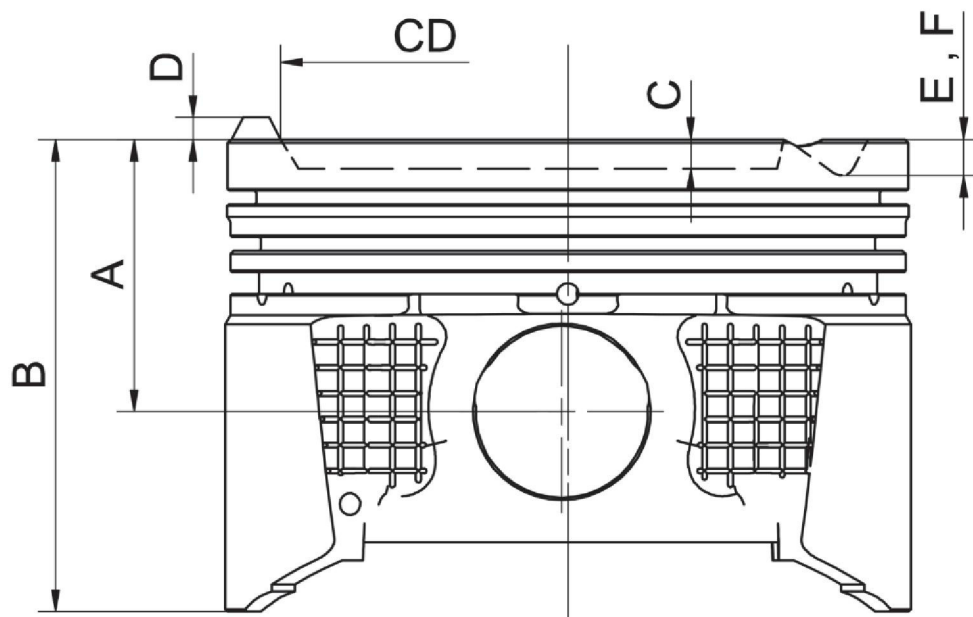

- A - Compression Height
- B - Total Length
- C - Chamber Depth
- D - Dome Height
- CD - Chamber Diameter
- E,F - Valve Cutouts Depth

Piston Specifications

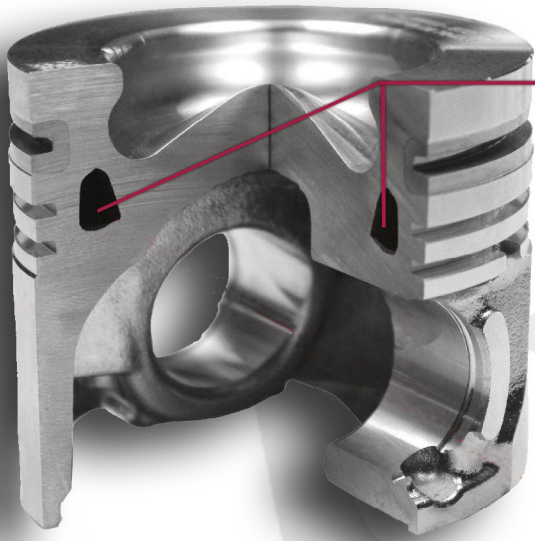

Oil Gallery

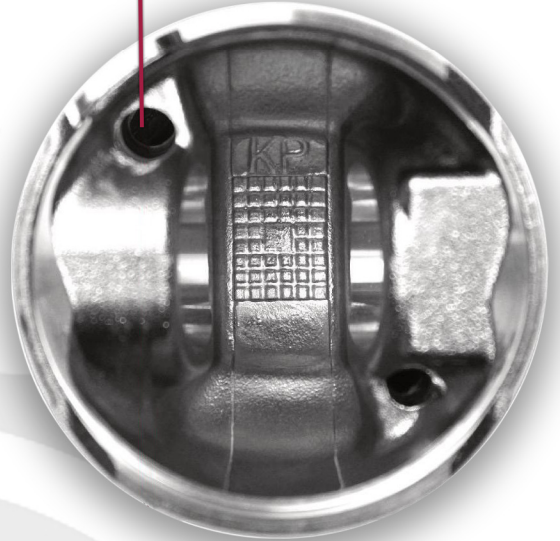

Hard Anodising



Bushing

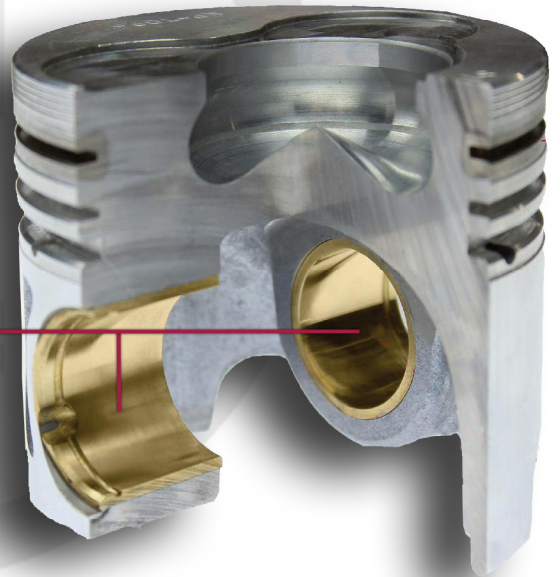

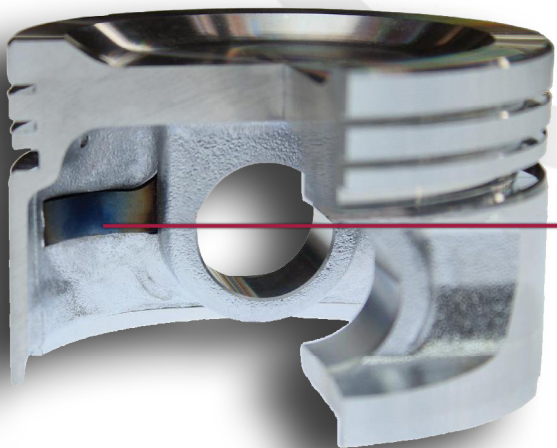

Steel Plate

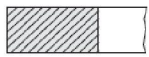
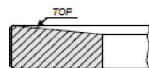
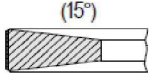
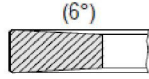
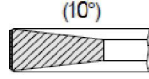

1) Cross-section configurations

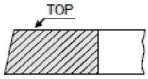
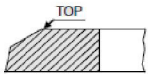
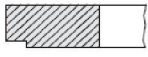
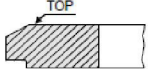
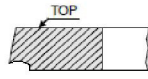
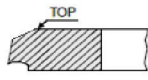
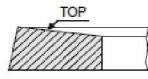
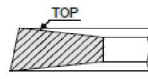
Top Rings		
500	Rectangular ring	
503	Half Keystone ring	
504	Keystone Ring (15°)	
505	Keystone Ring (6°)	
514	Keystone Ring (10°)	

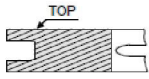
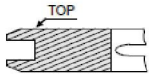
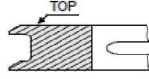
Compression Rings		
501	Taper-faced ring	
502	Taper-faced bevelled ring	
506	Scraper ring	
507	Scraper bevelled ring	
508	Taper-faced Napier ring	
509	Taper-faced Napier bevelled ring	
510	Taper-faced, Half Keystone ring	
511	Taper-faced, Keystone ring	

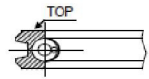
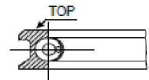
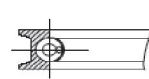
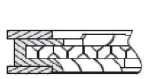
Oil Rings		
600	Slotted Oil control ring	
601	Bevelled-edge Oil control ring	
602	Double-bevelled Oil control ring	
603	Coil Spring loaded Oil control ring	
604	Coil Spring loaded Bevelled-edge Oil control ring	
605	Coil Spring loaded Double-bevelled Oil control ring	
606	Coil Spring loaded Internal Bevelled-edge Oil control ring	
700	RIK-VENT, Expander Oil control ring	



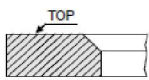
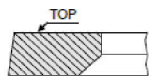
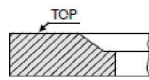
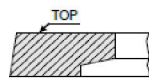
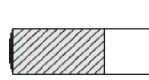
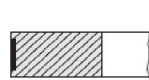





2) Edge and Face configurations



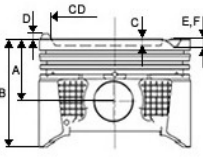





IF	Internal bevel top	
IFU	Internal bevel bottom	
IW	Internal step top	
IWU	Internal step bottom	
B	Barrel faced	
N	Coated Inlaid faced	

3) Coating and Material configurations

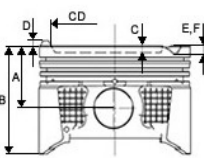
Cr	Surface chromium plating
Cr3	Side chromium plating
Cr4	Full chromium plating
Mo	Surface molybdenum plating
Nit	Nitriding
PI	Plasma spray coating

QBCr	"Quick Break-In" chromium plating
IP	Ion Plating
Fe	Ferrox treatment
P	Phosphate treatment
S	Steel material

							
Engine	Ref. No. - Kit 1	Dimensions	Rings	Pin	Piston Liner	Kit 2	Info
<p>ø83,00</p> <p>4 Cyl. Gasoline AR 32310</p> <p>156 (932): 2.0 16V T.SPARK (932A21__)</p>	<p>18-9510010 STD -mm 18-9510012 0,40 mm</p>	<p>A = 31,300 B = 51,300 C = 3,800 CD= 69,000</p> <p>Steel Support</p>	<p>RE11250000 -STD RE11250040 -0,40</p> <p>1,200 (500) Nit S IF 1,200 (508) P 2,000 (700) Nit S</p>	<p>ø21,0 x 57,0</p>			

							
Engine	Ref. No. - Kit 1	Dimensions	Rings	Pin	Piston Liner	Kit 2	Info
<p>ø69,50</p> <p>4 sil.benzin 1100 cc FA FJ GG HB <u>04/74 - 07/83</u></p> <p><i>Golf Polo Jetta Audi 50</i></p>	<p>18-1910010 STD -mm 18-1910013 0,50 mm</p>	<p>A = 40,200</p>	<p>RE53050000 -STD RE53050050 -0,50</p> <p>1,500 (500) Cr S 1,500 (501) P 3,000 (700) Cr S P</p>	<p>ø100,0 x 0,0</p>			
<p>ø69,50</p> <p>R 4 Petrol, 895 cm³ 29,5 kW (40 hp), 8:1 FA FJ GG HB <u>1974 -....</u></p> <p><i>Golf Polo Jetta Audi 50</i></p>	 <p>18-7010010 STD -mm 18-7010013 0,50 mm</p>	<p>A = 40,200 B = 67,000 C = 4,000</p>	<p>RE53050000 -STD RE53050050 -0,50</p> <p>1,500 (500) Cr S 1,500 (501) P 3,000 (700) Cr S P</p>	<p>ø20,0 x 54,0</p>			

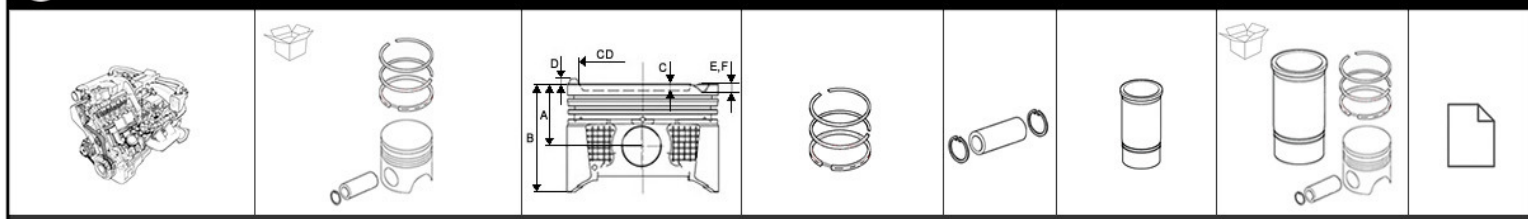









Engine Ref. No. - Kit 1 Dimensions Rings Pin Piston Liner Kit 2 Info

ø75,00	14-7010360 STD -mm	A = 47,370 B = 73,500 C = 6,800 CD= 1,000	RE56070000 -STD 1,500 (500) CrB Fe S IF 1,500 (501) P 2,500 (700) Cr P S	ø20,0 x 50,0			
4 Cyl. Gasoline 1043 cc 33 Kw (45 Ps) 9.8: AAU <u>1990 - 1994</u> Golf Polo Vento (1990-1994)		Steel Support					

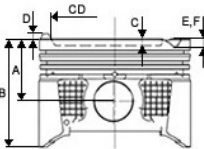

ø76,50	18-7010280 STD -mm 18-7010280-30 STD -mm 18-7010283 0,50 mm 18-7010283-30 0,50 mm	A = 29,000 B = 48,200 C = 5,900 D = 1,850 E = -1,100 F = -3,900	RE56200000 -STD RE56200050 -0,50 1,200 (500) NitBS 1,500 (501) P 2,000 (700) NitS	ø19,0 x 54,0			
4 Cyl. Gasoline 1390cc 103 Kw (140/170 Hp) BMY BLG CAVD <u>2006 -....</u> GOLF 1.4 TSI JETTA 1.4 TSI Jetta 1.4TSI16V Touran 1.4FSI16V Touran 1.4 TSI16V Golf Plus 1.4TSI16V Golf V 1.4FSI+TSI16V Tiguan 1.4TSI16V Scirocco 1.4TSI16V Beetle 1.4TSI		Hard Anodising					

Engine	Ref. No. - Kit 1	Dimensions	Rings	Pin	Piston Liner	Kit 2	Info
<p>ø76,50</p> <p>4 Cyl. Gasoline 1390 cc 40 44 Kw (54 60 Ps) AEX <u>1995 - 1997</u></p> <p><i>Golf Polo Vento/1389 cc</i></p>	<p>18-7010530 STD -mm 18-7010533 0,50 mm</p>	<p>A = 28,350 B = 50,350 C = 5,900</p>	<p>RE56310000 -STD RE56310050 -0,50</p> <p>1,200 (500) NitB S IF 1,500 (508) P 2,500 (700) Cr P S</p>	<p>ø17,0 x 52,0</p>			
<p>ø76,50</p> <p>4 Cyl. Gasoline 1390 cc 74 Kw (100 Ps) AFH AFK AHW AKQ ANM AQQ AUB AUA AXP <u>1996 -....</u></p> <p><i>Audi A2 1.4 Fabia Octavia</i></p>	<p>18-7010620 STD -mm 18-7010623 0,50 mm</p>	<p>A = 28,920 B = 49,920 C = 1,980 E = -2,323 CD= 61,900</p>	<p>RE56310000 -STD RE56310050 -0,50</p> <p>1,200 (500) NitB S IF 1,500 (508) P 2,500 (700) Cr P S</p>	<p>ø17,0 x 52,0</p>			

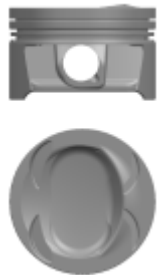
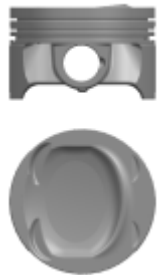

							
Engine	Ref. No. - Kit 1	Dimensions	Rings	Pin	Piston Liner	Kit 2	Info
<p>ø76,50</p> <p>4 Cyl. Gasoline 1390cc 90 92 KW(122 125 BG) CAX CAXA CMSA <u>2007 -....</u></p> <p>VW EOS 1.4FSI16V VW Golf Plus 1.4FSI16V Golf V 1.4FSI16V Golf V 1.4TFSI16V Golf V 1.4TFSI16V Jetta 1.4FSI16V Passat 1.4FSI16V Scirocco 1.4TFSI16V</p>	<p>18-7010630 STD -mm 18-7010633 0,50 mm</p>	<p>A = 29,200 B = 48,200 C = 4,500 E = -3,600 F = -0,700</p> <p>Hard Anodising</p>	<p>RE56450000 -STD RE56450050 -0,50</p> <p>1,200 (500) NitB S 1,200 (501) P 2,000 (700) Nit S</p>	<p>ø19,0 x 52,0</p>			
<p>ø76,50</p> <p>4 Cyl. Gasoline 1390cc 103 KW (170 Ps) BMY BLG CAVD <u>2006 -....</u></p> <p>Jetta 1.4TFSI16V Touran 1.4FSI16V Touran 1.4 TFSI16V Golf Plus 1.4TFSI16V Golf V 1.4FSI+TFSI16V Tiguan 1.4TFSI16V Scirocco 1.4TFSI16V Beetle 1.4TFSI</p>	<p>18-7010640 STD -mm 18-7010643 0,50 mm</p>	<p>A = 29,000 B = 48,200 C = 5,900 D = 1,850 E = -1,100 F = -3,900</p> <p>Hard Anodising</p>	<p>RE56200000 -STD RE56200050 -0,50</p> <p>1,200 (500) NitBS 1,500 (501) P 2,000 (700) NitS</p>	<p>ø19,0 x 52,0</p>			

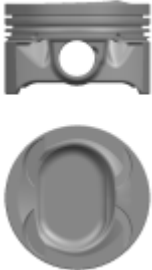









Engine	Ref. No. - Kit 1	Dimensions	Rings	Pin	Piston Liner	Kit 2	Info
<p>ø76,50</p> <p>4 Cyl. Gasoline 1390cc 118/136/110/132W 160ps CTJA/CTHG/CAVG CAVE/CTHA/CAVA CTHE/CTKA/CTHD CNWA/CAVD/CNWA CAVC/CAVB/CTHC CTHB</p> <p><u>2008 - 2014</u></p> <p>Touran/Golf/Plus Jetta/Tiguan Eos/Passat Scirocco/A1 Ibiza/Alhambra Fabia RS Sharan Passat CC Polo GTI (1.4 TSI/16V)</p>	<p>18-7010650 STD -mm 18-7010653 0,50 mm</p> 	<p>A = 28,970 B = 49,970 C = 4,570 D = 2,000 E = -4,000 F = -1,300</p> <p>Ring Carrier</p>	<p>RE56200000 -STD RE56200050 -0,50</p> <p>1,200 (500) NitBS 1,500 (501) P 2,000 (700) Nits</p>	<p>ø19,0 x 54,0</p>			
<p>ø76,50</p> <p>4 Cyl. Diesel 1588 cc 2383 cc 37/40/44/51 /55/57/60,5 Kw (50/54/60/69/75/78/82 Ps) D24 ADK CR JK JP CY JR JX MF ATC 1S CP DW 751</p> <p><u>1980 - 1992</u></p> <p>Volvo 240D/244D/245D/740D Golf Polo Bora Audi 80 1.6D/TD Audi 90 1.6TD Audi 100 2.0D/TD Audi 100 2.4TD SKODA</p>	<p>18-7050760 STD -mm 18-7050763 0,50 mm</p> 	<p>A = 41,700 B = 71,700 C = 1,600</p> <p>Ring Carrier Steel Support</p>	<p>RE56110000 -STD RE56110050 -0,50 RE56110100 -1,00</p> <p>1,750 (500) CrB Fe S 2,000 (501) Cr IFU 3,000 (604) Cr</p>	<p>ø24,0 x 64,0</p>			<p>1. Notch 1.40 mm Gasket + 0,67 + 0,80</p> <p>2. Notch 1.50 mm Gasket + 0,81 + 0,90</p> <p>3. Notch 1.60 mm Gasket + 0,91 + 1,02</p>

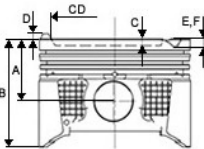





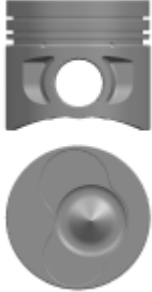
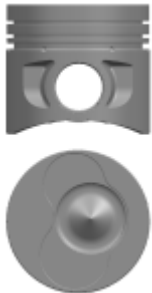

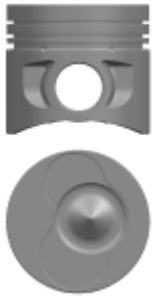
Engine	Ref. No. - Kit 1	Dimensions	Rings	Pin	Piston Liner	Kit 2	Info
<p>ø76,50</p> <p>4 Cyl. Gasoline 1390 cc 74 Kw (100 Ps) AFH AFK AHW AKQ ANM AQQ AUB AUA AXP</p> <p><u>1996 -....</u></p> <p>Audi A2 1.4 Fabia Octavia</p> 	<p>18-7010620 STD -mm 18-7010623 0,50 mm</p>	<p>A = 28,920 B = 49,920 C = 1,980 E = -2,323 CD= 61,900</p>	<p>RE56310000 -STD RE56310050 -0,50</p> <p>1,200 (500) NitB S IF 1,500 (508) P 2,500 (700) Cr P S</p>	<p>ø17,0 x 52,0</p>			
<p>ø76,51</p> <p>4 Cyl. Diesel 1588 cc 59 Kw (80 Ps) 23:1 RA SBDE</p> <p><u>1989 - 1993</u></p> <p>Golf Jetta Passat 1989 - 1993</p>	<p>18-7081140 STD -mm 18-7081143 0,50 mm 18-7081148 1,00 mm</p>	<p>A = 41,700 B = 71,700 C = 1,600</p> <p>Ring Carrier Hard Anodising Steel Support Oil Cut-Out</p>	<p>RE56100000 -STD RE56100050 -0,50 RE56100100 -1,00</p> <p>1,750 (500) CrB Fe S 2,000 (501) P IFU 3,000 (604) Cr</p>	<p>ø24,0 x 64,0</p>			<p>1. Notch 1.53 mm Gasket +0,66 +0,80</p> <p>2. Notch 1.57 mm Gasket +0,81 +0,90</p> <p>3. Notch 1.61 mm Gasket +0,91 +1,02</p>

Engine	Ref. No. - Kit 1	Dimensions	Rings	Pin	Piston Liner	Kit 2	Info
<p>ø79,50</p> <p>3 Cyl. Diesel 1422 cc 55 Kw (75 Ps) 19.5:1 AMF BAY BWB BHC BNV <u>1999 -....</u></p> <p><u>1. & 2. Sil.</u> Polo 1.4 Tdi Lupo 1.4 Tdi Fox 1.4 Tdi Fabia 1.4 Tdi</p>	<p>18-7050880 STD -mm 18-7050883 0,50 mm</p>	<p>A = 45,800 B = 69,800 C = 17,650 E = -1,100 CD= 37,900</p> <p>Ring Carrier Oil Cut-Out Bushing</p>	<p>RE56160000 -STD RE56160050 -0,50 RE56160100 -1,00</p> <p>1,750 (500) CrB Fe S 2,000 (501) P IFU 3,000 (604) Cr P S</p>	<p>ø26,0 x 63,0</p>			<p>1,53 mm Gasket + 0,81 + 0,96</p> <p>1,57 mm Gasket + 0,96 + 1,01</p> <p>1,61 mm Gasket + 1,01 + 1,03</p>
<p>ø79,50</p> <p>3 Cyl. Diesel 1422 cc 55 Kw (75 Ps) 19.5: AMF <u>1999 -....</u></p> <p><u>3. Sil.</u> Polo 1.4 Tdi Lupo 1.4 Tdi Fox 1.4 Tdi Fabia 1.4 TDi</p>	<p>18-7050890 STD -mm 18-7050893 0,50 mm</p>	<p>A = 45,800 B = 69,800 C = 17,650 E = -1,100 CD= 37,900</p> <p>Ring Carrier Oil Cut-Out Bushing</p>	<p>RE56160000 -STD RE56160050 -0,50 RE56160100 -1,00</p> <p>1,750 (500) CrB Fe S 2,000 (501) P IFU 3,000 (604) Cr P S</p>	<p>ø26,0 x 63,0</p>			<p>1,53 mm Gasket + 0,81 + 0,96</p> <p>1,57 mm Gasket + 0,96 + 1,01</p> <p>1,61 mm Gasket + 1,01 + 1,03</p>

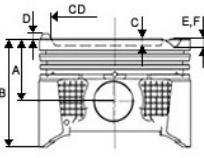
Engine	Ref. No. - Kit 1	Dimensions	Rings	Pin	Piston Liner	Kit 2	Info
<p>ø79,50</p> <p>4/5 Cyl. Diesel 1896 cc 44 Kw (60 Ps) 22.5:1</p> <p>ADG AEF BGG 1 X 1 Y(4 CY) AAB AJA (5 CYL)</p> <p><u>1990 - 1995</u></p> <p><i>Golf Polo Passat Caddy Transporter T4 Audi 80 1.9D Audi 100 2.4D Skoda Felica 1.9D</i></p>	<p>18-7050920 STD -mm 18-7050923 0,50 mm 18-7050928 1,00 mm</p>	<p>A = 39,650 B = 65,700 C = 1,900</p> <p>Ring Carrier Steel Support Oil Cut-Out</p>	<p>RE56160000 -STD RE56160050 -0,50 RE56160100 -1,00</p> <p>1,750 (500) CrB Fe S 2,000 (501) P IFU 3,000 (604) Cr P S</p>	<p>ø24,0 x 64,0</p>			<p>1. Notch 1.53 mm Gasket + 0,66 + 0,86</p> <p>2. Notch 1.57 mm Gasket + 0,87 + 0,90</p> <p>3. Notch 1.61 mm Gasket + 0,91 + 1,02</p>
<p>ø79,50</p> <p>4 Cyl. Diesel 1896 cc 50 Kw (68 Ps) 22.5:1</p> <p>AAZ ABL ADE</p> <p><u>1992 -....</u></p> <p><i>Transporter T4 Passat 1.9 TD Golf III 1.9 TD Vento 1.9 TD Audi 80 1.9 TD</i></p>	<p>18-7050940 STD -mm 18-7050943 0,50 mm 18-7050948 1,00 mm</p>	<p>A = 45,650 B = 71,700 C = 1,900</p> <p>Ring Carrier Hard Anodising Steel Support Oil Cut-Out</p>	<p>RE56330000 -STD RE56330050 -0,50 RE56330100 -1,00</p> <p>1,750 (500) CrB Fe S 2,000 (501) Cr P IFU 3,000 (604) Cr P S</p>	<p>ø26,0 x 66,0</p>			<p>1. Notch 1.53 mm Gasket +0,66 +0,86</p> <p>2. Notch 1.57 mm Gasket +0,87 +0,90</p> <p>3. Notch 1.61 mm Gasket +0,91 +1,02</p>

							
Engine	Ref. No. - Kit 1	Dimensions	Rings	Pin	Piston Liner	Kit 2	Info
<p>ø79,50</p> <p>4 Cyl. Diesel 1896 cc 66 Kw (90 Ps) 19.5:1 1Z AGD AEY AHH AHU AFN AHF <u>1993 - 1997</u></p> <p>1. & 2. Sil. Vento 1.9 Tdi Passat 1.9 Tdi Bora 1.9 Tdi Golf III 1.9 Tdi A3 I 1.9 Tdi A4 1.9 Tdi A6 1.9 Tdi Cabriolet 1.9 Tdi Audi 80 1.9 Tdi Skoda Sperrb Tdi Skoda Octavia Tdi</p> 	<p>18-7050950 STD -mm 18-7050953 0,50 mm</p>	<p>A = 45,800 B = 71,800 C = 17,650 E = -1,100 CD= 37,900</p> <p>Ring Carrier Oil Cut-Out Bushing</p>	<p>RE56160000 -STD RE56160050 -0,50 RE56160100 -1,00</p> <p>1,750 (500) CrB Fe S 2,000 (501) P IFU 3,000 (604) Cr P S</p>	<p>ø26,0 x 66,0</p>			<p>1. Notch 1.45 mm Gasket + 0,91 + 1,00</p> <p>2. Notch 1.53 mm Gasket + 1,00 + 1,10</p> <p>3. Notch 1.61 mm Gasket + 1,10 + 1,20</p>
<p>ø79,51</p> <p>4 Cyl. Diesel 1896 cc 66 Kw (90 Ps) 19.5:1 1Z AGD AEY AHH AHU AFN AHF <u>1993 - 1997</u></p> <p>3. & 4. Sil. Vento 1.9 Tdi Passat 1.9 Tdi Bora 1.9 Tdi Golf III 1.9 Tdi A3 I 1.9 Tdi A4 1.9 Tdi A6 1.9 Tdi Cabriolet 1.9 Tdi Audi 80 1.9 Tdi Skoda Sperrb Tdi Skoda Octavia Tdi</p> 	<p>18-7050960 STD -mm 18-7050963 0,50 mm</p>	<p>A = 45,800 B = 71,800 C = 17,650 E = -1,100 CD= 37,900</p> <p>Ring Carrier Oil Cut-Out Bushing</p>	<p>RE56160000 -STD RE56160050 -0,50 RE56160100 -1,00</p> <p>1,750 (500) CrB Fe S 2,000 (501) P IFU 3,000 (604) Cr P S</p>	<p>ø26,0 x 66,0</p>			<p>1. Notch 1.45 mm Gasket + 0,91 + 1,00</p> <p>2. Notch 1.53 mm Gasket + 1,00 + 1,10</p> <p>3. Notch 1.61 mm Gasket + 1,10 + 1,20</p>

Engine	Ref. No. - Kit 1	Dimensions	Rings	Pin	Piston Liner	Kit 2	Info
<p>ø79,50</p> <p>4 Cyl. Diesel 1598cc 77KW 105HP CLHA CLHB CRKB <u>2010 -.....</u></p> <p>A3 1.6 TDI 16V GOLF VII 1.6 TDI Leon 1.6 TDI Octavia 1.6 TDI 2010 -</p>	<p>18-7092090 STD -mm 18-7092093 0,50 mm</p>	<p>A = 45,300 B = 68,130 CD= 49,000</p> <p>Ring Carrier Oil Gallery Oil Cut-Out</p>	<p>RE56140000 -STD RE56140050 -0,50</p> <p>1,750 (500) Cr P 2,000 (501) P IF 2,000 (604) Nit S</p>	<p>ø26,0 x 66,0</p>			
<p>ø79,51</p> <p>4 Cyl. Diesel 1896 cc 66 Kw (90 Ps) 19.5:1 1Z AGD AEY AHH AHU AFN AHF <u>1993 - 1997</u></p> <p>3. & 4. Sil. Vento 1.9 Tdi Passat 1.9 Tdi Bora 1.9 Tdi Golf III 1.9 Tdi A3 I 1.9 Tdi A4 1.9 Tdi A6 1.9 Tdi Cabriolet 1.9 Tdi Audi 80 1.9 Tdi Skoda Sporb Tdi Skoda Octavia Tdi</p>	<p>18-7050960 STD -mm 18-7050963 0,50 mm</p> 	<p>A = 45,800 B = 71,800 C = 17,650 E = -1,100 CD= 37,900</p> <p>Ring Carrier Oil Cut-Out Bushing</p>	<p>RE56160000 -STD RE56160050 -0,50 RE56160100 -1,00</p> <p>1,750 (500) CrB Fe S 2,000 (501) P IFU 3,000 (604) Cr P S</p>	<p>ø26,0 x 66,0</p>			<p>1. Notch 1.45 mm Gasket + 0,91 + 1,00</p> <p>2. Notch 1.53 mm Gasket + 1,00 + 1,10</p> <p>3. Notch 1.61 mm Gasket + 1,10 + 1,20</p>



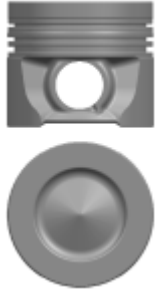



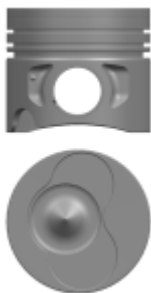

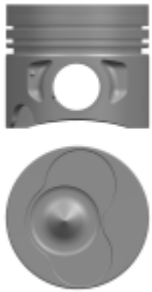
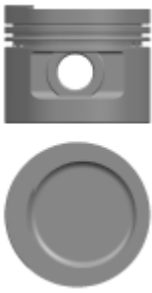
							
Engine	Ref. No. - Kit 1	Dimensions	Rings	Pin	Piston Liner	Kit 2	Info
<p>ø79,51</p> <p>3/4 Cyl. Diesel 1598cc 55 Kw 75 ps CFWA CAYA <u>2009 -.....</u></p> <p><i>Polo 1.2 Tdi (3 cyl) Polo 1.6 TDI 16V 4 cyl 2009 - 2014</i></p>	<p>18-7092500 STD -mm 18-7092503 0,50 mm</p>	<p>A = 45,300 B = 67,900 C = 10,700 CD= 49,000</p> <p>Ring Carrier Oil Gallery</p>	<p>RE56160000 -STD RE56160050 -0,50 RE56160100 -1,00</p> <p>1,750 (500) CrB Fe S 2,000 (501) P IFU 3,000 (604) Cr P S</p>	<p>ø26,0 x 66,0</p>			
<p>ø79,51</p> <p>4 Cyl. Diesel 1896 cc 74 Kw (101 Ps) AVQ ATD AXR AVB BJB SERISI OIL GALERY VAR <u>2004 -.....</u></p> <p><i>1.ve 2. Sil. Caddy III TDI Touran TDI Bora TDI Golf TDI Polo TDI Passat TDI</i></p>	<p>18-7092750 STD -mm 18-7092753 0,50 mm</p>	<p>A = 45,800 B = 68,800 C = 17,100 E = -0,650 CD= 38,000</p> <p>Ring Carrier Oil Gallery Oil Cut-Out Bushing</p>	<p>RE56330000 -STD RE56330050 -0,50 RE56330100 -1,00</p> <p>1,750 (500) CrB Fe S 2,000 (501) Cr P IFU 3,000 (604) Cr P S</p>	<p>ø25,0 x 69,8</p>			<p>1,45 mm Gasket +0,91 +1,00</p> <p>1,53 mm Gasket +1,01 +1,10</p> <p>1,61 mm Gasket +1,11 +1,20</p>



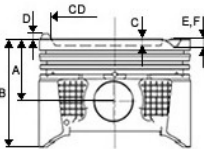

Engine	Ref. No. - Kit 1	Dimensions	Rings	Pin	Piston Liner	Kit 2	Info
<p>ø79,51</p> <p>4 Cyl. Diesel 1896 cc 74 Kw (101 Ps) AVQ ATD AXR AVB BJB SERISI OIL GALERY VAR</p> <p><u>2004 -....</u></p> <p>3.ve 4. Sil. Caddy III TDI Touran TDI Bora TDI Golf TDI Polo TDI Passat TDI</p>	<p>18-7092760 STD -mm 18-7092763 0,50 mm</p>	<p>A = 45,800 B = 68,800 C = 17,100 E = -0,650 CD= 38,000</p> <p>Ring Carrier Oil Gallery Oil Cut-Out Bushing</p>	<p>RE56330000 -STD RE56330050 -0,50 RE56330100 -1,00</p> <p>1,750 (500) CrB Fe S 2,000 (501) Cr P IFU 3,000 (604) Cr P S</p>	<p>ø26,0 x 66,0</p>			<p>1,45 mm Gasket +0,91 +1,00</p> <p>1,53 mm Gasket +1,01 +1,10</p> <p>1,61 mm Gasket +1,11 +1,20</p>
<p>ø79,51</p> <p>4 Cyl. Diesel 1896 cc 110 Kw (150 Ps) ARL ASZ AXB AXC AXB EUR3</p> <p><u>2000 -....</u></p> <p>1. & 2. Sil. Bora PDI Golf PDI Bora TDI Golf TDI Multi Van Transporter Transporter TDI</p>	<p>18-7092770 STD -mm 18-7092773 0,50 mm</p>	<p>A = 45,800 B = 68,800 C = 17,900 E = -1,100 CD= 38,000</p> <p>Ring Carrier Oil Gallery Oil Cut-Out Bushing</p>	<p>RE56160000 -STD RE56160050 -0,50 RE56160100 -1,00</p> <p>1,750 (500) CrB Fe S 2,000 (501) P IFU 3,000 (604) Cr P S</p>	<p>ø26,0 x 66,0</p>			<p>1,45 mm Gasket +0,91 +1,00</p> <p>1,53 mm Gasket +1,01 +1,10</p> <p>1,61 mm Gasket +1,11 +1,20</p>



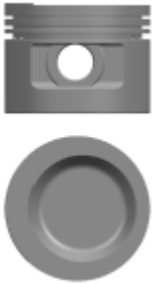
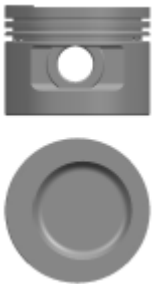

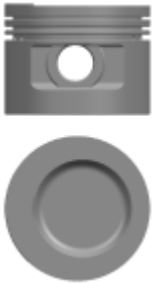







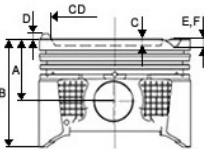





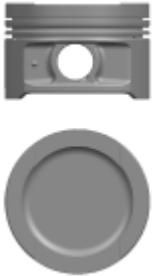

Engine	Ref. No. - Kit 1	Dimensions	Rings	Pin	Piston Liner	Kit 2	Info
<p>ø79,51</p> <p>4 Cyl. Diesel 1896 cc 110 Kw (150 Ps) ARL ASZ AXB AXC AXB EUR3 <u>2000 -....</u></p> <p><i>3. & 4. Sil. Borg PDI Golf PDI Borg TDI Golf TDI Multi Van Transporter Transporter TDI</i></p> 	<p>18-7092780 STD -mm 18-7092783 0,50 mm</p>	<p>A = 45,800 B = 68,800 C = 17,900 E = -1,100 CD= 38,000</p> <p>Ring Carrier Oil Gallery Oil Cut-Out Bushing</p>	<p>RE56160000 -STD RE56160050 -0,50 RE56160100 -1,00</p> <p>1,750 (500) CrB Fe S 2,000 (501) P IFU 3,000 (604) Cr P S</p>	<p>ø26,0 x 66,0</p>			
<p>ø81,00</p> <p>R 4 Petrol, 1595 cm³ 53/55 kW (72/75 hp) ABN DT EW EZ ABX ACR DTA EZA HM <u>1991 -....</u></p> <p><i>Golf Jetta Passat Audi 80 1.6</i></p> 	<p>14-7010160 STD -mm 14-7010163 0,50 mm</p>	<p>A = 35,600 B = 58,500 C = 2,300 D = 0,700</p>	<p>RE56180000 -STD RE56180050 -0,50 RE56180100 -1,00</p> <p>1,500 (500) CrB S IF 1,750 (508) P 3,000 (700) Cr P S</p>	<p>ø20,0 x 57,0</p>			

							
Engine	Ref. No. - Kit 1	Dimensions	Rings	Pin	Piston Liner	Kit 2	Info
<p>ø81,00</p> <p>R 4 Petrol, 1781 cm³ 55 kW (75 hp) AMM ANN ACC ADD RP</p> <p><u>1983 - 1996</u></p> <p><i>Golf I 1,8 Jetta II 1,8 Passat 1,8 Audi 80 1,8 audi 80 1,8 cc Audi 80 1,8 s Audi 100 1,8 Audi Coupe 1,8 Audi Coupe 1,8 GT</i></p> 	<p>18-7010170 STD -mm 18-7010173 0,50 mm</p>	<p>A = 32,200 B = 62,500 C = 8,100 D = 1,300 CD= 56,800</p>	<p>RE56190000 -STD RE56190050 -0,50</p> <p>1,500 (500) CrB S IF 1,750 (508) P 3,000 (604) Cr</p>	<p>ø20,0 x 57,0</p>			
<p>ø81,00</p> <p>R 5 Petrol, 2226 cm³ 101 kW (137 hp), 10:1 HY KV JT KX KM</p> <p><u>1984 - 1990</u></p> <p><i>Passat</i></p> 	<p>14-7010200 STD -mm</p>	<p>A = 32,200 B = 62,300 C = 4,600 D = 1,100 CD= 60,000</p> <p>Steel Support</p>	<p>RE56180000 -STD RE56180050 -0,50 RE56180100 -1,00</p> <p>1,500 (500) CrB S IF 1,750 (508) P 3,000 (700) Cr P S</p>	<p>ø20,0 x 57,0</p>			

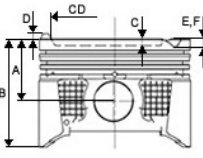
Engine	Ref. No. - Kit 1	Dimensions	Rings	Pin	Piston Liner	Kit 2	Info
<p>ø81,00</p> <p>4 Cyl. Gasoline 1781 cc 72 Kw (98 Ps) ABS ADZ DS DX DZ EV GZ HT</p> <p><u>1988 - 1991</u></p> <p><i>Golf I 1,8i Jetta II 1,8 Passat 1,8 Audi 80 1.8 Audi 100 1.8 Quattro Coupe 1.8 GT</i></p> 	<p>18-7010210 STD -mm 18-7010213 0,50 mm</p>	<p>A = 32,200 B = 62,500 C = 5,700 D = 1,300 CD= 55,700</p> <p>Steel Support</p>	<p>RE56190000 -STD RE56190050 -0,50</p> <p>1,500 (500) CrB S IF 1,750 (508) P 3,000 (604) Cr</p>	<p>ø20,0 x 57,0</p>			
<p>ø81,00</p> <p>4 Cyl. Gasoline 1781 cc 110 Kw (150 Ps) AEB AGU AJH ANB APH APU AQA ARZ AVC</p> <p><u>1996 -....</u></p> <p><i>Golf VI 1,8 t Bora 1,8 t Passat 1,8 t Audi A3 I 1,8 T Audi A4 1,8 T Audi A6 1,8 T Audi TT 1,8 T Skoda Octavia Turbo</i></p> 	<p>18-7010220 STD -mm 18-7010221 0,25 mm 18-7010223 0,50 mm</p>	<p>A = 32,700 B = 53,700 C = 1,500 CD= 70,200</p>	<p>RE56380000 -STD RE56380025 -0,25 RE56380050 -0,50 RE56380100 -1,00</p> <p>1,500 (500) CrBFeSIF 1,750 (508) P 2,000 (700) Nits</p>	<p>ø20,0 x 59,0</p>			







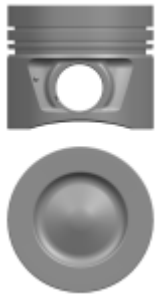

Engine	Ref. No. - Kit 1	Dimensions	Rings	Pin	Piston Liner	Kit 2	Info
<p>ø81,00</p> <p>4 Cyl. Gasoline 1781 cc 92 Kw (125 Ps) AGN APT ARG <u>1996 -....</u></p> <p><i>Golf VI 1,8 Bora 1,8 Passat 1,8 Audi A3 1,8 l Audi A4 1,8 Audi A6 1,8 Audi Cabriolet 1,8 l Skoda Octavia 20v</i></p>	<p>18-7010230 STD -mm 18-7010233 0,50 mm</p>	<p>A = 32,550 B = 56,550 E = -3,300</p> <p>Oil Cut-Out</p>	<p>RE56380000 -STD RE56380025 -0,25 RE56380050 -0,50 RE56380100 -1,00</p> <p>1,500 (500) CrBFeSIF 1,750 (508) P 2,000 (700) NitS</p>	<p>ø20,0 x 59,0</p>			
<p>ø81,00</p> <p>4 Cyl. Gasoline 1781cc 110 Kw (150 Hp) ARX AUM AUQ AWM AWP AWT AWU AWV BJX BKF BNU AWP BE <u>2000 - 2001</u></p> <p><i>Leon Toledo Ibiza Octavia Bora Golf IV Passat Jetta New Beetle</i></p>	<p>18-7010250 STD -mm 18-7010253 0,50 mm</p>	<p>A = 32,700 B = 53,700 C = 32,700 D = 69,200 E = -1,900 CD= 1,900</p> <p>Hard Anodising Oil Cut-Out</p>	<p>RE56380000 -STD RE56380025 -0,25 RE56380050 -0,50 RE56380100 -1,00</p> <p>1,500 (500) CrBFeSIF 1,750 (508) P 2,000 (700) NitS</p>	<p>ø19,0 x 50,0</p>			



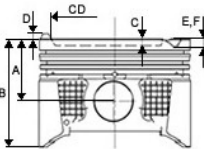





							
Engine	Ref. No. - Kit 1	Dimensions	Rings	Pin	Piston Liner	Kit 2	Info
<p>ø81,00</p> <p>4 Cyl. Gasoline 1595 cc 75 Kw (102 Ps) ADP AEH AEK AFT AHL AKL</p> <p><u>1996 - 1997</u></p> <p><i>Golf VI 1,6 Golf III 1,6 Passat 1,6 Vento 1,6 Audi A3cl 1,6 l Audi A4 1,6 Skoda Octavia</i></p> 	<p>18-7010350 STD -mm 18-7010353 0,50 mm</p>	<p>A = 32,000 B = 53,700 C = 3,000 E = -0,700 CD= 62,500</p>	<p>RE56370000 -STD RE56370050 -0,50 RE56370100 -1,00</p> <p>1,200 (500) NitB S IF 1,500 (508) P 2,000 (700) Nit S</p>	<p>ø20,0 x 57,0</p>			
<p>ø81,00</p> <p>R 5 Diesel, 2461 cm³ 88 kW (120 hp) AAT ABP AEL 1 T</p> <p><u>1991-1996</u></p> <p><i>1. & 2. Sil. Audi 100 Tdi Audi A6 Tdi</i></p> 	<p>14-7050860 STD -mm 14-7050863 0,50 mm</p>	<p>A = 45,750 B = 69,750 C = 17,250 E = -1,350</p> <p>Ring Carrier Bushing</p>	<p>RE12120000 -STD RE12120050 -0,50</p> <p>2,500 (500) Cr P 2,000 (501) P 3,000 (604) Cr P</p>	<p>ø26,0 x 68,0</p>			

							
Engine	Ref. No. - Kit 1	Dimensions	Rings	Pin	Piston Liner	Kit 2	Info
<p>ø81,00</p> <p>R 5 Diesel, 2461 cm³ 88 kW (120 hp) AAT ABP AEL 1 T <u>1991-1996</u> 3.&4.&5.Sil. Audi 100 Tdi Audi A6 Tdi</p>	<p>14-7050870 STD -mm 14-7050873 0,50 mm</p>	<p>A = 45,750 B = 69,750 C = 17,250 E = -1,350 CD= 39,600</p> <p>Ring Carrier Bushing</p>	<p>RE12120000 -STD RE12120050 -0,50</p> <p>2,500 (500) Cr P 2,000 (501) P 3,000 (604) Cr P</p>	<p>ø26,0 x 68,0</p>			
<p>ø81,00</p> <p>4 Cyl. Diesel 2459cc 105 Kw (145 Ps) AZV CBAA CFFA <u>2007 -....</u> A3 II 2.0 TDI CRAFTER 2.0 TDI Q5 2005-2012...</p>	<p>18-7094250 STD -mm 18-7094253 0,50 mm</p>	<p>A = 45,800 B = 68,800 C = 12,700 CD= 50,900</p> <p>Ring Carrier Oil Gallery Bushing</p>	<p>RE56400000 -STD RE56400025 -0,25 RE56400050 -0,50 RE56400100 -1,00</p> <p>1,750 (500) CrB Fe S IF 2,000 (508) P 3,000 (604) Cr P</p>	<p>ø26,0 x 66,0</p>			

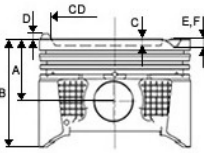
Engine	Ref. No. - Kit 1	Dimensions	Rings	Pin	Piston Liner	Kit 2	Info
<p>ø81,00</p> <p>4 Cyl. Diesel 2000 cc 100 120 KW/136 163 HP CKTC CKUC CKUB CKTB <u>2010 -....</u> Crafter 2.0 TDI Amarok 2010 -</p>	<p>18-7094400 STD -mm 18-7094403 0,50 mm</p>	<p>A = 45,800 B = 68,800 C = 13,100 CD= 50,880</p> <p>Ring Carrier Oil Gallery Oil Cut-Out Bushing</p>	<p>RE56400000 -STD RE56400025 -0,25 RE56400050 -0,50 RE56400100 -1,00</p> <p>1,750 (500) CrB Fe S IF 2,000 (508) P 3,000 (604) Cr P</p>	<p>ø26,0 x 66,0</p>			
<p>ø81,00</p> <p>4 Cyl. Diesel 1968 cc 100 KW 136 PS 16,5:1 CFHB CFHC CFHE CFJA <u>2005 -....</u> Golf VI 2.0TDI Jetta IV 2.0TDI Caddy III 2.0TDI Touran 2.0TDI 2005 -</p>	<p>18-7094490 STD -mm 18-7094493 0,50 mm</p>	<p>A = 45,800 B = 68,800 C = 12,700 CD= 50,880</p> <p>Ring Carrier Oil Gallery Oil Cut-Out Bushing</p>	<p>RE56400000 -STD RE56400025 -0,25 RE56400050 -0,50 RE56400100 -1,00</p> <p>1,750 (500) CrB Fe S IF 2,000 (508) P 3,000 (604) Cr P</p>	<p>ø26,0 x 66,0</p>			









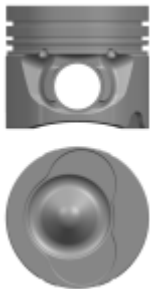

							
Engine	Ref. No. - Kit 1	Dimensions	Rings	Pin	Piston Liner	Kit 2	Info
<p>ø81,00</p> <p>4 Cyl. Diesel 1968 cc 100 103 KW/136 140 PS BGW BMM BMP BRT BSS <u>2003 -.....</u></p> <p><i>1. & 2. Sil. Caddy III BOX 2.0 TDI Golf VI 2.0 TDI Jetta III 2.0 TDI 2003 -</i></p>	<p>18-7094770 STD -mm 18-7094773 0,50 mm</p>	<p>A = 45,000 B = 68,800 C = 17,500 E = -0,700 CD= 38,000</p> <p>Ring Carrier Oil Gallery Oil Cut-Out Bushing</p>	<p>RE56400000 -STD RE56400025 -0,25 RE56400050 -0,50 RE56400100 -1,00</p> <p>1,750 (500) CrB Fe S IF 2,000 (508) P 3,000 (604) Cr P</p>	<p>ø26,0 x 66,0</p>			
<p>ø81,00</p> <p>4 Cyl. Diesel 1968 cc 100 103 KW/136 140 PS BGW BMM BMP BRT BSS <u>2003 -.....</u></p> <p><i>3. & 4. Sil. Caddy III BOX 2.0 TDI Golf VI 2.0 TDI Jetta III 2.0 TDI 2003 -</i></p>	<p>18-7094780 STD -mm 18-7094783 0,50 mm</p>	<p>A = 45,800 B = 68,800 C = 17,500 E = -0,700 CD= 38,000</p> <p>Ring Carrier Oil Gallery Oil Cut-Out Bushing</p>	<p>RE56400000 -STD RE56400025 -0,25 RE56400050 -0,50 RE56400100 -1,00</p> <p>1,750 (500) CrB Fe S IF 2,000 (508) P 3,000 (604) Cr P</p>	<p>ø26,0 x 66,0</p>			

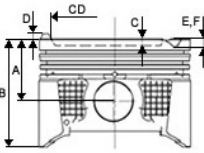
							
Engine	Ref. No. - Kit 1	Dimensions	Rings	Pin	Piston Liner	Kit 2	Info
<p>ø81,01</p> <p>4 Cyl. Diesel 1968 cc 69 Ps BDJ BDK BST <u>2004 -....</u> 1. & 2. Sil. Caddy 2.0 SDI</p>	<p>18-7050780 STD -mm 18-7050783 0,50 mm</p>	<p>A = 37,800 B = 58,800 C = 17,350 E = -0,700 CD= 38,000</p> <p>Ring Carrier</p>	<p>RE56400000 -STD RE56400025 -0,25 RE56400050 -0,50 RE56400100 -1,00</p> <p>1,750 (500) CrB Fe S IF 2,000 (508) P 3,000 (604) Cr P</p>	<p>ø22,0 x 60,0</p>			<p>1.Notch Gasket +0,91 +1,00</p> <p>2.Notch Gasket +1,01 +1,10</p> <p>3.Notch Gasket +1,11 +1,20</p>
<p>ø81,01</p> <p>4 Cyl. Diesel 1968 cc 69 Ps BDJ BDK BST <u>2004 -....</u> 3. & 4. Sil. Caddy 2.0 SDI</p>	<p>18-7050790 STD -mm 18-7050793 0,50 mm</p>	<p>A = 37,800 B = 58,800 C = 17,350 E = -0,700 CD= 38,000</p> <p>Ring Carrier</p>	<p>RE56400000 -STD RE56400025 -0,25 RE56400050 -0,50 RE56400100 -1,00</p> <p>1,750 (500) CrB Fe S IF 2,000 (508) P 3,000 (604) Cr P</p>	<p>ø22,0 x 60,0</p>			<p>1.Notch Gasket +0,91 +1,00</p> <p>2.Notch Gasket +1,01 +1,10</p> <p>3.Notch Gasket +1,11 +1,20</p>

Engine	Ref. No. - Kit 1	Dimensions	Rings	Pin	Piston Liner	Kit 2	Info
<p>ø81,01</p> <p>R 5 Gasoline, 2459 cm³ 81 kW (110 hp) ACU AVT APL AET <u>1994 - 1996</u> Transporter T4 2.5</p>	<p>14-7050800 STD -mm</p>	<p>A = 38,350 B = 64,350 C = 4,600 CD= 62,000</p>	<p>RE56170000 -STD RE56170050 -0,50 RE56170100 -1,00</p> <p>1,750 (500) CrB Fe S IF 2,000 (508) P 3,000 (700) Cr P S</p>	<p>ø24,0 x 56,0</p>			
<p>ø81,01</p> <p>5 Cyl. Diesel 2461 cc 80 Kw (109 Ps) 19.5: AVR BBR <u>2004 -....</u> A6 2.5TDI</p>	<p>18-7071770 STD -mm 18-7071773 0,50 mm</p>	<p>A = 45,800 B = 69,800 C = 16,800 E = -1,350 CD= 46,000</p> <p>Ring Carrier Oil Cut-Out Bushing</p>	<p>RE56410000 -STD RE56410050 -0,50 RE56410100 -1,00</p> <p>2,500 (500) Cr P 2,000 (501) P 3,000 (604) Cr P</p>	<p>ø26,0 x 68,0</p>			<p>0 +0,75</p> <p>1 Notch Gasket +0,87 +0,96</p> <p>2 Notch Gasket +0,97 +1,01</p> <p>3 Notch Gasket +1,02 +1,10</p>



							
Engine	Ref. No. - Kit 1	Dimensions	Rings	Pin	Piston Liner	Kit 2	Info
<p>ø81,01</p> <p>5 Cyl. Diesel 2460 cc 96/128 Kw (130 Ps) AXD AXE BLJ Euro 3 BNZ <u>2004 -....</u> <i>1. & 2. Sil. Transporter T5</i></p>	<p>18-7092820 STD -mm 18-7092823 0,50 mm</p>	<p>A = 45,750 B = 69,750 C = 18,200 E = -1,400 CD= 37,800</p> <p>Ring Carrier Oil Gallery Oil Cut-Out Bushing</p>	<p>RE56410000 -STD RE56410050 -0,50 RE56410100 -1,00</p> <p>2,500 (500) Cr P 2,000 (501) P 3,000 (604) Cr P</p>	<p>ø26,0 x 66,0</p>			<p>1 Notch Gasket +0,80 +0,90</p> <p>2 Notch Gasket +0,90 +1,00</p> <p>3 Notch Gasket +1,00 +1,10</p>
<p>ø81,01</p> <p>5 Cyl. Diesel 2460 cc 96/128 Kw (130 Ps) AXD AXE BLJ Euro 3 BNZ <u>2004 -....</u> <i>3,4. & 5.Sil. Transporter T5</i></p>	<p>18-7092830 STD -mm 18-7092833 0,50 mm</p>	<p>A = 45,750 B = 69,750 C = 18,200 E = -1,400 CD= 37,800</p> <p>Ring Carrier Oil Gallery Oil Cut-Out Bushing</p>	<p>RE56410000 -STD RE56410050 -0,50 RE56410100 -1,00</p> <p>2,500 (500) Cr P 2,000 (501) P 3,000 (604) Cr P</p>	<p>ø26,0 x 66,0</p>			<p>1 Notch Gasket +0,80 +0,90</p> <p>2 Notch Gasket +0,90 +1,00</p> <p>3 Notch Gasket +1,00 +1,10</p>

Engine	Ref. No. - Kit 1	Dimensions	Rings	Pin	Piston Liner	Kit 2	Info
<p>ø81,01</p> <p>4 Cyl. Diesel 2000 cc 140 Ps BKP BVE BMA BMN BMR BUZ BWV <u>2005 -....</u></p> <p><i>Passat 2.0 TDi Jetta 2.0 TDi Golf V 2.0 TDi</i></p>	<p>18-7092840 STD -mm 18-7092843 0,50 mm</p>	<p>A = 45,800 B = 68,800 C = 17,800 CD= 38,000</p> <p>Ring Carrier Oil Gallery Oil Cut-Out Bushing</p>	<p>RE56400000 -STD RE56400025 -0,25 RE56400050 -0,50 RE56400100 -1,00</p> <p>1,750 (500) CrB Fe S IF 2,000 (508) P 3,000 (604) Cr P</p>	<p>ø26,0 x 66,0</p>			
<p>ø81,01</p> <p>5 Cyl. Diesel 2459cc 100 Kw (136 Ps) BJM CECB BJL Euro4 BJM Euro4 CECA Euro5 <u>2006 -....</u></p> <p><i>LT 28 LT 35 LT 46 Crafter-LT 28 D LT 35 D LT 46 D</i></p>	<p>18-7092850 STD -mm 18-7092853 0,50 mm</p>	<p>A = 45,750 B = 69,750 C = 16,600 E = -1,350 CD= 45,900</p> <p>Ring Carrier Oil Gallery Oil Cut-Out Bushing</p>	<p>RE56410000 -STD RE56410050 -0,50 RE56410100 -1,00</p> <p>2,500 (500) Cr P 2,000 (501) P 3,000 (604) Cr P</p>	<p>ø26,0 x 66,0</p>			

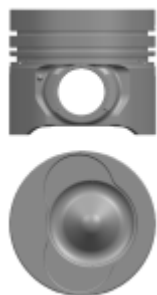
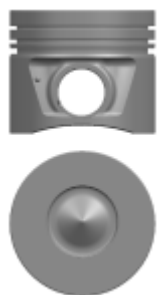

Engine	Ref. No. - Kit 1	Dimensions	Rings	Pin	Piston Liner	Kit 2	Info
<p>ø81,01</p> <p>4 Cyl. Diesel 1968 cc 89 120KW/121 170 HP BKD BLB BNA BMN</p> <p><u>2003 -....</u></p> <p><i>GOLF V 2.0 TDI JETTA III 2.0 TDI TOURAN 2.0 TDI 2003 -</i></p>	<p>18-7094670 STD -mm 18-7094673 0,50 mm</p>	<p>A = 48,800 B = 69,800 C = 17,800 CD= 38,000</p> <p>Ring Carrier Oil Gallery Oil Cut-Out Bushing</p>	<p>RE56400000 -STD RE56400025 -0,25 RE56400050 -0,50 RE56400100 -1,00</p> <p>1,750 (500) CrB Fe S IF 2,000 (508) P 3,000 (604) Cr P</p>	<p>ø26,0 x 66,0</p>			
<p>ø82,50</p> <p>4 Cyl. Gasoline 1781cc/1791cc 88/118/125kw 120/160170ps BZB BYT CABA CABB CABD</p> <p><u>2006 - 2008</u></p> <p><i>A3 1.8 TFSI 16V</i></p>	<p>18-7010400 STD -mm 18-7010403 0,50 mm</p>	<p>A = 29,800 B = 55,980 C = 4,750 D = 6,000 E = -2,000 CD= 67,000</p> <p>Ring Carrier</p>	<p>RE12160000 -STD RE12160025 -0,25 RE12160050 -0,50 RE12160100 -1,00</p> <p>1,200 (500) NitB S IF 1,500 (501) P 2,000 (700) Cr P S</p>	<p>ø21,0 x 53,0</p>			

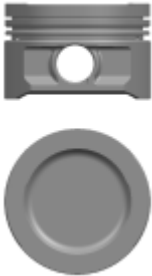
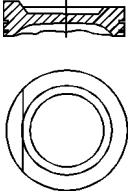





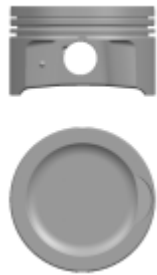

Engine	Ref. No. - Kit 1	Dimensions	Rings	Pin	Piston Liner	Kit 2	Info
<p>ø82,50</p> <p>V 6 Petrol, 2597 cm³ 110 kW (150 hp), 10:1 ABC ACZ <u>1994 - 1998</u></p> <p><i>Audi 80 2.6</i> <i>Audi 100 2.6</i> <i>Audi A4 2.6</i> <i>Audi A6 2.6</i></p> 	<p>14-7010410 STD -mm 14-7010413 0,50 mm</p>	<p>A = 33,500 B = 54,200 C = 3,000 D = 0,700 CD= 61,800</p>	<p>RE12140000 -STD RE12140050 -0,50</p> <p>1,500 (500) CrB Fe S IF 1,750 (508) P 3,000 (700) Cr P S</p>	<p>ø21,0 x 24,6</p>			
<p>ø82,50</p> <p>4 Cyl. Gasoline 1984 cc 85 Kw (115 Ps) 10.4 AAD ABK <u>1990 - 1994</u></p> <p><i>Audi 80 2.0 E</i> <i>Audi 100 2.0 E</i> <i>Audi A6 2.0</i> <i>Cabriolet 2.0 I</i></p> 	<p>18-7010420 STD -mm 18-7010423 0,50 mm</p>	<p>A = 30,900 B = 63,900 C = 5,000 D = 0,900 CD= 63,800</p> <p>Oil Cut-Out</p>	<p>RE12160000 -STD RE12160025 -0,25 RE12160050 -0,50 RE12160100 -1,00</p> <p>1,200 (500) NitB S IF 1,500 (501) P 2,000 (700) Cr P S</p>	<p>ø21,0 x 61,0</p>			

Engine	Ref. No. - Kit 1	Dimensions	Rings	Pin	Piston Liner	Kit 2	Info
<p>ø82,50</p> <p>6 Cyl. Gasoline 2771 cc 128 Kw (174 Ps) AAH AFC AEJ <u>1990 - 1997</u></p> <p><i>Audi 80 2.8</i> <i>Audi 100 2.8</i> <i>Audi A4 2.8</i> <i>Audi A6 2.8</i> <i>Audi A8 2.8</i></p>	<p>14-7010430 STD -mm 14-7010433 0,50 mm</p>	<p>A = 30,800 B = 52,500 C = 4,250 CD= 61,500</p>	<p>RE12160000 -STD RE12160025 -0,25 RE12160050 -0,50 RE12160100 -1,00</p> <p>1,200 (500) NitB S IF 1,500 (501) P 2,000 (700) Cr P S</p>	<p>ø21,0 x 56,0</p>			
<p>ø82,50</p> <p>R 5 Petrol, 2309 cm³ 98 kW (133 hp), 10:1 AAR NF NG <u>1990 - 1996</u></p> <p><i>Audi 80 2.3 E</i> <i>Audi 100 2.3 E</i> <i>Audi 2.3</i> <i>Audi A6 2.3</i></p>	<p>14-7010440 STD -mm 14-7010443 0,50 mm</p>	<p>A = 32,200 B = 54,300 C = 4,400 D = 1,100 CD= 60,000</p>	<p>RE12140000 -STD RE12140050 -0,50</p> <p>1,500 (500) CrB Fe S IF 1,750 (508) P 3,000 (700) Cr P S</p>	<p>ø20,0 x 68,0</p>			

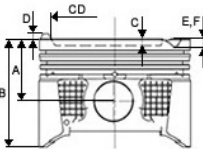

Engine	Ref. No. - Kit 1	Dimensions	Rings	Pin	Piston Liner	Kit 2	Info
<p>ø82,50</p> <p>4 Cyl. Gasoline 1984 cc 96 KW 131 PS ALT <u>2000-....</u></p> <p><i>Passat 2.0i 20V</i> <i>2000-....</i></p>	<p>18-7010480 STD -mm 18-7010483 0,50 mm</p>	<p>A = 29,600 B = 50,600 C = 2,600 CD= 64,000</p>	<p>RE12160000 -STD RE12160025 -0,25 RE12160050 -0,50 RE12160100 -1,00</p> <p>1,200 (500) NitB S IF 1,500 (501) P 2,000 (700) Cr P S</p>	<p>ø19,0 x 44,0</p>			
<p>ø82,50</p> <p>4 Cyl. Gasoline 1984 cc 110 Kw (150 PS) BLR <u>2004-....</u></p> <p><i>Golf 2.0 FSI 16V</i> <i>Jetta 2.0 FSI 16V</i> <i>Passat 2.0 FSI 16V</i> <i>2004-....</i></p>	<p>18-7051470 STD -mm 18-7051473 0,50 mm</p>	<p>A = 29,400 B = 47,400 C = 7,360 D = 12,460 E = -1,980</p> <p>Hard Anodising</p>	<p>RE56370000 -STD RE56370050 -0,50 RE56370100 -1,00</p> <p>1,200 (500) NitB S IF 1,500 (508) P 2,000 (700) Nit S</p>	<p>ø19,0 x 44,0</p>			



							
Engine	Ref. No. - Kit 1	Dimensions	Rings	Pin	Piston Liner	Kit 2	Info
<p>ø83,00</p> <p>6 Cyl. Diesel 2967cc 211/235/245 Ps BUN BUG BKS BSG BKN <u>2007 - 2015</u></p> <p>A6 3.0 TDI Q7 3.0 TDI 24V Touareg 1 3.0 TDI 24V</p>	<p>18-7086880 STD -mm 18-7086883 0,50 mm</p>	<p>A = 46,300 B = 70,800 C = 15,100 CD= 45,000</p> <p>Ring Carrier Oil Gallery</p>	<p>RE12280000 -STD RE12280050 -0,50</p> <p>2,000 (500) Cr P 2,000 (501) Cr IFU 3,000 (604) Cr P</p>	<p>ø30,0 x 68,0</p>			
<p>ø93,00</p> <p>4 Cyl. Diesel 2798 cc 116 Kw (158 Ps) BCQ AUH ATA AGK <u>2002 -....</u></p> <p>LT28 D LT35 D LT46 D</p>	<p>18-7086760 STD -mm 18-7086763 0,50 mm</p>	<p>A = 56,200 B = 86,200 C = 18,500 E = -1,500 CD= 47,100</p> <p>Ring Carrier Hard Anodising Oil Cut-Out</p>	<p>RE56460000 -STD RE56460050 -0,50</p> <p>2,500 (504) Cr P 2,000 (501) P IWU 3,000 (604) Cr P</p>	<p>ø35,0 x 77,0</p>			

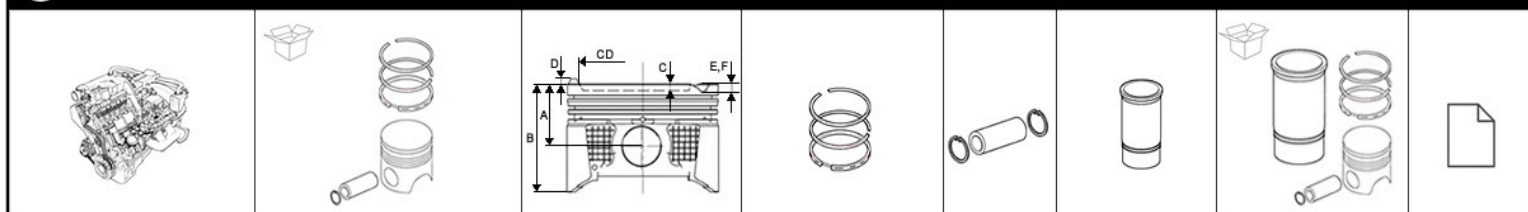

Engine Ref. No. - Kit 1 Dimensions Rings Pin Piston Liner Kit 2 Info

ø93,00

4 Cyl. Diesel 2792 cc
116 Kw (158 Ps)
AUH
BCQ
2003 -.....
LT28 D
LT35 D
LT46 D
C.Rail

18-7086770 STD -mm
18-7086773 0,50 mm

A = 56,150
B = 87,150
C = 18,500
E = -1,500
CD= 47,100







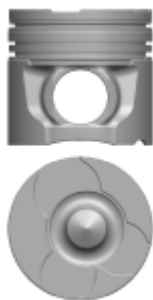

RE56460000 -STD
RE56460050 -0,50

ø35,0
x 77,0

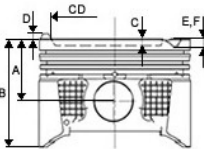







2,500 (504) Cr P
2,000 (501) P IWU
3,000 (604) Cr P

Ring Carrier
Hard Anodising
Oil Cut-Out

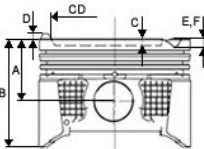











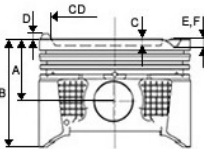





							
Engine	Ref. No. - Kit 1	Dimensions	Rings	Pin	Piston Liner	Kit 2	Info
<p>ø77,00</p> <p>4 Cyl.Gasoline 1598 cc BMW N 13 B16A MINI N18 B 16A 2010 -....</p> <p><i>BMW 116i MINI COOPER S 1.6i 16V PEUGEOT 77 MM</i></p>	<p>18-5510310 STD -mm 18-5510310-30 STD -mm 18-5510313 0,50 mm 18-5510313-30 0,50 mm</p>	<p>A = 28,500 B = 51,200 C = 3,500 D = 2,700 E = -3,300 F = -3,400 CD= 34,700</p> <p>Hard Anodising</p>	<p>RE15260000 -STD ø20,0 RE15260000_NPR -STD ø18,0 RE15260050 -0,50 RE15260050_NPR -0,50</p> <p>1,200 (500) Cr S IF 1,500 (508) P 2,000 (700) Cr P S</p>				
<p>ø77,00</p> <p>4 Cyl.Gasoline 1598 cc EP6 EP6C 2010 -....</p> <p><i>3008 16i 16V 5008 1.6i 2 207 1.6 16V 308 1.6 16V</i></p>	<p>18-5510320 STD -mm 18-5510323 0,50 mm</p>	<p>A = 27,500 B = 47,500 C = 2,000 E = -5,700 F = -3,800 CD= 56,600</p>	<p>RE15260000 -STD ø18,0 RE15260000_NPR -STD ø13,0 RE15260050 -0,50 RE15260050_NPR -0,50</p> <p>1,200 (500) Cr S IF 1,500 (508) P 2,000 (700) Cr P S</p>				

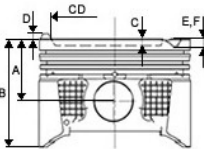

							
Engine	Ref. No. - Kit 1	Dimensions	Rings	Pin	Piston Liner	Kit 2	Info
<p>ø77,00</p> <p>4 Cyl. Gasoline 1598 cc (175PS) R55 R56 R57 <u>2007-2013</u> MINI COOPER</p>	<p>18-5510330 STD -mm 18-5510333 0,50 mm</p>	<p>A = 28,500 B = 51,200 C = 3,500 D = 2,700 E = -3,300 F = -3,400 CD= 34,700</p> <p>Hard Anodising</p>	<p>RE15260000 -STD ø20,0 RE15260000_NPR -STD ø48,0 RE15260050 -0,50 RE15260050_NPR -0,50</p> <p>1,200 (500) Cr S IF 1,500 (508) P 2,000 (700) Cr P S</p>				
<p>ø77,00</p> <p>4 Cyl. Gasoline 1598 cc S R53*/R52/JCW GP 1.6 I4 <u>2000 - 2008</u> MINI COOPER S R53 CABRIO R52 MINI COOPER S JCW/CAHLENGE</p>	<p>18-5510360 STD -mm 18-5510363 0,50 mm</p>	<p>A = 26,300 B = 47,000 C = 0,600 CD= 56,500</p> <p>Ring Carrier Hard Anodising</p>	<p>RE41010000 -STD ø21,0 RE41010050 -0,50 x 47,5</p> <p>1,200 (500) CrSIF 1,200 (508) P 2,500 (700) CrPS</p>				









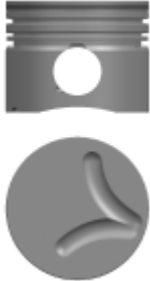

							
Engine	Ref. No. - Kit 1	Dimensions	Rings	Pin	Piston Liner	Kit 2	Info
<p>ø80,00</p> <p>6 Cyl. Gasoline 1991 cc 110 Kw (150 Ps) M50 B20 6 Sil. Benzinli 1991 cc 110 Kw (150 Ps) 1 <u>1992 - 1995</u></p> <p><i>BMW 320i Coupe 320i 520i Touring 1992/1995</i></p>	<p>14-5510210 STD -mm 14-5510213 0,50 mm 14-5510218 1,00 mm</p>	<p>A = 33,500 B = 51,000 D = 1,860 E = -2,940</p> <p>Steel Support</p>	<p>RE15150000 -STD RE15150050 -0,50 RE15150100 -1,00</p> <p>1,500 (500) Cr S IF 1,500 (508) P 2,000 (700) Nit S</p>	<p>ø22,0 x 51,0</p>			
<p>ø80,00</p> <p>6 Cyl. Gasoline 110 Kw (150 Ps) 10,5:1 M50 B20M <u>1990 -....</u></p> <p><i>BMW 320i 520i 1990 -</i></p>	<p>14-5510220 STD -mm 14-5510223 0,50 mm 14-5510228 1,00 mm</p>	<p>A = 42,400 B = 62,400 E = -1,310 F = -3,130</p> <p>Steel Support</p>	<p>RE15150000 -STD RE15150050 -0,50 RE15150100 -1,00</p> <p>1,500 (500) Cr S IF 1,500 (508) P 2,000 (700) Nit S</p>	<p>ø22,0 x 54,0</p>			

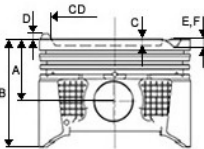







							
Engine	Ref. No. - Kit 1	Dimensions	Rings	Pin	Piston Liner	Kit 2	Info
<p>ø80,00</p> <p>6 Cyl. Gasoline 1990 cc 92 Kw (125 Ps) 9,8: M20 3.20i 5.20 i24V 150PS V6</p> <p><u>1981 - 1988</u></p> <p>BMW 320i 520i 1981/1988</p>	<p>14-5510230 STD -mm 14-5510233 0,50 mm</p>	<p>A = 43,400 B = 71,700 D = 3,300 E = -1,300</p> <p>Steel Support</p>	<p>RE15280000 -STD RE15280050 -0,50 RE15280100 -1,00</p> <p>1,500 (500) Cr S IF 2,000 (508) P 3,500 (700) Cr P S</p>	<p>ø22,0 x 61,0</p>			
<p>ø80,00</p> <p>6 Cyl. Gasoline 1991 cc 110 Kw (150 Ps) 9,8:1 M52 B20</p> <p><u>1993 -....</u></p> <p>BMW 320i (E36) 520i Z3 1993</p>	<p>14-5510240 STD -mm 14-5510243 0,50 mm</p>	<p>A = 32,200 B = 54,600 D = 1,400 E = -1,500 F = -2,800</p>	<p>RE15150000 -STD RE15150050 -0,50 RE15150100 -1,00</p> <p>1,500 (500) Cr S IF 1,500 (508) P 2,000 (700) Nit S</p>	<p>ø22,0 x 51,0</p>			

Engine	Ref. No. - Kit 1	Dimensions	Rings	Pin	Piston Liner	Kit 2	Info
<p>ø80,00</p> <p>6 Cyl. Gasoline 2171cc 141 KW / 170 PS M54B22 6 Sil. Benzinli 2171cc 141 KW 70 PS 10.8:1 <u>2000 - 2006</u> BMW 320i 2.2 24V (E46) 520i 2.2 24V (E39) 520i 2.2 24V(E60)</p>	<p>14-5510400 STD -mm 14-5510403 0,50 mm</p>	<p>A = 29,600 B = 49,500 E = -2,900 F = -3,400</p>	<p>RE15360000 -STD RE15360050 -0,50</p> <p>1,200 (500) Nit S 1,500 (508) P 2,000 (700) Nit S</p>	<p>ø22,0 x 51,0</p>			
<p>ø80,00</p> <p>R 6 Petrol, 1991 cm³ 110 kW (150 hp) M52 B(20 6 S3) Vanos M52 B(20 6 S4) <u>1993 -....</u> BMW 320 Ci 320 i 520 i Z3 2.0 1999-2003</p>	<p>18-5510420 STD -mm 18-5510423 0,50 mm</p>	<p>A = 31,700 B = 51,300 D = 2,100 E = -3,000</p> <p>Steel Support</p>	<p>RE15150000 -STD RE15150050 -0,50 RE15150100 -1,00</p> <p>1,500 (500) Cr S IF 1,500 (508) P 2,000 (700) Nit S</p>	<p>ø22,0 x 51,0</p>			

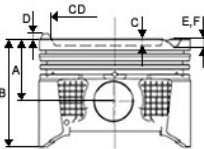







Engine	Ref. No. - Kit 1	Dimensions	Rings	Pin	Piston Liner	Kit 2	Info
<p>ø80,00</p> <p>4/6 Cyl. Diesel 1669/2498 cc 105 Kw (90/143 Ps) M41 M51 D25WA BMW <u>1990 -....</u></p> <p><i>Turbo Intercooler 318 Compact TDS/TouringSE 325 325/525 TDS/Touring 725 TDS Omega TDS Range Rover</i></p> 	<p>18-6592090 STD -mm 18-6592093 0,50 mm</p>	<p>A = 39,450 B = 62,450 C = 2,500</p> <p>Ring Carrier Oil Gallery Steel Support Oil Cut-Out</p>	<p>RE15140000 -STD RE15140050 -0,50 RE15140100 -1,00</p> <p>3,000 (504) Cr 1,750 (501) P IFU 3,000 (604) Cr</p>	<p>ø27,0 x 63,0</p>			
<p>ø84,00</p> <p>6 Cyl. Gasoline 2791 cc 141 Kw (191 Ps) M52B 28GG <u>1995 - 1998</u></p> <p><i>BMW 328i 528i 728i 1995/1998</i></p>	<p>14-5510250 STD -mm 14-5510253 0,50 mm</p>	<p>A = 31,820 B = 51,820 E = -1,550 F = -1,700</p>	<p>RE15170000 -STD RE15170050 -0,50 RE15170100 -1,00</p> <p>1,500 (500) Cr S IF 1,500 (508) P 2,000 (700) Nit S</p>	<p>ø22,0 x 56,0</p>			

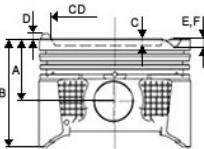

							
Engine	Ref. No. - Kit 1	Dimensions	Rings	Pin	Piston Liner	Kit 2	Info
<p>ø84,00</p> <p>4 Cyl. Gasoline 1573 cc 66 Kw (90 Ps) 8,3:1 M10B 16E21. 4 Sil. Benzinli 1573 cc 66 Kw (90 Ps) <u>1975 - 1980</u> BMW 316</p>	<p>18-5510260 STD -mm 18-5510263 0,50 mm</p>	<p>A = 46,700 B = 84,700 D = 6,000</p> <p>Steel Support</p>	<p>RE15050000 -STD RE15050050 -0,50</p> <p>1,750 (500) Cr S IF 2,000 (508) P 4,000 (603) Fe</p>	<p>ø22,0 x 69,0</p>			
<p>ø84,00</p> <p>4 Cyl. Gasoline 1596 cc 73 Kw (100 Ps) M40B 16ME <u>1988 - 1992</u> BMW Injection 316i</p>	<p>14-5510270 STD -mm 14-5510273 0,50 mm</p>	<p>A = 41,150 B = 67,150 C = 2,750 CD= 69,000</p> <p>Steel Support</p>	<p>RE15030000 -STD RE15030050 -0,50</p> <p>1,500 (500) Cr S IF 1,750 (508) P 3,000 (700) Cr P S</p>	<p>ø22,0 x 54,3</p>			







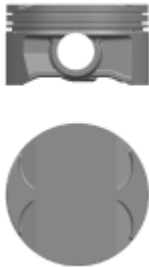





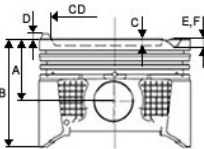





							
Engine	Ref. No. - Kit 1	Dimensions	Rings	Pin	Piston Liner	Kit 2	Info
<p>ø84,00</p> <p>4 Cyl. Gasoline 1574 cc 55 Kw (75 Ps) M10B 16V. 4 Sil. Benzinli 1574 cc 55 Kw (75 Ps) 9. <u>1981 - 1983</u></p> <p>BMW 316 1981 - 1983</p>	<p>18-5510280 STD -mm 18-5510283 0,50 mm</p>	<p>A = 47,100 B = 86,300 D = 7,200</p> <p>Steel Support</p>	<p>RE15050000 -STD RE15050050 -0,50</p> <p>1,750 (500) Cr S IF 2,000 (508) P 4,000 (603) Fe</p>	<p>ø22,0 x 69,0</p>			
<p>ø84,00</p> <p>4 Cyl. Gasoline 1795 cc 83 Kw (113 Ps) M40B 18E. 4 Sil. Benzinli 1795 cc 83 Kw (113 Ps) 8 <u>1991 - 1993</u></p> <p>BMW 318i 518i 1991/1993</p>	<p>14-5510290 STD -mm 14-5510293 0,50 mm</p>	<p>A = 31,650 B = 57,650 C = 5,330 CD= 73,000</p> <p>Steel Support</p>	<p>RE15170000 -STD RE15170050 -0,50 RE15170100 -1,00</p> <p>1,500 (500) Cr S IF 1,500 (508) P 2,000 (700) Nit S</p>	<p>ø22,0 x 52,0</p>			



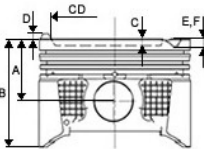





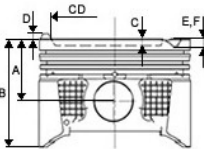

							
Engine	Ref. No. - Kit 1	Dimensions	Rings	Pin	Piston Liner	Kit 2	Info
<p>ø84,00</p> <p>4 Cyl. Gasoline 1795 cc 83 Kw (113 Ps) M40B 18E. 4 Sil. Benzinli 1795 cc 83 Kw (113 Ps) 8 <u>1987 - 1990</u></p> <p><i>BMW 318i (E30) 1987 - 1990</i></p> 	<p>18-5510350 STD -mm 18-5510353 0,50 mm</p>	<p>A = 36,650 B = 62,650 C = 6,050 CD= 70,000</p> <p>Steel Support</p>	<p>RE15030000 -STD RE15030050 -0,50</p> <p>1,500 (500) Cr S IF 1,750 (508) P 3,000 (700) Cr P S</p>	<p>ø22,0 x 54,0</p>			
<p>ø84,00</p> <p>4 Cyl. Gasoline 1796cc 85 Kw (116 PS) N42 B18 N42 B20 N45 B16 N46 B20 <u>2001 - 2004</u></p> <p><i>BMW 316 1.8i 16V (E46) 318 2.0i 16V (E46) 116 1.6i 16V (E87) 316 1.6i 16V</i></p>	<p>14-5510410 STD -mm 14-5510413 0,50 mm</p>	<p>A = 29,800 B = 50,800 E = -5,100 F = -5,200</p>	<p>RE15380000 -STD RE15380050 -0,50</p> <p>1,200 (500) Nit S IF 1,500 (508) P 2,000 (700) Nit S</p>	<p>ø20,0 x 50,0</p>			

Engine	Ref. No. - Kit 1	Dimensions	Rings	Pin	Piston Liner	Kit 2	Info
<p>ø84,00</p> <p>6 Cyl. Gasoline 2500 cc 125 170 Kw (170 231 PS) M54 B25 E39 E46. 6 Sil. Benzinli 2500 cc 125 170 <u>2000 - 2007</u></p> <p><i>BMW 325i</i> 525i X3 Z4 X5 Z3 2000 - 2007</p> 	<p>18-5510540 STD -mm 18-5510543 0,50 mm</p>	<p>A = 27,600 B = 47,600 E = -2,600</p>	<p>RE15380000 -STD RE15380050 -0,50</p> <p>1,200 (500) Nit S IF 1,500 (508) P 2,000 (700) Nit S</p>	<p>ø22,0 x 56,0</p>			
<p>ø84,00</p> <p>6 Cyl. Gasoline 2979 cc 170 Kw (231 Ps) M54 B30. 6 Sil. Benzinli 2979 cc 170 Kw (231 Ps). <u>2000 - 2006</u></p> <p><i>BMW 330 i</i> 530i 730 i X3 X5 Z4 2000 - 2006</p> 	<p>18-5510550 STD -mm 18-5510553 0,50 mm</p>	<p>A = 28,320 B = 48,320 E = -0,710</p>	<p>RE15380000 -STD RE15380050 -0,50</p> <p>1,200 (500) Nit S IF 1,500 (508) P 2,000 (700) Nit S</p>	<p>ø22,0 x 56,0</p>			









							
Engine	Ref. No. - Kit 1	Dimensions	Rings	Pin	Piston Liner	Kit 2	Info
<p>ø84,00</p> <p>4 Cyl. Gasoline 1796 cc 85 Kw (115 Ps) 9,7 1Injection,Catal.Conv M43B 18E36</p> <p><u>1993</u></p> <p>318g 518g 318i 518i Z3</p>	<p>14-5511310 STD -mm 14-5511313 0,50 mm</p>	<p>A = 31,650 B = 57,650 C = 3,030 CD= 70,300</p>	<p>RE15170000 -STD RE15170050 -0,50 RE15170100 -1,00</p> <p>1,500 (500) Cr S IF 1,500 (508) P 2,000 (700) Nit S</p>	<p>ø22,0 x 54,0</p>			
<p>ø84,00</p> <p>4 Cyl. Gasoline 1795 cc 85 Kw (115 Ps) 8,8:1Injection, Catal.Conv M40B 18ME</p> <p><u>1987 - 1990</u></p> <p>318i</p>	<p>14-5511320 STD -mm 14-5511323 0,50 mm</p>	<p>A = 31,150 B = 56,150 C = 1,190 CD= 70,000</p> <p>Steel Support</p>	<p>RE15170000 -STD RE15170050 -0,50 RE15170100 -1,00</p> <p>1,500 (500) Cr S IF 1,500 (508) P 2,000 (700) Nit S</p>	<p>ø22,0 x 54,0</p>			



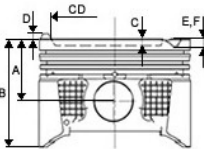





							
Engine	Ref. No. - Kit 1	Dimensions	Rings	Pin	Piston Liner	Kit 2	Info
<p>ø84,00</p> <p>4 Cyl. Diesel 1951 cc 100 Kw (136 Ps) M47D20. 4 Sil. Dizel 1951 cc 100 Kw (136 Ps) 19:1. <u>1998 -....</u></p> <p><i>BMW 320 D 520 D 1998 -</i></p>	<p>14-5592110 STD -mm 14-5592113 0,50 mm</p>	<p>A = 47,000 B = 71,000 C = 15,000 E = -1,360 F = -1,480 CD= 41,700</p> <p>Ring Carrier Oil Gallery Oil Cut-Out</p>	<p>RE15410000 -STD RE15410050 -0,50</p> <p>3,000 (504) Cr 2,000 (508) P 3,000 (604) Nit S</p>	<p>ø30,0 x 68,0</p>			<p>1. Notch Gasket + 0,80 / + 0,92</p> <p>2. Notch Gasket + 0,93 / + 1,03</p>
<p>ø84,00</p> <p>4 Cyl. Diesel 2000 cc M47N. 4 Sil. Dizel 2000 cc. <u>2001 -....</u></p> <p><i>BMW E-87 118D E-90 318 D E-91 318D 2001 -</i></p>	<p>14-5592130 STD -mm 14-5592133 0,50 mm</p>	<p>A = 39,450 B = 62,450 C = 2,500</p> <p>Ring Carrier Oil Gallery Steel Support Oil Cut-Out</p>	<p>RE15460000 -STD RE15460050 -0,50</p> <p>3,000 (504) Cr P 2,000 (508) P 2,000 (604) Nit S</p>	<p>ø30,0 x 68,0</p>			

							
Engine	Ref. No. - Kit 1	Dimensions	Rings	Pin	Piston Liner	Kit 2	Info
<p>ø84,00</p> <p>4 Cyl. Diesel 1995 cc 85/130 Kw (115/177 HP) N47D EURO 4. 4 Sil. 1995 cc Dizel 85 130 Kw (115 <u>2004 - 2011</u></p> <p><i>BMW N47D EURO 4</i> 116d 118d 120d 318d 320d 520d X3 2 0d 2004 - 2011</p>	<p>14-5592140 STD -mm 14-5592143 0,50 mm</p>	<p>A = 47,000 B = 73,000 C = 15,250 CD= 47,500</p> <p>Ring Carrier Oil Gallery Oil Cut-Out</p>	<p>RE15440000 -STD RE15440050 -0,50</p> <p>1,750 (500) Cr P 1,750 (508) P 2,000 (604) Nit S</p>	<p>ø32,0 x 64,0</p>			<p>1. Notch Gasket + 0,80 + 0,92</p> <p>2. Notch Gasket + 0,93 + 1,03</p> <p>3. Notch Gasket + 1,04 + 1,20</p>
<p>ø84,00</p> <p>6 Cyl. Diesel 3000 cc 145 Kw (197 235 Ps) M57N2 N57 <u>2006 -....</u></p> <p><i>BMW 325d</i> 330d</p>	<p>14-5592150 STD -mm</p>	<p>A = 45,000 B = 71,000 C = 14,500 E = -1,540 F = -1,600 CD= 47,500</p> <p>Ring Carrier Oil Gallery</p>	<p>RE15410000 -STD RE15410050 -0,50</p> <p>3,000 (504) Cr 2,000 (508) P 3,000 (604) Nit S</p>	<p>ø30,0 x 68,0</p>			

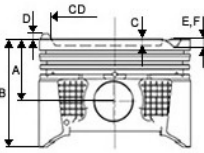







Engine	Ref. No. - Kit 1	Dimensions	Rings	Pin	Piston Liner	Kit 2	Info
<p>ø84,00</p> <p>4 Cyl. Diesel 1995cc 135 kw 181HP N47TU <u>2013 -....</u></p> <p>318d 320d 520d 525 2013....</p>	<p>18-5592160 STD -mm 18-5592161 0,25 mm 18-5592163 0,50 mm</p>	<p>A = 47,000 B = 73,000 C = 14,500 CD= 47,500</p> <p>Ring Carrier Oil Gallery</p>	<p>RE15440000 -STD RE15440050 -0,50</p> <p>1,750 (500) Cr P 1,750 (508) P 2,000 (604) Nit S</p>	<p>ø32,0 x 64,0</p>			
<p>ø84,00</p> <p>4 Cyl. Diesel 2000 cc M47N. 4 Sil. Dizel 2000 cc. <u>2001 -....</u></p> <p>BMW 320 D 320 TD E-46 320 CD 2001 -</p>	<p>14-5594110 STD -mm 14-5594113 0,50 mm</p>	<p>A = 44,870 B = 70,620 C = 13,500 E = -1,360 F = -1,480 CD= 46,900</p> <p>Ring Carrier Oil Gallery Oil Cut-Out Bushing</p>	<p>RE15410000 -STD RE15410050 -0,50</p> <p>3,000 (504) Cr 2,000 (508) P 3,000 (604) Nit S</p>	<p>ø30,0 x 68,0</p>			<p>1. Notch Gasket + 0,85 + 0,90</p> <p>2. Notch Gasket + 0,90 + 1,00</p> <p>3. Notch Gasket + 1,00 / + 1,10</p>

Engine	Ref. No. - Kit 1	Dimensions	Rings	Pin	Piston Liner	Kit 2	Info
<p>ø84,00</p> <p>4/6 Cyl. Diesel 2926 cc 135 Kw (184 Ps) M57D30 M47D20R TD6 <u>1999 -....</u></p> <p><i>Frelander Range Rover TD6 2002</i></p>	<p>18-6592960 STD -mm 18-6592963 0,50 mm</p>	<p>A = 47,000 C = 16,500 E = -1,360 F = -1,480 G = 71,000 CD= 41,550</p> <p>Ring Carrier Oil Gallery</p>	<p>RE15410000 -STD RE15410050 -0,50</p> <p>3,000 (504) Cr 2,000 (508) P 3,000 (604) Nit S</p>	<p>ø30,0 x 68,0</p>			<p>1. Notch Gasket +0,80 +0,90</p> <p>2. Notch Gasket +0,90 +1,00</p>
<p>ø85,00</p> <p>4 Cyl. Gasoline 1895 cc 87 Kw (118 Ps) M43B 19 E46. 4 Sil. Benzinli 1895 cc 87 Kw (118 Ps) <u>1998 -....</u></p> <p><i>Z3 318i</i></p>	<p>14-5510340 STD -mm 14-5510343 0,50 mm</p>	<p>A = 30,400 B = 53,900 C = 4,000 CD= 70,000</p> <p>Hard Anodising Steel Support</p>	<p>RE15220000 -STD RE15220050 -0,50 RE15220100 -1,00</p> <p>1,200 (500) NitS IF 1,500 (508) P 2,000 (700) Nit S</p>	<p>ø22,0 x 53,8</p>			

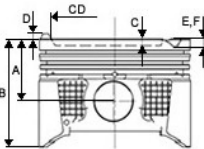







							
Engine	Ref. No. - Kit 1	Dimensions	Rings	Pin	Piston Liner	Kit 2	Info
<p>ø89,00</p> <p>4 Cyl. Gasoline 1990 cc 73,5 Kw (97 Ps) 121 M10. 4 Sil. Benzinli 1990 cc 73.5 Kw (97 Ps) 8 <u>1965 - 1975</u></p> <p><u>BMW 2000</u> 2002 320 520 1965-1975</p>	<p>14-5510380 STD -mm 14-5510383 0,50 mm</p>	<p>A = 42,300 B = 80,300</p> <p>Steel Support</p>	<p>RE15090000 -STD RE15090050 -0,50 RE15090100 -1,00</p> <p>1,750 (500) Cr S IF 2,000 (508) P 4,000 (604) P</p>	<p>ø22,0 x 71,0</p>			
<p>ø92,50</p> <p>8 Cyl. Gasoline 4395cc 210KW/286 PS M62B44LEV <u>1996 -....</u></p> <p>540i 740i 840i X5</p>	<p>18-5510010 STD -mm 18-5510013 0,50 mm</p>	<p>A = 31,300 E = -2,950 F = -53,300</p> <p>Hard Anodising</p>	<p>RE15450000 -STD RE15450050 -0,50 RE15450100 -1,00</p> <p>1,500 (500) Nit S 1,500 (508) P 2,000 (700) Nit S</p>	<p>ø100,0 x 0,0</p>			

							
Engine	Ref. No. - Kit 1	Dimensions	Rings	Pin	Piston Liner	Kit 2	Info
<p>ø68,50</p> <p>4 Cyl. Gasoline cc</p> <p>Kalos 1.2 8v</p> <p>.....-.....</p> <p>KALOS 1.2 8v</p>	<p>18-1010110 STD -mm</p> <p>18-1010113 0,50 mm</p>	<p>A = 25,950</p> <p>B = 53,000</p> <p>C = 3,500</p> <p>E = -3,600</p> <p>F = -3,900</p>	<p>RJ40065A00 -STD - "</p> <p>RJ40065C00 -0,02 " x 53,5</p> <p>1,200 () SV</p> <p>1,200 ()</p> <p>2,500 ()</p>	<p>ø17,0</p> <p>x 53,5</p>			
<p>ø69,70</p> <p>4 Cyl. Gasoline 1229cc</p> <p>63kw</p> <p>86 PS</p> <p>1T2G1</p> <p>2010-.....</p> <p>Aveo II 1.2i 16V</p> <p>Corsa D 1.2i 16V</p>	<p>18-1010150 STD -mm</p> <p>18-1010153 0,50 mm</p>	<p>A = 27,720</p> <p>B = 47,720</p> <p>C = 4,300</p> <p>E = -1,100</p> <p>F = -1,570</p> <p>CD= 63,300</p> <p>Oil Cut-Out</p>	<p>RE16010000 -STD</p> <p>RE16010050 -0,50</p> <p>1,200 (300)</p> <p>1,200 (300)</p> <p>2,000 (300)</p>	<p>ø17,0</p> <p>x 53,5</p>			

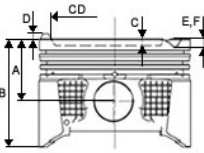

							
Engine	Ref. No. - Kit 1	Dimensions	Rings	Pin	Piston Liner	Kit 2	Info
<p>ø73,40</p> <p>4 Cyl. Gasoline 1229cc 63 kw/ 86 PS A12XER Euro 5 <u>2010 -</u> Aveo II 1.2i 16V Corsa D 1.2i 16V</p>	<p>18-1010140 STD -mm 18-1010143 0,50 mm</p>	<p>A = 26,900 B = 47,900 D = 0,650 E = -1,350 F = -3,950 CD= 54,600</p> <p>Hard Anodising</p>	<p>RE43390000 -STD RE43390050 -0,50</p> <p>1,200 (500) NitBS 1,200 (508) P 2,000 (700) CrPS</p>	<p>ø18,0 x 53,0</p>			
<p>ø77,90</p> <p>R 4 Petrol 1399 cm³ 55 kW (75 hp) 8 6:8 4NB 5HB F14D</p> <p>Aveo 1,4 Kalos 1,4 Lacetti 1,4 2002></p>	<p>18-1010210 STD -mm 18-1010213 0,50 mm</p>	<p>A = 31,900 B = 51,900 C = 1,400 E = -1,400 F = -0,700 CD= 43,000</p>	<p>RE16000000 -STD RE16000050 -0,50</p> <p>1,200 (500) CrB S IF 1,500 (508) P 2,500 (700) Cr P S</p>	<p>ø18,0 x 55,0</p>			











							
Engine	Ref. No. - Kit 1	Dimensions	Rings	Pin	Piston Liner	Kit 2	Info
<p>ø79,00</p> <p>R 4 Petrol 1598 cm³ 55 kW (75 hp) 8 6:2 F16D</p> <p>Aveo Optra Lacetti</p>	<p>18-1010260 STD -mm 18-1010263 0,50 mm</p>	<p>A = 27,800 B = 49,800 C = 2,600 E = -1,600 F = -1,200 CD= 63,850</p>	<p>RE43090000 -STD RE43090025 -0,25 RE43090050 -0,50 RE43090100 -1,00</p> <p>1,200 (500) CrB S 1,500 (508) P 3,000 (700) Cr P S</p>	<p>ø18,0 x 55,0</p>			
<p>ø79,00</p> <p>R 4 Petrol 1598 cm³ CRUZE RP 00 011 J 300 1.6L 16V</p> <p>CRUZE RP 00-011 J300 1.6L 16V 2010-...</p>	<p>18-1010270 STD -mm 18-1010273 0,50 mm</p>	<p>A = 27,100 B = 44,700 E = -2,600 F = -2,600</p> <p>Hard Anodising</p>	<p>RE43490000 -STD RE43490050 -0,50 RE43490100 -1,00</p> <p>1,200 (500) NitB S 1,200 (501) P 2,000 (700) Cr P S</p>	<p>ø19,0 x 50,0</p>			

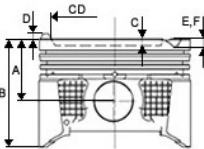









Engine	Ref. No. - Kit 1	Dimensions	Rings	Pin	Piston Liner	Kit 2	Info
<p>ø80,50</p> <p>R 4 Petrol, 1796 cm³ 85 kW (115 hp) Z18XER <u>2000 -.....</u></p> <p>Astra H 1.8i 16V Zafira B 1.8i 16V Vectra C 1.8i 16V Signum 1.8i 16V</p>	<p>18-3010830 STD -mm 18-3010833 0,50 mm 18-3010838 1,00 mm</p>	<p>A = 26,100 B = 45,100 D = 0,700</p> <p>Hard Anodising</p>	<p>RE43370000 -STD RE43370050 -0,50 RE43370100 -1,00</p> <p>1,200 (500) NitB S IF 1,200 (508) P 2,000 (700) Nit S</p>	<p>ø19,0 x 50,0</p>			
<p>ø83,00</p> <p>4 Cyl. Diesel 1991cc 110 Kw(150 BG) Z20S Z20DMH <u>2006 -.....</u></p> <p>CAPTIVA 2.0 16V D ANTARA 2.0 CDTI 16V</p>	<p>18-1092500 STD -mm 18-1092503 0,50 mm</p>	<p>A = 46,350 B = 72,350 C = 13,950 CD= 46,700</p> <p>Ring Carrier Oil Gallery</p>	<p>RE43460000 -STD RE43460000_NPR -STD RE43460050 -0,50</p> <p>2,000 (505) Nit S 2,000 (501) P 3,000 (604) Nit S</p>	<p>ø28,0 x 66,8</p>			<p>1 Notch 0.11 0.23</p> <p>2 Notch 0.24 0.33</p> <p>3 Notch 0.34 0.42</p>

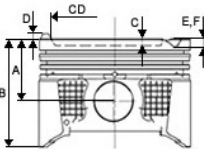





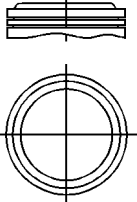

Engine	Ref. No. - Kit 1	Dimensions	Rings	Pin	Piston Liner	Kit 2	Info
<p>ø84,00</p> <p>4 Cyl. Diesel 1995 cc 74 Kw (101 Ps) 18,5:1 Turbo, Intercooler 24 v Y20DTH</p> <p><u>08/2002 -</u></p> <p>ASTRA 2.0 DTI GLS ASTRA 2.0 DTI ASTRA-G 2.0 DI ASTRAVAN IV 2.0 DTI SIGNUM 2.0 DTI VECTRA I/II 2.0 DTI ZAFIRA I 2.0 DTI</p>	<p>14-3092990 STD -mm 14-3092993 0,50 mm</p>	<p>A = 45,800 B = 70,800 C = 14,900 E = -1,000 CD= 41,000</p>	<p>RE43350000 -STD RE43350050 -0,50 RE43350100 -1,00</p> <p>1,750 (500) Cr P 1,750 (501) P 3,000 (604) Cr P</p>	<p>ø29,0 x 62,0</p>			
<p>ø84,80</p> <p>R 4 Gasoline, 1796 cm³ 60 74 kW (82 101 PS) 18S Z18XER</p> <p><u>1986-1988</u></p> <p>Astra Corca Kadett Vectra</p>	<p>14-3010490 STD -mm 14-3010493 0,50 mm</p>	<p>A = 33,650 B = 53,650 C = 5,000 CD= 52,000</p>	<p>RE43160000 -STD RE43160050 -0,50 RE43160100 -1,00</p> <p>1,500 (500) CrB S IF 1,500 (508) P 3,000 (700) Cr S P</p>	<p>ø21,0 x 61,5</p>			

							
Engine	Ref. No. - Kit 1	Dimensions	Rings	Pin	Piston Liner	Kit 2	Info
<p>ø86,00</p> <p>R 4 Gasoline, 1998 cm³ 85 95 kW 20NE C20NE <u>1986-1998</u></p> <p><i>Omega Kadett Ascona Vectra Le Mans 2,0 Espero 2,0 Frontera</i></p>	<p>18-3010630 STD -mm 18-3010633 0,50 mm 18-3010638 1,00 mm</p>	<p>A = 30,400 B = 55,400 C = 5,000 CD= 57,000</p> <p>Steel Support</p>	<p>RE43190000 -STD RE43190050 -0,50 RE43190100 -1,00</p> <p>1,500 (500) CrB S 1,500 (501) P 3,000 (700) Cr P S</p>	<p>ø21,0 x 61,5</p>			
<p>ø86,00</p> <p>2.0i 2.2i X22XE X22SE <u>1998-2000</u></p> <p><i>Omega Kadett Ascona Vectra Leganza Frontera</i></p>	<p>18-3010730 STD -mm 18-3010733 0,50 mm</p>	<p>A = 30,400 B = 55,400 C = 6,500 CD= 63,180</p>	<p>RE43190000 -STD RE43190050 -0,50 RE43190100 -1,00</p> <p>1,500 (500) CrB S 1,500 (501) P 3,000 (700) Cr P S</p>	<p>ø21,0 x 61,5</p>			

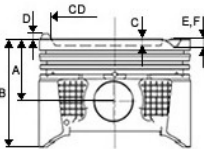







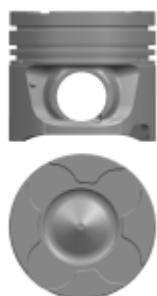
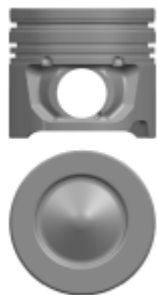

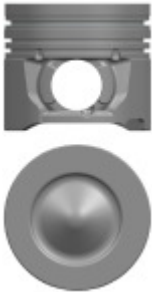

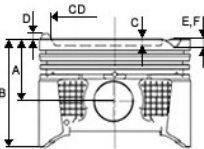
							
Engine	Ref. No. - Kit 1	Dimensions	Rings	Pin	Piston Liner	Kit 2	Info
<p>ø70,00</p> <p>4 Cyl. Gasoline 954 cc 31/33/37 42/45/50 ps TU9M/Z <u>1992 -</u> 205 1.0i 106 1.0i</p>	<p>14-7510510 STD -mm</p>	<p>A = 33,900 B = 58,000 D = 0,800</p>	<p>RE47360000 -STD RE47360050 -0,50</p> <p>1,500 (500) CrBSIF 1,500 (501) P 3,000 (700) CrPS</p>	<p>ø18,0 x 53,0</p>			
<p>ø72,00</p> <p>R 4 Petrol, 1124 cm³ 37 kW (50 hp), 9,7:1 XW7 <u>1981 - 1986</u> 104 205</p>	<p>14-7510070 STD -mm</p> 	<p>A = 40,050 B = 73,700 D = 4,200</p>	<p>RE18020000 -STD</p> <p>1,500 (500) Cr S 2,000 (501) P 4,000 (700) Cr P S</p>	<p>ø19,5 x 62,0</p>			

Engine	Ref. No. - Kit 1	Dimensions	Rings	Pin	Piston Liner	Kit 2	Info
<p>ø72,00</p> <p>R 4 Petrol, 1124 cm³ 40 kW (54 hp) TU1 E1 A TU1K TU 1M XW3 XW3S XW7/A</p> <p><u>1988-1992</u></p> <p>106 205 306 309 Partner</p>	<p>14-7510130 STD -mm</p>	<p>A = 40,000 B = 67,000 D = 3,000</p>	<p>RE18020000 -STD</p> <p>1,500 (500) Cr S 2,000 (501) P 4,000 (700) Cr P S</p>	<p>ø19,5 x 62,0</p>			
<p>ø73,70</p> <p>4 Cyl. Diesel 1399 cc 50 Kw (68 Ps) DV4TD DV4 TED DV4C TED F6JA F6JB 8HX 8HR 8HZ 8HS</p> <p><u>2002 -....</u></p> <p>Fiesta V 1.4 TDCI Fusion 1.4 TDCI Mazda 2 1,4D C2 1.4 HDI C3 1.4 HDI XSARA 1.4 HDI NEMO 1.4 HDI 1007 1.4 HDI 107 1.4 HDI 206 1.4 HDI 207 1.4 HDI 307 1.4 HDI BIPPER 1.4 HDI</p>	<p>18-2550150 STD -mm 18-2550150-20 STD -mm (0.2 mm SHORT) 18-2550150-40 STD -mm (0.4 mm SHORT)</p> <p>18-2550153 0,50 mm 18-2550153-20 0,50 mm (0.2 mm SHORT) 18-2550153-40 0,50 mm (0.4 mm SHORT)</p>	<p>A = 42,940 B = 65,440 C = 14,700 CD= 37,200</p> <p>Ring Carrier</p>	<p>RE23050000 -STD RE23050050 -0,50</p> <p>2,500 (505) CrB P 1,950 (508) P IFU 2,500 (604) Cr P</p>	<p>ø25,0 x 60,0</p>			

							
Engine	Ref. No. - Kit 1	Dimensions	Rings	Pin	Piston Liner	Kit 2	Info
<p>ø73,70</p> <p>4 Cyl. Diesel 1398cc 68 HP 50 KW DV4C Euro 5 <u>2010 -</u> <i>Fiesta V 1.4 TDCI</i></p>	<p>18-2550160 STD -mm 18-2550163 0,50 mm</p>	<p>A = 42,900 B = 65,400 C = 12,500 CD= 45,100</p> <p>Ring Carrier Oil Cut-Out</p>	<p>RE23580000 -STD RE23580050 -0,50</p> <p>2,500 (514) Cr P 1,950 (508) P IFU 2,000 (604) Nit S</p>	<p>ø25,0 x 60,0</p>			
<p>ø73,70</p> <p>R 4 Diesel, 1398 cm³ 50/66kW (68PS/90PS) 17,5:1,16 Ventile,T 8HY (DV4TED4) 8HS (DV4TED), Euro 4 <u>02/2002...04/2005</u> <i>C3 I 1.4 HDI Peugeot Turbo</i></p>	<p>18-7592160 STD -mm 18-7592161 0,25 mm 18-7592163 0,50 mm</p>	<p>A = 42,940 B = 65,440 C = 14,390 E = -1,180 CD= 37,160</p> <p>Ring Carrier Oil Gallery Oil Cut-Out</p>	<p>RE23050000 -STD RE23050050 -0,50</p> <p>2,500 (505) CrB P 1,950 (508) P IFU 2,500 (604) Cr P</p>	<p>ø24,9 x 60,0</p>			

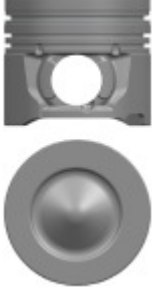
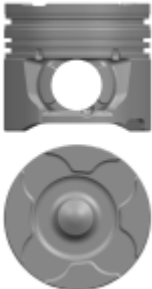



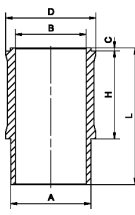



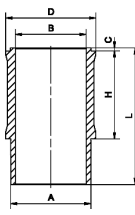
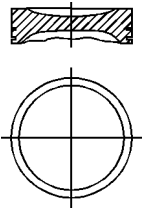

							
Engine	Ref. No. - Kit 1	Dimensions	Rings	Pin	Piston Liner	Kit 2	Info
<p>ø75,00</p> <p>4 Cyl. Diesel 1560cc 70 Kw (95 Ps) 1.6 HDi (DV6C) EUR5 1.6 HDi (DV6D) Euro 4 <u>2011 -</u></p> <p><i>FOCUS BERLINGO 1.6 8V C4 (B7) DS4 (9HR-9HL) DS5 Grand Picasso II C4 DS4 DS3 C3 C3 II 3008 308 5008 508 Partner Tepee 2008 308 SW 207 SW 208 207</i></p> 	<p>18-2581660 STD -mm <i>18-2581660-20 STD -mm (0.2 mm SHORT)</i> 18-2581660-40 STD -mm <i>(0.4 mm SHORT)</i> 18-2581663 0,50 mm <i>18-2581663-20 0,50 mm (0.2 mm SHORT)</i> <i>18-2581663-40 0,50 mm (0.4 mm SHORT)</i></p>	<p>A = 41,750 B = 65,200 C = 13,850 CD= 45,000</p> <p>Ring Carrier Oil Gallery Oil Cut-Out</p>	<p>RE23550000 -STD RE23550050 -0,50</p> <p>2,500 (514) Cr P 1,950 (508) P 2,000 (604) Nit S</p>	<p>ø26,0 x 61,0</p>			<p>1 Notch 0,5 mm 0,63 mm</p> <p>2 Notch 0,63 mm 0,68 mm</p> <p>3 Notch 0,68 mm 0,73 mm</p> <p>4 Notch 0,73 mm 0,78 mm</p> <p>5 Notch 0,78 mm 0,88 mm</p>
<p>ø75,00</p> <p>4 Cyl. Diesel 1560 cc 80 Kw (109 Ps) DV6TD/TED <u>2004 -....</u></p> <p><i>Expert 1,6 HDI 307 1,6 HDI 206 1,6 HDI C4 1,6 HDI Jumpy 1,6 HDI C-Max 1,6 HDI Focus 1,6 HDI</i></p> 	<p>18-2591770 STD -mm <i>18-2591770-20 STD -mm (0.2 mm SHORT)</i> 18-2591770-40 STD -mm <i>(0.4 mm SHORT)</i> 18-2591773 0,50 mm <i>18-2591773-20 0,50 mm (0.2 mm SHORT)</i> <i>18-2591773-40 0,50 mm (0.4 mm SHORT)</i> 18-2591774 0,60 mm <i>18-2591774-20 0,60 mm (0.2 mm SHORT)</i> <i>18-2591774-40 0,60 mm (0.4 mm SHORT)</i></p>	<p>A = 41,700 B = 65,300 C = 13,250 E = -1,200 CD= 41,800</p> <p>Ring Carrier Oil Gallery Oil Cut-Out</p>	<p>RE47460000 -STD RE47460040 -0,40 RE47460050 -0,50 RE47460060 -0,60</p> <p>3,000 (505) CKP 1,950 (508) P 2,500 (604) CrP</p>	<p>ø26,0 x 61,0</p>			<p>1.35 mm Gasket +0,68 +0,73</p> <p>1.25 mm Gasket +0,53 +0,63</p> <p>1.30 mm Gasket +0,63 +0,68</p> <p>1.40 mm Gasket +0,73 +0,78</p> <p>1.45 mm Gasket +0,78 +0,88</p>

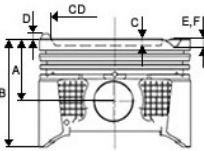





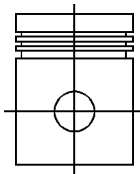

Engine	Ref. No. - Kit 1	Dimensions	Rings	Pin	Piston Liner	Kit 2	Info
<p>ø75,00</p> <p>R 4 Petrol, 1361 cm³ 55 kW (75 hp), 10,5:1 Düz Tepe TU3JPL4 KFW(TU3JP) KFX(TU3JP)</p> <p><u>2004 -....</u></p> <p><i>Berlingo 1.4 l</i> <i>Saxo 1.4 l</i> <i>Xsara 1.4 l</i> <i>106 II 1.4 l</i> <i>205 II 1.4 l</i> <i>206 1.4 l</i> <i>306 1.4 l</i> <i>307 1.4 l</i> <i>Partner 1.4 l</i></p> 	<p>18-7510060 STD -mm 18-7510063 0,50 mm</p>	<p>A = 27,750 B = 49,930 D = 0,180</p>	<p>RE47580000 -STD RE47580050 -0,50</p> <p>1,500 (500) CrB Fe S IF 1,500 (501) P 2,500 (700) Cr P S</p>	<p>ø18,0 x 55,0</p>	<p>G79501350S_1</p> <p>A= 79,500 B= 75,000 D= 89,200 F= 0,000 H= 90,000 L= 135,000</p> 		
<p>ø75,00</p> <p>4. Cyl. Gasoline 1361cc 54/55 kW 73/75 ps TU3JP</p> <p><u>2005 -....</u></p> <p><i>PARTNER 1.4i</i> <i>1007 1.4i</i> <i>307 1.4i</i> <i>306 1.4i</i> <i>206 1.4i</i> <i>RANCH 1.4i</i> <i>106 1.4i</i></p>	<p>18-7510090 STD -mm</p>	<p>A = 27,900 B = 49,700 C = 1,250 CD= 64,750</p>	<p>RE47580000 -STD RE47580050 -0,50</p> <p>1,500 (500) CrB Fe S IF 1,500 (501) P 2,500 (700) Cr P S</p>	<p>ø18,0 x 55,0</p>			

Engine	Ref. No. - Kit 1	Dimensions	Rings	Pin	Piston Liner	Kit 2	Info
<p>ø75,00</p> <p>R 4 Petrol, 1218 cm³ 42 kW (57 hp) XZ5 XY6B XY7 XYB XYR <u>1978 - 1984</u></p>	<p>14-7510100 STD -mm</p>	<p>A = 28,250 B = 52,330 D = 1,300 E = -3,100</p>	<p>RE47000000 -STD RE47000050 -0,50</p> <p>1,750 (500) CrBSIF 2,000 (508) P 3,000 (700) CrPS</p>	<p>ø19,5 x 62,0</p>			
<p>ø75,00</p> <p>R 4 Petrol, 1361 cm³ 65 kW (88 hp) KFU(ET 3 J4) <u>2003 -....</u> C 2 1.4 I C 3 1.4 I C 4 1.4 I 1007 1.4 I 206 1.4 207 1.4 307 1.4</p>	<p>18-7510110 STD -mm 18-7510113 0,50 mm</p>	<p>A = 28,250 B = 52,330 D = 1,300 E = -3,180</p>	<p>RE47590000 -STD RE47590050 -0,50</p> <p>1,200 (500) Cr P 1,500 (508) P 2,500 (604) P</p>	<p>ø18,0 x 44,5</p>	<p>G79501350S_1</p> <p>A= 79,500 B= 75,000 D= 89,200 F= 0,000 H= 90,000 L= 135,000</p>		

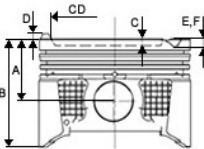
Engine	Ref. No. - Kit 1	Dimensions	Rings	Pin	Piston Liner	Kit 2	Info
<p>ø75,00</p> <p>R 4 Petrol, 1361 cm³ 55 kW (75 hp), 10,5:1 TU3JPL4 KFW(TU3JP) KFX(TU3JP) <u>2004 -....</u></p> <p><i>Berlingo 1.4 l</i> <i>Saxo 1.4 l</i> <i>Xsara 1.4 l</i> <i>106 II 1.4 l</i> <i>205 II 1.4 l</i> <i>206 1.4 l</i> <i>306 1.4 l</i> <i>307 1.4 l</i> <i>Partner 1.4 l</i></p> 	<p>18-7510120 STD -mm 18-7510123 0,50 mm</p>	<p>A = 27,750 B = 49,930 D = 0,180</p>	<p>RE47580000 -STD RE47580050 -0,50</p> <p>1,500 (500) CrB Fe S IF 1,500 (501) P 2,500 (700) Cr P S</p>	<p>ø18,0 x 55,0</p>	<p>G79501350S_1</p> <p>A= 79,500 B= 75,000 D= 89,200 F= 0,000 H= 90,000 L= 135,000</p> 		
<p>ø75,00</p> <p>R 4 Petrol, 1361 cm³ 44 55 kW (60 75 hp) 9,3:1 TU3A <u>1987-1992</u></p> <p><i>106</i> <i>205</i> <i>206</i> <i>306</i> <i>309</i> <i>Partner</i></p> 	<p>14-7510270 STD -mm 14-7510273 0,50 mm</p>	<p>A = 40,500 B = 64,500 C = 1,100 CD= 63,000</p>	<p>RE47000000 -STD RE47000050 -0,50</p> <p>1,750 (500) CrBSIF 2,000 (508) P 3,000 (700) CrPS</p>	<p>ø19,5 x 62,0</p>			

							
Engine	Ref. No. - Kit 1	Dimensions	Rings	Pin	Piston Liner	Kit 2	Info
<p>ø77,00</p> <p>4 Cyl. Gasoline 13970 cc 70 kW 95 PS EP3</p> <p>.....-.....</p> <p>207 WA/WC 1.4 16V 207 SW (WK) 1.4 16V 308 4A/4C 1.4 16V</p>	<p>18-7510280 STD -mm 18-7510283 0,50 mm</p>	<p>A = 27,600 B = 47,500 D = 3,100</p>	<p>RE15260000 -STD ø18,0 RE15260000_NPR -STD ø13,0 RE15260050 -0,50 RE15260050_NPR -0,50</p> <p>1,200 (500) Cr S IF 1,500 (508) P 2,000 (700) Cr P S</p>				
<p>ø78,00</p> <p>R 4 Petrol, 1290 cm³ 44 48 kW (60 65 hp) XL5</p> <p>1976-1988</p> <p>305 SR</p>	<p>14-7510140 STD -mm 14-7510143 0,50 mm</p>	<p>A = 36,100 B = 72,300</p>	<p>RE47400000 -STD ø20,5 RE47400050 -0,50 x 68,0</p> <p>1,750 (500) CrB S IF 2,000 (501) P 4,000 (604) P</p>				



							
Engine	Ref. No. - Kit 1	Dimensions	Rings	Pin	Piston Liner	Kit 2	Info
<p>ø78,00</p> <p>R 4 Petrol, 1472 cm³ 49 58 kW (67 79 hp) XR5 <u>1977 -....</u> 305 SR</p>	<p>14-7510150 STD -mm 14-7510153 0,50 mm</p>	<p>A = 36,100 B = 73,100 D = 0,400</p>	<p>RE47400000 -STD RE47400050 -0,50</p> <p>1,750 (500) CrB S IF 2,000 (501) P 4,000 (604) P</p>	<p>ø20,5 x 68,0</p>			
<p>ø78,50</p> <p>4 Cyl. Gasoline 1587 cc 80 Kw (109 Ps) TU5JP4 Euro3 <u>2000 -....</u> C3 1.6i 16V Berlingo 1.6i 16v 206 1.6i 16v 307 1.6i 16v Partner 1.6i 16v</p>	<p>18-7510700 STD -mm 18-7510703 0,50 mm</p>	<p>A = 32,350 B = 50,150 D = 0,150</p> <p>Oil Cut-Out</p>	<p>RE47380000 -STD RE47380025 -0,25 RE47380040 -0,40 RE47380050 -0,50 RE47380100 -1,00</p> <p>1,200 (500) MoB N S 1,500 (508) P 2,500 (604) P</p>	<p>ø19,6 x 57,0</p>			

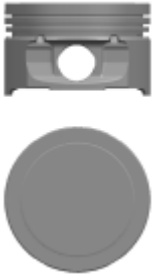
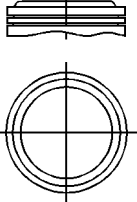

Engine	Ref. No. - Kit 1	Dimensions	Rings	Pin	Piston Liner	Kit 2	Info
<p>ø78,50</p> <p>4 Cyl. Gasoline 1587 cc 80 Kw (118 Ps) 10,8:1 16 Ventile NFX (TU5J4) <u>05/1996 -....</u></p> <p>106 GTI 106 II 1.6 206 306 307</p>	<p>18-7510710 STD -mm 18-7510711 0,25 mm 18-7510713 0,50 mm</p>	<p>A = 32,500 B = 57,800 C = 1,200</p>	<p>RE47280000 -STD RE47280025 -0,25 RE47280050 -0,50</p> <p>1,500 (500) Cr P S IF 1,500 (508) P 3,000 (700) Cr P S</p>	<p>ø19,5 x 59,0</p>			
<p>ø78,50</p> <p>4 Cyl. Gasoline 85 kw 115 HP EC5 1.6 VTI EURO 5 <u>2012 -</u></p> <p>301 C-ELYSEE</p>	<p>18-7510820 STD -mm 18-7510823 0,50 mm</p>	<p>A = 32,350 B = 53,750 D = 1,400 E = -2,450</p>	<p>RE47650000 -STD RE47650050 -0,50</p> <p>1,000 (500) Nit S IF 1,200 (508) P 2,000 (604) Nit S</p>	<p>ø19,6 x 57,0</p>			



Engine	Ref. No. - Kit 1	Dimensions	Rings	Pin	Piston Liner	Kit 2	Info
<p>ø78,50</p> <p>R 4 Petrol, 1587 cm³ 65 kW (88 hp) TU5JP <u>1996 - 1998</u></p> <p><i>C3 1.6i 16V</i> <i>Berlingo 1.6i 16v</i> <i>206 1.6i 16v</i> <i>207 1.6i 16v</i> <i>307 1.6i 16v</i> <i>Partner 1.6i 16v</i></p> 	<p>18-7510880 STD -mm 18-7510882 0,40 mm 18-7510883 0,50 mm</p>	<p>A = 32,250 B = 57,500 C = 1,500 CD= 68,500</p>	<p>RE47280000 -STD RE47280025 -0,25 RE47280050 -0,50</p> <p>1,500 (500) Cr P S IF 1,500 (508) P 3,000 (700) Cr P S</p>	<p>ø19,5 x 61,9</p>			
<p>ø80,00</p> <p>4 Cyl. Diesel 1768 cc 22:1 Turbo XUD7T TE TEY <u>1995 -....</u></p> <p><i>205 TD</i> <i>309TD</i> <i>SRD</i> <i>GRD</i> <i>SXD</i> <i>XSD,405TD</i> <i>SRD</i> <i>GRD</i> <i>GTD</i></p>	<p>18-7550430 STD -mm 18-7550433 0,50 mm 18-7550437 0,80 mm</p>	<p>A = 46,800 B = 84,500 C = 2,200</p> <p>Ring Carrier Hard Anodising Oil Cut-Out</p>	<p>RE47050000 -STD RE47050050 -0,50 RE47050080 -0,80</p> <p>3,000 (504) Cr 2,000 (501) P 3,000 (604) Cr P</p>	<p>ø28,0 x 68,0</p>			<p>1. Tamir + 0,54 + 0,65</p> <p>2. Tamir + 0,65 + 0,77</p> <p>3. Tamir + 0,77 + 0,82</p>



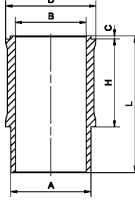
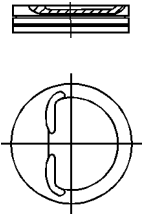



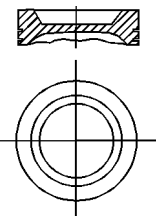
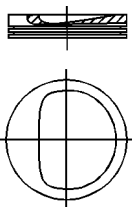

Engine	Ref. No. - Kit 1	Dimensions	Rings	Pin	Piston Liner	Kit 2	Info
<p>ø80,00</p> <p>R 4 Diesel, 1769 cm³ 44 kW (60 PS) 23:1 8 Ventile XUD7</p> <p><u>1985 - 1993</u></p> <p>205 I 1.7 D 205 II 1.7 D 305 II 1.8 D 306 1.8 D BIPPER 1.8 D</p>	<p>18-7550440 STD -mm 18-7550443 0,50 mm 18-7550447 0,80 mm</p>	<p>A = 46,800 B = 84,500 C = 2,000</p>	<p>RE47060000 -STD RE47060050 -0,50 RE47060080 -0,80 RE47060100 -1,00</p> <p>2,000 (500) CrB S 2,000 (501) P 3,000 (604) Cr P</p>	<p>ø25,0 x 69,8</p>			
<p>ø82,20</p> <p>4 Cyl. Diesel 1868 cc 51 Kw (71 Ps) 23:1 DW8</p> <p><u>1998 -.....</u></p> <p>206 1.9 D 306 1.9 D Expert 1.9 D Partner 1.9 D</p>	<p>18-7550460 STD -mm 18-7550460-20 STD -mm (0.2 mm SHORT) 18-7550463 0,50 mm 18-7550463-20 0,50 mm (0.2 mm SHORT) 18-7550464 0,60 mm 18-7550464-20 0,60 mm (0.2 mm SHORT) 18-7550467 0,80 mm 18-7550468 1,00 mm</p>	<p>A = 46,730 B = 78,000 C = 1,300</p> <p>Oil Cut-Out</p>	<p>RE47430000 -STD RE47430050 -0,50 RE47430060 -0,60 RE47430080 -0,80 RE47430100 -1,00</p> <p>2,000 (500) CrBS 2,000 (508) P 3,000 (604) Cr</p>	<p>ø25,0 x 66,0</p>			<p>1.26 mm Gasket + 0,51 + 0,55</p> <p>1.30 mm Gasket + 0,55 + 0,59</p> <p>1.34 mm Gasket + 0,59 + 0,63</p>

Engine	Ref. No. - Kit 1	Dimensions	Rings	Pin	Piston Liner	Kit 2	Info
<p>ø83,00</p> <p>4 Cyl. Gasoline 1580 cc 9,5:1 XU5 S 2C 1C CP</p> <p><u>1982 - 1990</u></p> <p>205 Automatic Open XR XS XT 305GL</p> 	<p>18-7510180 STD -mm 18-7510183 0,50 mm</p>	<p>A = 37,500 B = 67,500 C = 2,100</p>	<p>RE47080000 -STD RE47080050 -0,50 RE47080080 -0,80</p> <p>1,750 (500) CrB S IF 1,750 (508) P 4,000 (700) Cr P S</p>	<p>ø22,0 x 66,0</p>	<p>G88001410S_1</p> <p>A= 79,500 B= 75,000 D= 89,200 F= 0,000 H= 90,000 L= 135,000</p> 		
<p>ø83,00</p> <p>R 4 Petrol, 1580 cm³ 59 66 kW (80 90 hp) XU52C CR</p> <p><u>1982 - 1990</u></p> <p>309 405 1983></p> 	<p>14-7510190 STD -mm</p>	<p>A = 37,500 B = 67,500 C = 2,900</p>	<p>RE47080000 -STD RE47080050 -0,50 RE47080080 -0,80</p> <p>1,750 (500) CrB S IF 1,750 (508) P 4,000 (700) Cr P S</p>	<p>ø22,0 x 66,2</p>			

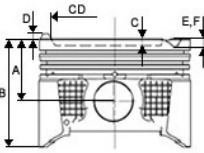





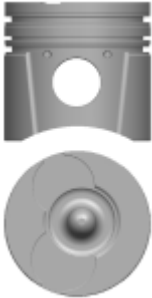
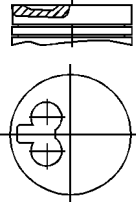

Engine	Ref. No. - Kit 1	Dimensions	Rings	Pin	Piston Liner	Kit 2	Info
<p>ø83,00</p> <p>R 4 Petrol, 1905 cm³ 73 95 kW (99 129 hp) XU9JA <u>1985 - 1993</u> 205 1,9 GTI 309 1,9</p>	<p>14-7510360 STD -mm 14-7510363 0,50 mm</p>	<p>A = 37,500 B = 67,500 C = 9,000</p>	<p>RE47090000 -STD RE47090050 -0,50</p> <p>1,500 (500) CrB S IF 1,500 (501) P 4,000 (700) Cr S</p>	<p>ø22,0 x 66,2</p>			
<p>ø83,00</p> <p>R 4 Petrol, 1581 cm³ 53 59 kW (72 80 hp) XU51C XU92C <u>1982 - 1990</u> 309 405</p>	<p>14-7510380 STD -mm 14-7510383 0,50 mm</p>	<p>A = 37,500 B = 67,500 C = 3,000 CD= 73,800</p>	<p>RE47080000 -STD RE47080050 -0,50 RE47080080 -0,80</p> <p>1,750 (500) CrB S IF 1,750 (508) P 4,000 (700) Cr P S</p>	<p>ø22,0 x 66,2</p>			

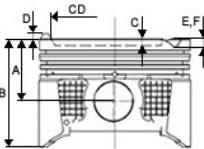

Engine	Ref. No. - Kit 1	Dimensions	Rings	Pin	Piston Liner	Kit 2	Info
<p>ø83,00</p> <p>4 Cyl. Gasoline 1762 cc 74 76 KW101 103PS 9,25;1 XU7JPZ</p> <p><u>1992 - 2002</u></p> <p>306 1,8i 405 1,8i 806 1,8i</p>	<p>18-7510400 STD -mm 18-7510403 0,50 mm</p>	<p>A = 33,300 B = 53,300 C = 4,200 CD= 67,700</p> <p>Steel Support</p>	<p>RE47100000 -STD RE47100050 -0,50 RE47100080 -0,80</p> <p>1,500 (500) CrB Fe S IF 1,500 (501) P 3,000 (700) Cr P S</p>	<p>ø22,0 x 62,0</p>	<p>G88001410S_1</p> <p>A= 79,500 B= 75,000 D= 89,200 F= 0,000 H= 90,000 L= 135,000</p>		
<p>ø83,00</p> <p>R 4 Diesel, 1905 cm³ 55 69 kW (75 94 PS) XUD9/A</p> <p><u>1995 -</u></p> <p>205 // 1.9D 306 1.9D 309 // 1.9D 405 // 1.9D Boxer 1.9D Partner 1.9D</p>	<p>18-7550450 STD -mm 18-7550453 0,50 mm 18-7550458 1,00 mm</p>	<p>A = 46,800 B = 84,300 C = 2,200</p>	<p>RE47070000 -STD RE47070050 -0,50 RE47070060 -0,60 RE47070080 -0,80 RE47070100 -1,00</p> <p>2,000 (500) CrB S 2,000 (501) P 3,000 (604) Cr P</p>	<p>ø25,0 x 72,0</p>			

							
Engine	Ref. No. - Kit 1	Dimensions	Rings	Pin	Piston Liner	Kit 2	Info
<p>ø83,00</p> <p>4 Cyl. Diesel 1905 cc 51 Kw (69 Ps) 23,5:1 XUD9/A/L/Y <u>1996 -....</u></p> <p>205D GLD /GRD/XLD/XRD 305D/GLD/GRD/SRD Utilitaire 306/309D GLD/GRD/GTD/SRD XDT/XRD/X 405GLD/GRD/J5 Boxer Expert Partner</p>	<p>18-7550480 STD -mm 18-7550483 0,50 mm 18-7550488 1,00 mm</p>	<p>A = 46,850 B = 84,250 C = 2,200</p> <p>Ring Carrier</p>	<p>RE47070000 -STD RE47070050 -0,50 RE47070060 -0,60 RE47070080 -0,80 RE47070100 -1,00</p> <p>2,000 (500) CrB S 2,000 (501) P 3,000 (604) Cr P</p>	<p>ø25,0 x 70,4</p>			
<p>ø83,00</p> <p>4 Cyl. Gasoline 1905 cc 9,3:1 8v MPi XU9JA J1 J2 JAZ M <u>1986 - 1998</u></p> <p>19 Evasion XU9J1(D6A) XUPJ2 (DFZ) 19 RI XU9J1 (D6A) XUPJ2 (DFZ) 19 RI XU9JA (DDZ-DKZ) 19 TRI XU9JA (DDZ-DKZ) 19GTI XU9J1 (D6A) XUPJ2 (DFZ) 19GTI XU9JA (DDZ-DKZ) 19TRI XU9J1 (D6A) XUPJ2 (DFZ) BX 19 4W</p>	<p>14-7550490 STD -mm</p>	<p>A = 37,500 B = 67,500 C = 8,900</p> <p>Steel Support</p>	<p>RE47090000 -STD RE47090050 -0,50</p> <p>1,500 (500) CrB S IF 1,500 (501) P 4,000 (700) Cr S</p>	<p>ø22,0 x 66,2</p>			

Engine	Ref. No. - Kit 1	Dimensions	Rings	Pin	Piston Liner	Kit 2	Info
<p>ø85,00</p> <p>4 Cyl. Diesel 1997/1998 cc 79/80/81/100Kw 90/107/109Ps 110/136 Ps DW10ATED TD10ATED DW10TD Euro 3 G6DB RHS RHW RHX RHY RHZ D420 4T</p> <p><u>1998 -</u></p> <p>2.0 HDI 206/306/307/406 Boxer Partner Expet C5 Jumpy Xsara Scudo 2.0JTD Cmax Focus II Grand Vitara C30 C70 S40/80 II V50 V70 III TDI</p>	<p>18-7550900 STD -mm 18-7550900-20 STD -mm (0.2 mm SHORT) 18-7550903 0,50 mm 18-7550904 0,60 mm</p> 	<p>A = 46,750 B = 80,750 C = 18,300 E = -1,000 CD= 38,000</p> <p>Ring Carrier Oil Cut-Out</p>	<p>RE47440000 -STD RE47440060 -0,60</p> <p>3,500 (505) Cr P 2,000 (501) P IFU 3,000 (604) Cr P</p>	<p>ø28,0 x 70,0</p>			<p>1,25 mm Gasket +0,55 + 0,60</p> <p>1,30 mm Gasket +0,61 +0,65</p> <p>1,35 mm Gasket +0,66 +0,70</p> <p>1,40 mm Gasket +0,71 +0,75</p>
<p>ø83,00</p> <p>R 4 Diesel, 1905 cm³ 55 69 kW (75 94 PS) XUD9ATF XUD9BSD XUD9BTF</p> <p><u>1993 - 2004</u></p> <p>306 1.9 TD 405 1.9 TD 406 1.9 TD 806 1.9 TD Boxer 1.9 TD Ducato 1.9 TD</p>	<p>18-7550910 STD -mm 18-7550913 0,50 mm 18-7550917 0,80 mm</p> 	<p>A = 46,750 B = 79,250 C = 3,500</p> <p>Hard Anodising</p>	<p>RE22250000 -STD RE22250050 -0,50 RE22250080 -0,80</p> <p>3,000 (504) Cr P 2,000 (501) P 3,000 (604) Cr P</p>	<p>ø28,0 x 68,0</p>			

							
Engine	Ref. No. - Kit 1	Dimensions	Rings	Pin	Piston Liner	Kit 2	Info
<p>ø83,00</p> <p>R 4 Diesel, 1905 cm³ 55 69 kW (75 94 PS) XUD9ATF XUD9BSD XUD9 BTF <u>1992 - 2004</u></p> <p>306 1.9 TD 405 1.9 TD 406 1.9 TD 806 1.9 TD Boxer 1.9 TD Ducato 1.9 TD</p>	<p>14-7550920 STD -mm 14-7550923 0,50 mm</p>	<p>A = 46,750 B = 79,250 C = 3,500</p> <p>Ring Carrier Hard Anodising Oil Cut-Out</p>	<p>RE47230000 -STD RE47230050 -0,50 RE47230080 -0,80</p> <p>3,500 (504) Cr 2,000 (501) P 3,000 (604) Cr P</p>	<p>ø28,0 x 68,0</p>			
<p>ø85,00</p> <p>R 4 Diesel, 1997 cm³ 62 88 kW (84 120 PS) DW10BTED4 <u>1999 - 2007</u></p> <p>(2.0HDI) Berlingo C4 16V C4 GrandPicasso 16V C4 Picasso 16V C5 16V C8 16V Jumpy 6V C-Max Kuga 307 16V 307 CC 16V 308 16V 407 16V 508</p>	<p>18-7551920 STD -mm 18-7551924 0,60 mm</p>	<p>A = 46,705 B = 80,705 C = 15,400 E = -0,520 CD= 44,800</p> <p>Ring Carrier Oil Gallery Oil Cut-Out</p>	<p>RE47440000 -STD RE47440060 -0,60</p> <p>3,500 (505) Cr P 2,000 (501) P IFU 3,000 (604) Cr P</p>	<p>ø28,0 x 70,0</p>			

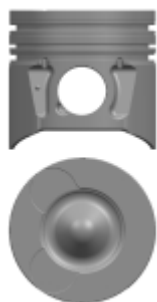

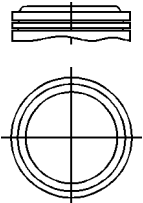
Engine	Ref. No. - Kit 1	Dimensions	Rings	Pin	Piston Liner	Kit 2	Info
<p>ø84,00</p> <p>R 4 Gasoline 1796cc 49 51kW (69 PS) 7,5:1,8 Ventile C25 1.8 169 (XM7T) <u>07/87-02/94</u></p> <p><i>C25 1.8 E C25 1.8 EF/87-2/94 DUCATO 1.8 1/82-10/88 504 1.8 1/71-12/89 505 1.8 6/81-10/85 15 1.8 1/83-11/88 7/70-3/80</i></p>	<p>14-7510020 STD -mm</p>	<p>A = 37,800 B = 70,250</p>	<p>RE22280000 -STD</p> <p>1,500 (500) Cr S IF 2,000 (508) P 4,000 (700) Cr P S</p>	<p>ø23,0 x 70,0</p>			
<p>ø84,00</p> <p>R 4 Petrol, 1796 cm³ 48 58 kW (65 79 hp) 7,5:1 XM7 KF5 KF6 <u>1971 - 1981</u></p> <p><i>504 505 J7 J9 1986></i></p>	<p>14-7510030 STD -mm</p> 	<p>A = 37,300 B = 70,300 D = 1,000</p>	<p>RE47120000 -STD</p> <p>1,500 (500) Cr S IF 25,000 (508) P 4,000 (700) Cr P S</p>	<p>ø23,0 x 70,0</p>			





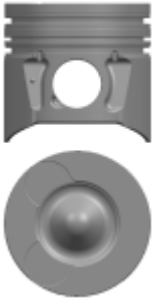
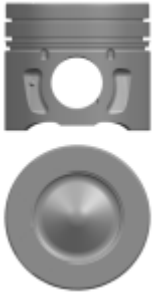

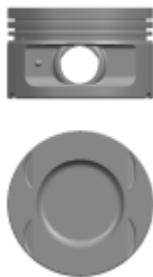

Engine	Ref. No. - Kit 1	Dimensions	Rings	Pin	Piston Liner	Kit 2	Info
<p>ø85,00</p> <p>4 Cyl. Gasoline 2000 cc 100/105 kW 136/1436 PS EW10J B</p> <p>..... -</p> <p>307 206 EXPEERT 407 607 406 806</p>	<p>18-7510750 STD -mm 18-7510752 0,40 mm 18-7510754 0,60 mm</p>	<p>A = 29,000 B = 51,000 C = 0,750 CD= 48,000</p>	<p>RE18500000 -STD RE18500040 -0,40 RE18500050 -0,50 RE18500060 -0,60 RE18500080 -0,80</p> <p>1,200 (500) Nit S IF 1,500 (508) P 2,500 (700) Nit S</p>	<p>ø21,0 x 68,0</p>			
<p>ø85,00</p> <p>4 Cyl. Diesel 2088 cc 81 Kw (110 Ps) 21,5:1 XUD11BTE</p> <p>1995 -.....</p> <p>406 2.1TD 605 2.1TD 806 2.1TD</p>	<p>14-7550880 STD -mm 14-7550884 0,60 mm</p>	<p>A = 44,900 B = 74,700 C = 2,400</p> <p>Ring Carrier Hard Anodising Oil Gallery Oil Cut-Out</p>	<p>RE47240000 -STD RE47240050 -0,50 RE47240060 -0,60</p> <p>3,000 (504) Cr P 2,000 (501) P 3,000 (604) Cr P</p>	<p>ø30,0 x 68,0</p>			<p>1.52 mm Gasket 0,65 0,75</p> <p>1.57 mm Gasket 0,77 0,81</p> <p>1.62 mm Gasket 0,82 0,86</p>

Engine	Ref. No. - Kit 1	Dimensions	Rings	Pin	Piston Liner	Kit 2	Info
<p>ø85,00</p> <p>Turbo Intercooler 3 Valf DW12TD/TED <u>2002 -....</u></p> <p>607 HDI 406 HDI Boxer 330M/330C/290C 2,2 HDI</p>	<p>18-7550890 STD -mm 18-7550894 0,60 mm</p>	<p>A = 48,700 B = 70,700 C = 17,700 E = -1,200 CD= 42,000</p> <p>Ring Carrier Oil Cut-Out</p>	<p>RE47440000 -STD RE47440060 -0,60</p> <p>3,500 (505) Cr P 2,000 (501) P IFU 3,000 (604) Cr P</p>	<p>ø30,0 x 68,0</p>			
<p>ø85,00</p> <p>4 Cyl. Diesel 1997/1998 cc 79/80/81/100Kw 90/107/109Ps 110/136 Ps DW10ATED TD10ATED DW10TD Euro 3 G6DB RHS RHW RHX RHY RHZ D420 4T</p> <p><u>1998 -</u></p> <p>2,0 HDI 206/306/307/406 Boxer Partner Expet C5 Jumpy Xsara Scudo 2.0JTD Cmax Focus II Grand Vitara C30 C70 S40/80 II V50 V70 III TDI</p>	<p>18-7550900 STD -mm 18-7550900-20 STD -mm (0.2 mm SHORT) 18-7550903 0,50 mm 18-7550904 0,60 mm</p>	<p>A = 46,750 B = 80,750 C = 18,300 E = -1,000 CD= 38,000</p> <p>Ring Carrier Oil Cut-Out</p>	<p>RE47440000 -STD RE47440060 -0,60</p> <p>3,500 (505) Cr P 2,000 (501) P IFU 3,000 (604) Cr P</p>	<p>ø28,0 x 70,0</p>			<p>1,25 mm Gasket +0,55 + 0,60</p> <p>1,30 mm Gasket +0,61 +0,65</p> <p>1,35 mm Gasket +0,66 +0,70</p> <p>1,40 mm Gasket +0,71 +0,75</p>

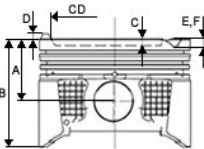
Engine	Ref. No. - Kit 1	Dimensions	Rings	Pin	Piston Liner	Kit 2	Info
<p>ø85,00</p> <p>R 4 Diesel, 1997 cm³ 62 88 kW (84 120 PS) DW10BTED4 <u>1999 - 2007</u></p> <p>(2.0HDI) Berlingo C4 16V C4 GrandPicasso 16V C4 Picasso 16V C5 16V C8 16V Jumpy 6V C-Max Kuga 307 16V 307 CC 16V 308 16V 407 16V 508</p> 	<p>18-7551920 STD -mm 18-7551924 0,60 mm</p>	<p>A = 46,705 B = 80,705 C = 15,400 E = -0,520 CD= 44,800</p> <p>Ring Carrier Oil Gallery Oil Cut-Out</p>	<p>RE47440000 -STD RE47440060 -0,60</p> <p>3,500 (505) Cr P 2,000 (501) P IFU 3,000 (604) Cr P</p>	<p>ø28,0 x 70,0</p>			
<p>ø85,00</p> <p>4 Cyl. Diesel 1997 cc 163PS DW10CTED4 <u>2009 -</u></p> <p>3008 5008 C4 C5 III 2.0 HDI DS4 KUGA</p> 	<p>18-7592960 STD -mm 18-7592964 0,50 mm</p>	<p>A = 46,705 B = 74,705 C = 13,710 E = -0,455 CD= 50,400</p> <p>Ring Carrier Oil Gallery Oil Cut-Out</p>	<p>RE47770000 -STD RE47770060 -0,60</p> <p>2,000 () 2,000 () P 2,000 ()</p>	<p>ø30,0 x 68,0</p>			

Engine	Ref. No. - Kit 1	Dimensions	Rings	Pin	Piston Liner	Kit 2	Info
<p>ø86,00</p> <p>4 Cyl. Gasoline 1998 cc 88 Kw (121 Ps) XU10J2 XU10J2 TE XU 10J2 Z</p> <p><u>1993 -....</u></p> <p>Dizel 2446 cc Boxer 2,5 D 1996</p>	<p>18-7510860 STD -mm 18-7510863 0,50 mm 18-7510864 0,60 mm</p>	<p>A = 40,000 B = 64,850 C = 5,000</p>	<p>RE47130000 -STD RE47130025 -0,25 RE47130050 -0,50 RE47130060 -0,60</p> <p>1,500 (500) CrB S 1,750 (508) P 3,000 (700) Cr P S</p>	<p>ø22,0 x 62,0</p>			
<p>ø86,00</p> <p>R 4 Petrol, 1998 cm³ 98 kW (133 hp) XU10J4R</p> <p><u>1995 -....</u></p> <p>206 306 307 406 Boxer Partner</p>	<p>18-7510870 STD -mm 18-7510873 0,50 mm 18-7510874 0,60 mm</p>	<p>A = 33,800 B = 53,800 C = 4,300 E = -1,700 F = -2,000 CD= 52,000</p> <p>Oil Cut-Out</p>	<p>RE47130000 -STD RE47130025 -0,25 RE47130050 -0,50 RE47130060 -0,60</p> <p>1,500 (500) CrB S 1,750 (508) P 3,000 (700) Cr P S</p>	<p>ø22,0 x 62,0</p>			





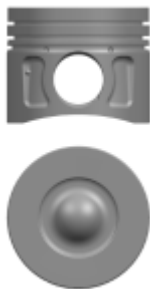



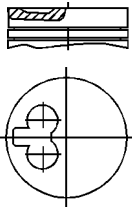

							
Engine	Ref. No. - Kit 1	Dimensions	Rings	Pin	Piston Liner	Kit 2	Info
<p>ø86,00</p> <p>4 Petrol, 1998 cm³ 120 kW (163 PS) 10:1 16 Ventile RFS (XU10J4RS) <u>05/1996 - 03/2005</u></p> <p><i>XSARA 2.0 I</i> <i>ZSARA 2.0 16 ZX 2.0 I</i></p>	<p>18-7510900 STD -mm 18-7510904 0,60 mm</p>	<p>A = 33,900 B = 58,400 C = 2,000 E = -1,740 F = -1,350 CD= 71,920</p> <p>Oil Cut-Out</p>	<p>RE43190000 -STD RE43190050 -0,50 RE43190100 -1,00</p> <p>1,500 (500) CrB S 1,500 (501) P 3,000 (700) Cr P S</p>	<p>ø22,0 x 62,0</p>			
<p>ø86,01</p> <p>4 Cyl. Diesel 2198 cc 100/120/130 Ps 17,5:1 QWFB/V347 Duratorq Euro 4 Duratorq/V347 D <u>2003/2008..</u></p> <p><i>Common Rail</i> <i>Transit 2.2 TDCI</i> <i>Yeni Jumper 2.2 HDI</i> <i>Ducato 100 Multijet</i> <i>Yeni Boxer HDI</i></p>	<p>18-2582350 STD -mm 18-2582350-20 STD -mm (0.2 mm SHORT) 18-2582351 0,25 mm 18-2582353 0,50 mm 18-2582353-20 0,50 mm (0.2 mm SHORT)</p>	<p>A = 43,420 B = 69,820 C = 15,850 CD= 46,900</p> <p>Ring Carrier Oil Gallery</p>	<p>RE23350000 -STD RE23350025 -0,25 RE23350050 -0,50</p> <p>2,000 (500) Cr P IF 2,000 (508) P 2,000 (604) Nit S</p>	<p>ø30,0 x 66,9</p>			<p>1,10 mm Gasket +0,38 +0,47</p> <p>1,20 mm Gasket +0,48 +0,58</p> <p>1,30 mm Gasket + 0,59 +0,68</p>

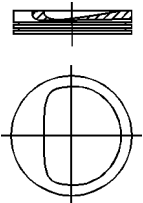

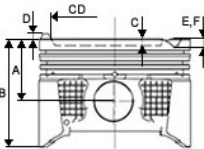





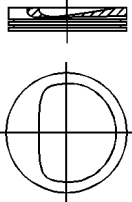



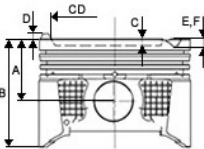





Engine	Ref. No. - Kit 1	Dimensions	Rings	Pin	Piston Liner	Kit 2	Info
<p>ø86,01</p> <p>4 Cyl. Gasoline 2198/2179 cc 155 PS 74 Kw (100 Ps) 15,5:1 2.2L Duratorq/HDI (CUFF,CUF5,CVR5,UYRG)) <u>2002 -</u></p> <p>Euro 5 TRANSIT 2.2 (YENI) Boxer 2.2L</p>	<p>18-2582420 STD -mm 18-2582420-20 STD -mm (0.2 mm SHORT) 18-2582421 0,25 mm 18-2582423 0,50 mm 18-2582423-20 0,50 mm (0.2 mm SHORT)</p>	<p>A = 48,420 B = 74,820 C = 16,170 CD= 49,040</p> <p>Ring Carrier Oil Gallery Oil Cut-Out</p>	<p>RE23350000 -STD RE23350025 -0,25 RE23350050 -0,50</p> <p>2,000 (500) Cr P IF 2,000 (508) P 2,000 (604) Nit S</p>	<p>ø30,0 x 66,9</p>			
<p>ø83,00</p> <p>R 4 Diesel, 1905 cm³ 55 69 kW (75 94 PS) XUD9ATF XUD9BSD XUD9BTF <u>1993 - 2004</u></p> <p>306 1.9 TD 405 1.9 TD 406 1.9 TD 806 1.9 TD Boxer 1.9 TD Ducato 1.9 TD</p>	<p>18-7550910 STD -mm 18-7550913 0,50 mm 18-7550917 0,80 mm</p>	<p>A = 46,750 B = 79,250 C = 3,500</p> <p>Hard Anodising</p>	<p>RE22250000 -STD RE22250050 -0,50 RE22250080 -0,80</p> <p>3,000 (504) Cr P 2,000 (501) P 3,000 (604) Cr P</p>	<p>ø28,0 x 68,0</p>			

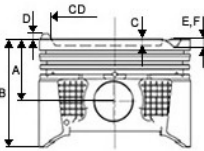

Engine	Ref. No. - Kit 1	Dimensions	Rings	Pin	Piston Liner	Kit 2	Info
<p>ø88,00</p> <p>4 Cyl. Gasoline 1971 cc 57 Kw (78 Ps) XN1P XNA XN1T XN2/3</p> <p><u>1971 - 1993</u></p>	<p>14-7510200 STD -mm 14-7510203 0,50 mm</p>	<p>A = 38,250 B = 71,850 D = 0,650</p>	<p>RE47160000 -STD RE47160050 -0,50</p> <p>1,500 (500) Cr 2,000 (501) 4,000 (700) Cr P S</p>	<p>ø23,0 x 74,1</p>			
<p>ø88,00</p> <p>4 Cyl. Gasoline 1971 cc 57 Kw (78 Ps) XN1T XN1 XN2</p> <p><u>1971 - 1993</u></p> <p>J5 J9 504</p>	<p>18-7510220 STD -mm</p>	<p>A = 37,900 B = 65,450 D = 2,550</p>	<p>RE47160000 -STD RE47160050 -0,50</p> <p>1,500 (500) Cr 2,000 (501) 4,000 (700) Cr P S</p>	<p>ø23,0 x 74,1</p>	<p>G93001356S_1</p> <p>A= 79,500 B= 75,000 D= 89,200 F= 0,000 H= 90,000 L= 135,000</p>		

							
Engine	Ref. No. - Kit 1	Dimensions	Rings	Pin	Piston Liner	Kit 2	Info
<p>ø92,00</p> <p>4 Cyl. Diesel 2446 cc DJ5TDI TED <u>1997 -....</u> Boxer 2,5 TD</p>	<p>18-7589220 STD -mm 18-7589223 0,50 mm</p>	<p>A = 57,000 B = 89,000 C = 18,250 E = -1,500 CD= 41,000</p> <p>Ring Carrier Oil Gallery</p>	<p>RE47520000 -STD RE47520050 -0,50</p> <p>3,500 (505) MoB N 2,000 (508) P 3,500 (604) Cr P</p>	<p>ø34,0 x 68,0</p>			<p>1,30 mm Gasket + 0,50 + 0,60</p>
<p>ø92,00</p> <p>4 Cyl. 2446 cc 76 96 Kw (103 130 Ps) Turbo DJ5T <u>1997 -....</u> Boxer 2,5 T Citroen Jumper 2,5 T</p>	<p>18-7589330 STD -mm 18-7589333 0,50 mm</p> 	<p>A = 49,840 C = 2,300</p> <p>Ring Carrier Hard Anodising Oil Gallery</p>	<p>RE47310000 -STD RE47310050 -0,50</p> <p>3,000 (504) MoB N IF 1,750 (501) Cr IF 3,500 (604) Cr P</p>	<p>ø34,0 x 68,0</p>			<p>+ 0,64 + 0,74</p>

							
Engine	Ref. No. - Kit 1	Dimensions	Rings	Pin	Piston Liner	Kit 2	Info
<p>ø93,03</p> <p>4 Cyl. Diesel 2498cc 54 kW (73 PS) 4JB1 <u>1981 - 1994</u> Karsan J9 Premier</p>	<p>14-7550870 STD -mm</p>	<p>A = 51,850 B = 91,850 C = 19,500 E = -0,550 CD= 43,900</p> <p>Ring Carrier Steel Support Oil Cut-Out</p>	<p>RE47420000 -STD RE47420050 -0,50</p> <p>2,000 (500) Cr P 2,000 (508) P 4,000 (604) Cr P</p>	<p>ø31,0 x 76,0</p>			<p>0 + 0,70</p>
<p>ø94,40</p> <p>4 Cyl. Diesel 2798 cc 64 Kw (87 Ps) Sofim Motor 8140.63.3700 <u>1998 - 1999</u> Ducato 14 2.8 D Ducato Maxi 2.8D</p>	<p>18-2051130 STD -mm 18-2051132 0,40 mm 18-2051134 0,60 mm</p>	<p>A = 55,000 B = 90,000 C = 1,700</p> <p>Ring Carrier Hard Anodising Oil Cut-Out</p>	<p>RE22790000 -STD RE22790040 -0,40 RE22790060 -0,60</p> <p>3,000 (504) Cr P 2,000 (501) P IWU 2,500 (604) Cr P</p>	<p>ø32,0 x 68,0</p>			<p>+ 0,40 + 0,50 (1.20 mm Gasket)</p> <p>+ 0,51 + 0,60 (1.30 mm Gasket)</p> <p>+ 0,61 + 0,70 (1.40 mm Gasket)</p>







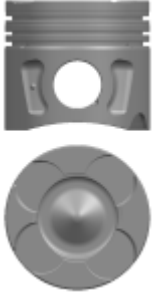
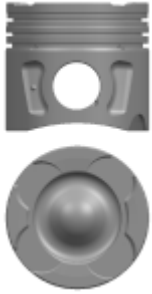

							
Engine	Ref. No. - Kit 1	Dimensions	Rings	Pin	Piston Liner	Kit 2	Info
<p>ø94,00</p> <p>4 Cyl. Diesel 2800 cc 180 ps 2.8 HP DODGE NITRO</p> <p>2.8 HP DODGE NITRO 2007/2008 GRAND KARAVAN iv 2008-2010 JEEP LIBERTE/CHEROKEE (KK) 2008-2009 CHEROKEE WRANGLER (JK) 2007-... CHRYSLER VOYAGER/VILLE&PAYS 2008-2010</p>	<p>18-9792010 STD -mm 18-9792013 0,50 mm</p>	<p>A = 52,000 B = 80,000 C = 17,000 E = -1,000 F = -1,000 CD= 52,200</p> <p>Ring Carrier Oil Gallery</p>	<p>RE04000000 -STD RE04000050 -0,50</p> <p>2,500 (500) Cr P 1,500 (501) P 2,000 (2)G GN</p>	<p>ø32,0 x 74,0</p>			
<p>ø94,00</p> <p>4 Cyl. Diesel 2800 cc 180 ps 2.8 HP DODGE NITRO</p> <p>2.8 HP DODGE NITRO 2007/2008 GRAND KARAVAN iv 2008-2010 JEEP LIBERTE/CHEROKEE (KK) 2008-2009 CHEROKEE WRANGLER (JK) 2007-... CHRYSLER VOYAGER/VILLE&PAYS 2008-2010</p>	<p>18-9792010 STD -mm 18-9792013 0,50 mm</p>	<p>A = 52,000 B = 80,000 C = 17,000 E = -1,000 F = -1,000 CD= 52,200</p> <p>Ring Carrier Oil Gallery</p>	<p>RE04000000 -STD RE04000050 -0,50</p> <p>2,500 (500) Cr P 1,500 (501) P 2,000 (2)G GN</p>	<p>ø32,0 x 74,0</p>			



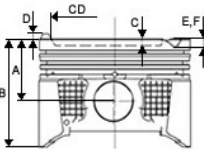





Engine	Ref. No. - Kit 1	Dimensions	Rings	Pin	Piston Liner	Kit 2	Info
<p>ø65,00</p> <p>4 Cyl. Gasoline 903/899cc 30/29kw 41/39 PS 170 A1.000 170 A1.046 1170 A1.046 <u>0492-1296</u></p> <p><i>Panda 900 (04/92-12/96) Secento/600 0.9 (01/98-01/10) Cinquecento 0.9/i.e (07/91-12/93) Cinquecento 0.9 i.e.S (07/91-07/99)</i></p> 	<p>14-2010530 STD -mm 14-2010532 0,40 mm 14-2010534 0,60 mm</p>	<p>A = 31,250 B = 54,250</p>	<p>RE22000000 -STD RE22000040 -0,40 RE22000060 -0,60</p> <p>1,500 (500) CrV S IF 1,500 (508) P 3,000 (700) Cr P S</p>	<p>ø22,0 x 58,2</p>			
<p>ø65,00</p> <p>R 4 Petrol 903 cm³ 33 kW (45 hp) 9:1 146 A.000 <u>1984-1989</u></p> <p><i>Panda I 900 Uno 45 127 Fiorino</i></p>	<p>14-2010540 STD -mm 14-2010542 0,40 mm 14-2010544 0,60 mm</p>	<p>A = 31,250 B = 61,750</p>	<p>RE22010000 -STD RE22010025 -0,25 RE22010040 -0,40 RE22010060 -0,60 RE22010080 -0,80 RE22010100 -1,00</p> <p>1,750 (500) CrBFes IF 2,000 (508) P 3,947 (700) Cr P S</p>	<p>ø20,0 x 54,0</p>			

Engine	Ref. No. - Kit 1	Dimensions	Rings	Pin	Piston Liner	Kit 2	Info
<p>ø65,00</p> <p>R 4 Petrol 903 cm³ 38 kW (52 hp)</p> <p>100.G.000 100.GB.000 100.GC.000 100.GF.000 100.GL.</p> <p><u>1968-1973</u></p> <p>Panda/900 Uno 127 Fiorino</p>	<p>18-2010550 STD -mm 18-2010551 0,25 mm 18-2010552 0,40 mm 18-2010554 0,60 mm 18-2010557 0,80 mm 18-2010558 1,00 mm</p>	<p>A = 30,750 B = 61,950 D = 0,700</p>	<p>RE22010000 -STD RE22010025 -0,25 RE22010040 -0,40 RE22010060 -0,60 RE22010080 -0,80 RE22010100 -1,00</p> <p>1,750 (500) CrBFeS IF 2,000 (508) P 3,947 (700) Cr P S</p>	<p>ø20,0 x 54,0</p>			
<p>ø69,60</p> <p>4 Cyl. Diesel 1248 cc 70 Ps 18:1 Turbo, Common Rail 16v 188.A8.000 Euro 4 188 A9.000 Euro 4 199 A2.000 Eur</p> <p><u>2003 -....</u></p> <p>Agila 1.3 Corsa 1.3 Meriva 1.3 Tigra 1.3 Albea 1.3 Multijet Doblo 1.3 Multijet Palio 1.3 Multijet Idea 1.3 JTD Punto/EVO/Grand (188) (199) 1.3 JTD/D Fiorino 1.3 JTD</p>	<p>18-2050230 STD -mm 18-2050230-20 STD -mm (0.2 mm SHORT) 18-2050230-40 STD -mm (0.4 mm SHORT) 18-2050232 0,40 mm 18-2050232-20 0,40 mm (0.2 mm SHORT) 18-2050232-40 0,40 mm (0.4 mm SHORT) 18-2050237 0,80 mm 18-2050237-20 0,80 mm (0.2 mm SHORT) 18-2050237-40 0,80 mm (0.4 mm SHORT)</p>	<p>A = 40,430 B = 63,430 C = 12,400 E = -1,000 F = -1,200 CD= 37,000</p> <p>Ring Carrier Oil Cut-Out</p>	<p>RE22030000 -STD RE22030040 -0,40 RE22030060 -0,60 RE22030080 -0,80</p> <p>2,000 (500) Cr P 1,500 (501) P 2,000 (604) Nit S</p>	<p>ø23,0 x 56,7</p>			<p>0,67 0,77 mm Gasket +0,02 +0,13</p> <p>0,77 0,87 mm Gasket +0,13 +0,23</p> <p>0,87 0,97 mm Gasket +0,23 +0,33</p>

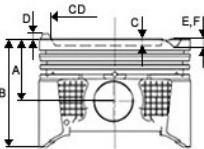
Engine	Ref. No. - Kit 1	Dimensions	Rings	Pin	Piston Liner	Kit 2	Info
<p>ø69,60</p> <p>4 Cyl. Diesel 1248cc 75 HP/95 70Kw 16,8:1 1.3 75Hp Multi-jet II 16v Euro 5 95 PS A 13DTE <u>2009 -</u></p> <p>1.3 CDTi Stop/Start Motorolara Ait (Astra J Corsa D Meriva) 1.3 CDTi (Astra J Corsa D Meriva) 1.3 D Multijet MITO STRADA Pick-up PANDA FIORINO Kasten/Kombi QUBO IDEA PUNTO Van AVEO Schrägheck(Euro-4)1</p>	<p>18-2092250 STD -mm 18-2092250-20 STD -mm (0.2 mm SHORT) 18-2092250-40 STD -mm (0.4 mm SHORT) 18-2092252 0,40 mm 18-2092252-20 0,40 mm (0.2 mm SHORT) 18-2092252-40 0,40 mm (0.4 mm SHORT) 18-2092257 0,80 mm 18-2092257-20 0,80 mm (0.2 mm SHORT) 18-2092257-40 0,80 mm (0.4 mm SHORT)</p> 	<p>A = 40,430 B = 62,430 C = 12,700 E = -1,153 F = -0,904 CD= 37,000</p> <p>Ring Carrier Oil Gallery Oil Cut-Out</p>	<p>RE22860000 -STD RE22860040 -0,40 RE22860060 -0,60 RE22860080 -0,80 RE22860100 -1,00</p> <p>1,500 (500) Cr P 1,500 (501) P 2,000 (604) Nit S</p>	<p>ø23,0 x 56,7</p>		<p>0,67 0,77 mm Gasket Yle</p> <p>+ 0,028 + 0,127 0,77 0,87 mm Gasket</p> <p>+0,127 +0,227 0,87 0,97 mm Gasket</p> <p>+ 0,228 + 0,327</p>	
<p>ø69,60</p> <p>4 Cyl. Diesel 1248cc 75 HP 55/70 KW 75/95 PS B13 DTE/DTR 1.3 CDTi (EUR 6) <u>2006 -</u></p> <p>1.3 CDTi CORSA E Van (X15) CORSA E (X15) CORSAVAN Mk III (D) (S07) CORSAVAN MkIV E (X15) CORSAVAN Mk IV € (X15)</p>	<p>18-2092260 STD -mm 18-2092260-20 STD -mm (0.2 mm SHORT) 18-2092260-40 STD -mm (0.4 mm SHORT) 18-2092262 0,40 mm 18-2092262-20 0,40 mm (0.2 mm SHORT) 18-2092262-40 0,40 mm (0.4 mm SHORT) 18-2092267 0,80 mm 18-2092267-20 0,80 mm (0.2 mm SHORT) 18-2092267-40 0,80 mm (0.4 mm SHORT)</p> 	<p>A = 40,430 B = 62,430 C = 12,000 CD= 42,300</p> <p>Ring Carrier Oil Gallery Oil Cut-Out</p>	<p>RE22860000 -STD RE22860040 -0,40 RE22860060 -0,60 RE22860080 -0,80 RE22860100 -1,00</p> <p>1,500 (500) Cr P 1,500 (501) P 2,000 (604) Nit S</p>	<p>ø23,0 x 56,7</p>			

Engine	Ref. No. - Kit 1	Dimensions	Rings	Pin	Piston Liner	Kit 2	Info
<p>ø69,60</p> <p>4 Cyl. Diesel 1248cc 90 HP 1.3 90HP MULTIJET II 1.6V EURO 5 <u>2009 -</u></p> <p>Stop/Start Motorolara Ait DOBLO CARGO PRATICO</p>	<p>18-2092320 STD -mm 18-2092320-20 STD -mm (0.2 mm SHORT)</p> <p>18-2092320-40 STD -mm (0.4 mm SHORT)</p> <p>18-2092322 0,40 mm 18-2092322-20 0,40 mm (0.2 mm SHORT)</p> <p>18-2092322-40 0,40 mm (0.4 mm SHORT)</p> <p>18-2092327 0,80 mm 18-2092327-20 0,80 mm (0.2 mm SHORT)</p> <p>18-2092327-40 0,80 mm (0.4 mm SHORT)</p>	<p>A = 40,300 B = 62,430 C = 12,700 E = -1,153 F = -0,904 CD= 37,000</p> <p>Ring Carrier Oil Gallery Oil Cut-Out</p>	<p>RE22860000 -STD RE22860040 -0,40 RE22860060 -0,60 RE22860080 -0,80 RE22860100 -1,00</p> <p>1,500 (500) Cr P 1,500 (501) P 2,000 (604) Nit S</p>	<p>ø23,0 x 56,7</p>		<p>0,67 0,77 mm Gasket Yle</p> <p>+ 0,028 + 0,127 0,77 0,87 mm Gasket</p> <p>+0,127 +0,227 0,87 0,97 mm Gasket</p> <p>+ 0,228 + 0,327</p>	
<p>ø69,60</p> <p>4 Cyl. Diesel 1248 cc 70 Ps 18:1 Turbo, Common Rail 16v 188.A8.000 Euro 4 188 A9.000 Euro 4 199 A2.000 Eur <u>2003 -....</u></p> <p>Agila 1.3 Corsa 1.3 Meriva 1.3 Tigra 1.3 Albea 1.3 Multijet Doblo 1.3 Multijet Palio 1.3 Multijet Suzuki 1.3 Multijet</p>	<p>18-3050230 STD -mm 18-3050230-20 STD -mm (0.2 mm SHORT)</p> <p>18-3050230-40 STD -mm (0.4 mm SHORT)</p> <p>18-3050232 0,40 mm 18-3050232-20 0,40 mm (0.2 mm SHORT)</p> <p>18-3050232-40 0,40 mm (0.4 mm SHORT)</p> <p>18-3050234 0,60 mm 18-3050234-20 0,60 mm (0.2 mm SHORT)</p> <p>18-3050234-40 0,60 mm (0.4 mm SHORT)</p> <p>18-3050237 0,80 mm 18-3050237-20 0,80 mm (0.2 mm SHORT)</p> <p>18-3050237-40 0,80 mm (0.4 mm SHORT)</p>	<p>A = 40,430 B = 63,430 C = 12,400 E = -1,000 F = -1,200 CD= 38,000</p> <p>Ring Carrier Oil Cut-Out</p>	<p>RE22030000 -STD RE22030040 -0,40 RE22030060 -0,60 RE22030080 -0,80</p> <p>2,000 (500) Cr P 1,500 (501) P 2,000 (604) Nit S</p>	<p>ø23,0 x 56,7</p>		<p>0,67 0,77 mm Gasket +0,02 +0,13</p> <p>0,77 0,87 mm Gasket +0,13 +0,23</p> <p>0,87 0,97 mm Gasket +0,23 +0,33</p>	







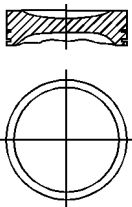
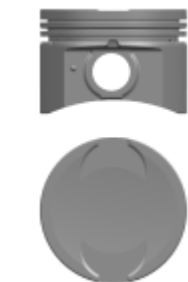

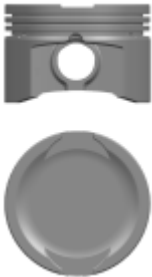
							
Engine	Ref. No. - Kit 1	Dimensions	Rings	Pin	Piston Liner	Kit 2	Info
<p>ø69,60</p> <p>4 Cyl. Diesel 1248 cc 66 Kw (90 Ps) 17,6:1 199A3000 Multijet Euro 5 Z13 DTH A13DTE Euro 5 16V <u>2009-....</u></p> <p>ASTRA J CORSA D Grande Punto1.3CDTI 16V Linea Grande Punto</p>	<p>18-3082550 STD -mm <i>18-3082550-20 STD -mm (0.2 mm SHORT)</i> 18-3082550-40 STD -mm <i>(0.4 mm SHORT)</i> 18-3082552 0,40 mm <i>18-3082552-20 0,40 mm (0.2 mm SHORT)</i> <i>18-3082552-40 0,40 mm (0.4 mm SHORT)</i> 18-3082557 0,80 mm <i>18-3082557-20 0,80 mm (0.2 mm SHORT)</i> <i>18-3082557-40 0,80 mm (0.4 mm SHORT)</i></p>	<p>A = 40,430 B = 62,430 C = 12,400 E = -0,904 F = -1,154 CD= 38,000</p> <p>Ring Carrier Oil Gallery Oil Cut-Out</p>	<p>RE22030000 -STD RE22030040 -0,40 RE22030060 -0,60 RE22030080 -0,80</p> <p>2,000 (500) Cr P 1,500 (501) P 2,000 (604) Nit S</p>	<p>ø23,0 x 56,7</p>			<p>0,67 0,77 mm Gasket Yle +0,028 +0,127</p> <p>0,77 0,87 mm Gasket +0,127 +0,227</p> <p>0,87 0,97 mm Gasket +0,228 +0,327</p>
<p>ø70,00</p> <p>R 4 Petrol 999 cm³ 33/37 kW (45/50 hp) 9:1 9 8:1 8 Ventile 156 A2/A3.000 M 204 AA/BA 10/0 XO 125 <u>1985-1995</u></p> <p>Panda 1000 Uno</p>	<p>18-2010140 STD -mm 18-2010142 0,40 mm 18-2010144 0,60 mm</p>	<p>A = 33,900 B = 57,400 C = 0,500 CD= 55,000</p> <p>Steel Support</p>	<p>RE22040000 -STD RE22040040 -0,40 RE22040060 -0,60</p> <p>1,500 (500) CrBFe S IF 1,500 (501) P 3,000 (700) Cr P S</p>	<p>ø18,0 x 53,0</p>			

							
Engine	Ref. No. - Kit 1	Dimensions	Rings	Pin	Piston Liner	Kit 2	Info
<p>ø70,00</p> <p>R 4 Petrol 1108 cm³ 41 kW (56 hp) 9 6:1 160 A3.000 M 204 AA 11/0 <u>1988-1993</u></p> <p><i>Tipo 1.1</i> <i>Uno 60 Fire</i></p>	<p>14-2010150 STD -mm 14-2010152 0,40 mm</p>	<p>A = 30,000 B = 53,500 C = 1,800 CD= 60,000</p>	<p>RE22040000 -STD RE22040040 -0,40 RE22040060 -0,60</p> <p>1,500 (500) CrBFe S IF 1,500 (501) P 3,000 (700) Cr P S</p>	<p>ø18,0 x 53,0</p>			
<p>ø70,00</p> <p>R 4 Petrol 999 cm³ 32 34 kW (44 46 hp) 156 A2.046 <u>1985-1993</u></p> <p><i>Panda 1000</i> <i>Uno 45</i></p>	<p>14-2010160 STD -mm 14-2010162 0,40 mm</p>	<p>A = 33,900 B = 57,400 C = 1,500 CD= 55,000</p>	<p>RE22040000 -STD RE22040040 -0,40 RE22040060 -0,60</p> <p>1,500 (500) CrBFe S IF 1,500 (501) P 3,000 (700) Cr P S</p>	<p>ø18,0 x 53,0</p>			

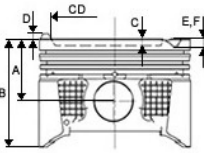







Engine	Ref. No. - Kit 1	Dimensions	Rings	Pin	Piston Liner	Kit 2	Info
<p>ø70,00</p> <p>R 4 Petrol 1108 cm³ 37 40 kW (50 54 hp) 176 A6.000 176 B2.000 187 A1.000 <u>1992-....</u></p> <p><i>Panda I 1100 Panda II 1.1 Punto I 1.1</i></p>	<p>18-2010180 STD -mm 18-2010182 0,40 mm 18-2010184 0,60 mm</p>	<p>A = 30,000 B = 50,000 C = 1,500 E = -0,700 CD= 60,000</p>	<p>RE22640000 -STD RE22640040 -0,40 RE22640060 -0,60</p> <p>1,200 (500) CrB Fe S IF 1,200 (508) P 2,500 (700) Nit S</p>	<p>ø18,0 x 53,0</p>			
<p>ø70,00</p> <p>R 4 Petrol 999 cm³ 33 kW (45 hp) 9 8:1 M204 AA 10.0 <u>1985-1991</u></p> <p><i>Panda 1000</i></p>	<p>14-2010710 STD -mm</p>	<p>A = 33,900 B = 57,400 C = 0,500 CD= 55,000</p>	<p>RE22040000 -STD RE22040040 -0,40 RE22040060 -0,60</p> <p>1,500 (500) CrBFe S IF 1,500 (501) P 3,000 (700) Cr P S</p>	<p>ø20,6 x 66,7</p>			

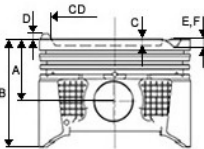

Engine	Ref. No. - Kit 1	Dimensions	Rings	Pin	Piston Liner	Kit 2	Info
<p>ø70,80</p> <p>4 Cyl. Gasoline 1242 cc 59 Kw 80 Ps 188.A5.000 <u>1999 - 2005</u></p> <p><i>Albea 1.2 16v Brava 1.2 16v Bravo 1.2 16v Idea 1.2 16v Palio 1.2 16v Punto 1.2 16v Stilo 1.2 16v</i></p> 	<p>18-2010170 STD -mm 18-2010172 0,40 mm 18-2010174 0,60 mm</p>	<p>A = 28,000 B = 48,000 C = 5,100 E = -2,000</p>	<p>RE22650000 -STD RE22650040 -0,40 RE22650060 -0,60</p> <p>1,200 (500) CrB P S IF 1,200 (501) P 2,500 (700) Cr P S</p>	<p>ø18,0 x 53,0</p>			
<p>ø70,80</p> <p>4 Cyl. Gasoline 1241 cc 44 Kw (60 Ps) 9 8:1 188.A4.000 <u>2000-....</u></p> <p><i>Albea 1.2 8v Palio 1.2 8v Doblo 1.2 8v Siena 1.2 8v</i></p> 	<p>18-2010190 STD -mm 18-2010192 0,40 mm 18-2010194 0,60 mm</p>	<p>A = 28,000 B = 48,000 C = 2,000 E = -1,400 CD= 60,500</p>	<p>RE22650000 -STD RE22650040 -0,40 RE22650060 -0,60</p> <p>1,200 (500) CrB P S IF 1,200 (501) P 2,500 (700) Cr P S</p>	<p>ø18,0 x 53,0</p>			

							
Engine	Ref. No. - Kit 1	Dimensions	Rings	Pin	Piston Liner	Kit 2	Info
<p>ø70,80</p> <p>4 Gasoline, 1242 cc 48kW 65 ps 199 A4.000 <u>2005</u> <i>Punto EVO 1.2 Grande Punto 1.2i</i></p>	<p>18-2010200 STD -mm 18-2010202 0,40 mm 18-2010204 0,60 mm</p>	<p>A = 18,000 B = 48,000 C = 3,950 CD= 47,000</p>	<p>RE22650000 -STD RE22650040 -0,40 RE22650060 -0,60</p> <p>1,200 (500) CrB P S IF 1,200 (501) P 2,500 (700) Cr P S</p>	<p>ø18,0 x 53,0</p>			
<p>ø72,00</p> <p>4 Cyl. Gasoline 1368 cc 57 Kw (77 HP) 350.A1.000 Euro 4 <u>2003-....</u> <i>Albea 1.4 8v Doblo 1.4 8v Idea 1.4 8v Palio 1.4 8v Grande Punto 1.4 8v</i></p>	<p>18-2010210 STD -mm 18-2010212 0,40 mm</p>	<p>A = 26,000 B = 49,000 C = 4,750 E = -2,050</p>	<p>RE22050000 -STD RE22050040 -0,40</p> <p>1,000 (500) NitB S IF 1,200 (508) P 2,000 (604) Nit S</p>	<p>ø18,0 x 49,0</p>			





							
Engine	Ref. No. - Kit 1	Dimensions	Rings	Pin	Piston Liner	Kit 2	Info
<p>ø72,00</p> <p>4 Cyl. Gasoline 1368 cc 57 Kw (77 HP) 843.A1.000 <u>2003-....</u> 500 L 1.4 16v Doblo 1.4 16v Idea 1.4 16v Punto II 1.4 16v Stilo 1.4 16v</p>	<p>18-2010220 STD -mm 18-2010222 0,40 mm</p>	<p>A = 26,800 B = 49,800 C = 8,000 E = -1,400 F = -2,300 CD= 61,000</p>	<p>RE22810000 -STD RE22810040 -0,40</p> <p>1,200 (500) Cr P 1,200 (508) P 2,000 (604) Cr P S</p>	<p>ø18,0 x 53,0</p>			
<p>ø76,00</p> <p>4 Cyl. Gasoline 1297 cc 41/52 Kw (55/70 Ps) 131 A.000 <u>1981-....</u> Murat 131 Serçe</p>	<p>14-2010260 STD -mm 14-2010262 0,40 mm</p>	<p>A = 38,450 B = 77,950 D = 0,500 CD= 45,000</p>	<p>RE22080000 -STD RE22080040 -0,40 RE22080060 -0,60</p> <p>1,500 (500) Cr S 2,000 (508) P 3,947 (700) Cr P S</p>	<p>ø22,0 x 61,0</p>			











Engine	Ref. No. - Kit 1	Dimensions	Rings	Pin	Piston Liner	Kit 2	Info
<p>ø79,50</p> <p>4 Cyl. Diesel 1598 cc 74 KW 100 PS 16:5 1.6 16V Multi.jet (EURO 5) <u>2010 -</u> <i>Bravo 1.6 16v Doblo II 1.6 16V Linea 1.616V</i></p>	<p>18-2050040 STD -mm 18-2050042 0,40 mm</p>	<p>A = 43,950 B = 68,950 C = 13,800 E = -0,460 F = -0,600 CD= 41,700</p> <p>Ring Carrier</p>	<p>RE22880000 -STD RE22880040 -0,40 RE22880060 -0,60</p> <p>1,500 (500) CrP 1,500 (508) P 2,000 (604) Nits</p>	<p>ø26,0 x 62,8</p>			<p>Holesiz Gasket (0,82 mm) +0,02 +0,10</p> <p>Tek delik Gasket (0,92 mm) +0,10 +0,20</p> <p>Yki delik Gasket +0,20 +0,30</p>
<p>ø80,00</p> <p>4.sil.benzin 1100 cc 128 A.000 128 AC 5.000 138 A.000 <u>12/75 - 01/80</u> <i>128-138-Uno 55 Ritmo 60</i></p>	<p>18-2010030 STD -mm 18-2010032 0,40 mm 18-2010034 0,60 mm 18-2010037 0,80 mm 18-2010038 1,00 mm</p>	<p>A = 34,700 B = 77,300 D = 0,600 E = -2,600</p>	<p>RE22130000 -STD RE22130040 -0,40 RE22130060 -0,60 RE22130080 -0,80 RE22130100 -1,00</p> <p>1,500 (500) CrB Fe S 2,000 (508) P 3,940 (700) Cr P S</p>	<p>ø21,9 x 71,0</p>			

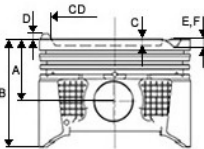





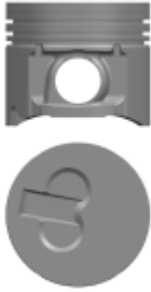
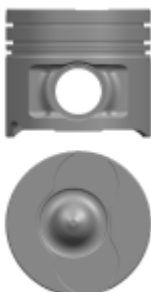

Engine	Ref. No. - Kit 1	Dimensions	Rings	Pin	Piston Liner	Kit 2	Info
<p>ø80,00</p> <p>4,sil.benzin 1100 cc 138 B 1.000 <u>1983...1987</u> <i>Ritmo ES</i></p>	<p>14-2010080 STD -mm</p>	<p>A = 35,050 B = 75,150 C = 0,600</p>	<p>RE22130000 -STD RE22130040 -0,40 RE22130060 -0,60 RE22130080 -0,80 RE22130100 -1,00</p> <p>1,500 (500) CrB Fe S 2,000 (508) P 3,940 (700) Cr P S</p>	<p>ø22,0 x 71,0</p>			
<p>ø80,00</p> <p>4 Cyl.Gasoline 1116cc 41 Kw (56 Ps) 2 Cyl.Gasoline704cc 17/22Kw (24/30 Ps) 170 A.000/A.046 171.A.000 126A2.000 024AA.07A0 138A/B.000 <u>93-96/87-92/83-89</u> <i>Cinquecento 700 ED 126 Bis 700 Regata 60 Uno 55/55S/60</i></p>	<p>14-2010090 STD -mm</p>	<p>A = 34,000 B = 60,000</p>	<p>RE22130000 -STD RE22130040 -0,40 RE22130060 -0,60 RE22130080 -0,80 RE22130100 -1,00</p> <p>1,500 (500) CrB Fe S 2,000 (508) P 3,940 (700) Cr P S</p>	<p>ø20,0 x 54,0</p>			

Engine	Ref. No. - Kit 1	Dimensions	Rings	Pin	Piston Liner	Kit 2	Info
<p>ø80,50</p> <p>4.Cyl. Gasoline 1372 cc 45 Kw (60 Ps) M202 PA 13.0 M605PB.13.J014 160A1.000 <u>1990-1994</u></p> <p><i>Tipo 1.4 Uno 70 Uno S Uno SX Tipo 1.4 ie Tempra</i></p> 	<p>18-2010800 STD -mm 18-2010802 0,40 mm 18-2010804 0,60 mm</p>	<p>A = 33,300 B = 63,500 C = 2,800 D = 71,000 F = -3,050</p>	<p>RE22150000 -STD RE22150040 -0,40 RE22150060 -0,60</p> <p>1,500 (500) CrB S IF 1,750 (508) P 3,000 (700) Cr P S</p>	<p>ø22,0 x 58,2</p>			
<p>ø80,50</p> <p>R 4 Petrol 1372 cm³ 84 100 kW (114 136 hp) 7 8:1 M603 BT 13.0 <u>1990-1993</u></p> <p><i>Uno Turbo Punto GT</i></p> 	<p>14-2010820 STD -mm 14-2010822 0,40 mm 14-2010824 0,60 mm</p>	<p>A = 33,300 B = 61,300 C = 2,000 E = -3,500 CD= 70,500</p>	<p>RE22670000 -STD RE22670040 -0,40 RE22670060 -0,60</p> <p>1,500 (500) CrSIF 2,000 (501) Fe 3,000 (700) Cr P S</p>	<p>ø22,0 x 58,0</p>			

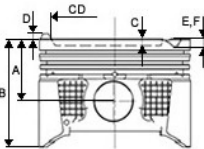

Engine	Ref. No. - Kit 1	Dimensions	Rings	Pin	Piston Liner	Kit 2	Info
<p>ø80,50</p> <p>R 4 Petrol 1301 cm³ 74 kW (100 hp) 7 7:1 M/603 AT 13/0 <u>1985-1991</u> Uno 1,3 Turbo</p>	<p>14-2010830 STD -mm 14-2010832 0,40 mm 14-2010834 0,60 mm</p>	<p>A = 35,000 B = 63,050 C = 3,250</p>	<p>RE22140000 -STD RE22140040 -0,40 RE22140060 -0,60</p> <p>1,500 (500) Cr S IF 2,000 (508) P 4,000 (604) Cr P</p>	<p>ø22,0 x 58,0</p>			
<p>ø80,50</p> <p>4 Cyl. Gasoline 1596 cc 76 Kw (103 Ps) 182/B6/000 <u>1997-2003</u> Brava 1,6 16v Bravo 1,6 16v Doblo 1,6 16v Marea 1,6 16v Palio 1,6 16v Stilo 1,6 16v</p>	<p>18-2010840 STD -mm 18-2010841 0,25 mm 18-2010842 0,40 mm</p>	<p>A = 28,650 B = 50,700 C = 1,200 E = -2,200 F = -2,800</p>	<p>RE22760000 -STD RE22760040 -0,40</p> <p>1,200 (500) NitB S IF 1,200 (508) P 2,000 (700) Nit S</p>	<p>ø21,0 x 56,0</p>			







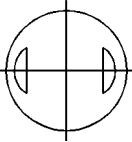

							
Engine	Ref. No. - Kit 1	Dimensions	Rings	Pin	Piston Liner	Kit 2	Info
<p>ø80,50</p> <p>4 Cyl. Gasoline 1372 cc Şahin S (Oyüklu) 138 <u>1992 -</u> Şahin S 1,4</p>	<p>18-2010930 STD -mm 18-2010932 0,40 mm 18-2010934 0,60 mm 18-2010935 0,65 mm</p>	<p>A = 33,300 B = 63,500 C = 2,900 CD= 71,000</p>	<p>RE22150000 -STD RE22150040 -0,40 RE22150060 -0,60</p> <p>1,500 (500) CrB S IF 1,750 (508) P 3,000 (700) Cr P S</p>	<p>ø22,0 x 58,2</p>			
<p>ø82,00</p> <p>R 4 Diesel 1910 cm³ 76 kW (104 hp) 18 5:1 M724 BT 19/T M722 BT 24/T <u>1998-2000</u> Brava Bravo Doblo Marea</p>	<p>14-2050930 STD -mm 14-2050932 0,40 mm 14-2050934 0,60 mm</p>	<p>A = 47,250 B = 73,250 C = 17,500 CD= 37,500</p> <p>Ring Carrier Oil Cut-Out</p>	<p>RE22700000 -STD RE22700040 -0,40 RE22700060 -0,60</p> <p>3,000 (504) Cr P 2,000 (501) P IFU 3,000 (604) Cr P</p>	<p>ø26,0 x 61,0</p>			

Engine	Ref. No. - Kit 1	Dimensions	Rings	Pin	Piston Liner	Kit 2	Info
<p>ø82,00</p> <p>4 Cyl. Diesel 1910 cc 63 Ps 22 6:1 223A.6000 <u>2000-....</u> <i>Doblo 1.9 D</i></p>	<p>18-2050960 STD -mm <i>18-2050960-20 STD -mm (0.2 mm SHORT)</i></p> <p>18-2050962 0,40 mm <i>18-2050962-20 0,40 mm (0.2 mm SHORT)</i></p> <p>18-2050964 0,60 mm <i>18-2050964-20 0,60 mm (0.2 mm SHORT)</i></p> <p>18-2050967 0,80 mm <i>18-2050967-20 0,80 mm (0.2 mm SHORT)</i></p> 	<p>A = 44,500 B = 70,300 C = 1,300</p>	<p>RE22730000 -STD RE22730040 -0,40 RE22730060 -0,60 RE22730080 -0,80 RE22730100 -1,00</p> <p>2,000 (500) Cr P 2,000 (508) P 2,000 (604) Cr P</p>	<p>ø26,0 x 65,0</p>			<p>0,76 0,84 mm Gasket + 0,045 + 0,125</p> <p>0,86 0,94 mm Gasket + 0,126 + 0,225</p> <p>0,96 1,04 mm Gasket + 0,226 + 0,305</p>
<p>ø82,00</p> <p>4 Cyl. Diesel 1910 cc 77 Kw (103 Ps) Z19DT 182B.9000 <u>2001-....</u> <i>Doblo 1.9 JTD</i></p>	<p>18-3051940 STD -mm 18-3051942 0,40 mm 18-3051947 0,80 mm</p> 	<p>A = 46,500 B = 72,500 C = 17,450 E = -0,650 CD= 37,550</p> <p>Ring Carrier Bushing</p>	<p>RE22730000 -STD RE22730040 -0,40 RE22730060 -0,60 RE22730080 -0,80 RE22730100 -1,00</p> <p>2,000 (500) Cr P 2,000 (508) P 2,000 (604) Cr P</p>	<p>ø26,0 x 61,0</p>			<p>0,77 0,87mm Gasket +0,014 +0,104</p> <p>0,87 0,97mm Gasket +0,105 +0,205</p> <p>0,97 1,07mm Gasket +0,236 +0,294</p>

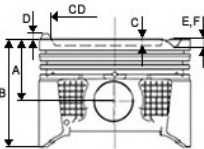





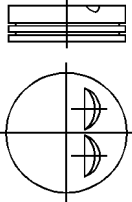

							
Engine	Ref. No. - Kit 1	Dimensions	Rings	Pin	Piston Liner	Kit 2	Info
<p>ø82,00</p> <p>4 Cyl. Diesel 1900 cc 110 Kw 1/9 JTD Euro 4 16 V <u>2000 -....</u></p> <p><i>Astra Zafira Vectra&Signum Signum Vectra Zafira Doblo 1.9 JTD Bravo 1.9 JTD Stilo 1.9 JTD</i></p>	<p>18-3083440 STD -mm 18-3083442 0,40 mm</p>	<p>A = 46,500 B = 72,500 C = 15,400 E = -1,070 F = -1,020 CD= 41,500</p> <p>Ring Carrier Oil Gallery</p>	<p>RE22730000 -STD RE22730040 -0,40 RE22730060 -0,60 RE22730080 -0,80 RE22730100 -1,00</p> <p>2,000 (500) Cr P 2,000 (508) P 2,000 (604) Cr P</p>	<p>ø30,0 x 67,0</p>			
<p>ø82,60</p> <p>4 Gasoline, 1698 cc 40/42/44 48/52/59/62kW 57/58/60/65 70/80/82 ps 138C.000 146 B2.000 149/176 B3/B4.000 149/280 A1/B1.000 160 A7.000 M705BA.190 149 B5.046 831D/D1.000 <u>1984</u></p> <p><i>Tempra 1.7D Marengo/Talento/1.9D Uno/Tipo/Bravo/Bravo Prisma D/Delta 1.9D Ducato 10-14 1.9D-Turbo Strada/Duna/Siena 1.7D /Punto/Palio Mondo 1.7D Uno 1.7D/60 1.7D Ritmo/Regata 1.7D 60 1.7D/65-80 1.9D</i></p>	<p>18-2050940 STD -mm 18-2050942 0,40 mm 18-2050944 0,60 mm</p>	<p>A = 42,600 B = 84,400 D = 2,400</p>	<p>RE22170000 -STD RE22170040 -0,40 RE22170060 -0,60 RE22170080 -0,80</p> <p>2,500 (504) Cr 2,000 (508) P 4,000 (604) Cr P</p>	<p>ø25,0 x 69,5</p>			

Engine	Ref. No. - Kit 1	Dimensions	Rings	Pin	Piston Liner	Kit 2	Info
<p>ø83,00</p> <p>4 Cyl. Diesel 1956 cc 100 125 KW 136 170Ps 16,5:1 198 A5.000 A 20DTH 939B 5.000/940A 5.000 <u>2008 -</u></p> <p><i>Freemont Astra J Insignia 2.0 CDTI 16V Zafira MK III 2.0 CDTI</i></p>	<p>18-2092650 STD -mm 18-2092652 0,40 mm 18-2092653 0,50 mm</p>	<p>A = 46,630 B = 72,630 C = 15,800 E = -1,171 F = -1,220 CD= 43,500</p> <p>Ring Carrier Oil Gallery</p>	<p>RE43510000 -STD RE43510040 -0,40 RE43510050 -0,50</p> <p>1,500 (500) Cr P 1,500 (508) P 2,000 (604) Nit S</p>	<p>ø30,0 x 67,0</p>			
<p>ø85,00</p> <p>4 Cyl. Diesel 1997/1998 cc 79/80/81/100Kw 90/107/109Ps 110/136 Ps DW10ATED TD10ATED DW10TD Euro 3 G6DB RHS RHW RHX RHY RHZ D420 4T</p> <p><u>1998 -</u></p> <p><i>2.0 HDI 206/306/307/406 Boxer Partner Expet C5 Jumpy Xsara Scudo 2.0JTD Cmax Focus II Grand Vitara C30 C70 S40/80 II V50 V70 III TDI</i></p>	<p>18-7550900 STD -mm 18-7550900-20 STD -mm (0.2 mm SHORT) 18-7550903 0,50 mm 18-7550904 0,60 mm</p>	<p>A = 46,750 B = 80,750 C = 18,300 E = -1,000 CD= 38,000</p> <p>Ring Carrier Oil Cut-Out</p>	<p>RE47440000 -STD RE47440060 -0,60</p> <p>3,500 (505) Cr P 2,000 (501) P IFU 3,000 (604) Cr P</p>	<p>ø28,0 x 70,0</p>			<p>1,25 mm Gasket +0,55 + 0,60</p> <p>1,30 mm Gasket +0,61 +0,65</p> <p>1,35 mm Gasket +0,66 +0,70</p> <p>1,40 mm Gasket +0,71 +0,75</p>

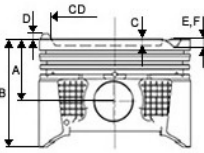
Engine	Ref. No. - Kit 1	Dimensions	Rings	Pin	Piston Liner	Kit 2	Info
<p>ø84,00</p> <p>R 4 Petrol 1995 cm³ 88 kW (120 hp) 9 8:1 M601 AA 20.0, <u>1985-1990</u> Croma</p>  	<p>14-2010450 STD -mm</p>	<p>A = 39,650 B = 79,150 E = -4,500 F = -5,000</p>	<p>RE22230000 -STD RE22230040 -0,40 RE22230060 -0,60 RE22230080 -0,80</p> <p>1,500 (500) CrB Fe S IF 2,000 (508) P 3,947 (605) P</p>	<p>ø22,0 x 69,0</p>			
<p>ø84,00</p> <p>R 4 Petrol 1585 cm³ 55 kW (75 hp) 9 2:1 131AB.IA.0 <u>1974-1981</u> 131</p>  	<p>18-2010600 STD -mm 18-2010602 0,40 mm 18-2010604 0,60 mm 18-2010607 0,80 mm</p>	<p>A = 38,450 B = 77,950</p>	<p>RE22230000 -STD RE22230040 -0,40 RE22230060 -0,60 RE22230080 -0,80</p> <p>1,500 (500) CrB Fe S IF 2,000 (508) P 3,947 (605) P</p>	<p>ø22,0 x 69,1</p>			

							
Engine	Ref. No. - Kit 1	Dimensions	Rings	Pin	Piston Liner	Kit 2	Info
<p>ø84,00</p> <p>R 4 Petrol 1756 cm³ 101 kW (138 hp) 9 9:1 4 VALVES M607 AA/18/0 <u>1974-1982</u> Tipo</p>	<p>14-2010610 STD -mm 14-2010612 0,40 mm</p>	<p>A = 38,800 B = 67,400 D = 0,600 E = -1,000 F = -2,200</p> <p>Oil Cut-Out</p>	<p>RE22230000 -STD RE22230040 -0,40 RE22230060 -0,60 RE22230080 -0,80</p> <p>1,500 (500) CrB Fe S IF 2,000 (508) P 3,947 (605) P</p>	<p>ø22,0 x 63,0</p>			
<p>ø84,00</p> <p>R 4 Petrol 1995 cm³ 151 kW (205 hp) 8:1 M615 HA.20.0 <u>1994</u> Tempra 2,0 16v Tipo 2,0 16v</p>	<p>14-2010680 STD -mm 14-2010682 0,40 mm</p>	<p>A = 39,800 B = 67,800 C = 2,050 E = -2,800 CD= 59,000</p> <p>Steel Support Oil Cut-Out</p>	<p>RE22220000 -STD RE22220040 -0,40 RE22220060 -0,60</p> <p>1,500 (500) CrB Fe S 1,500 (508) P 3,000 (700) NiT S</p>	<p>ø22,0 x 63,0</p>			





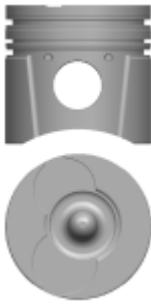
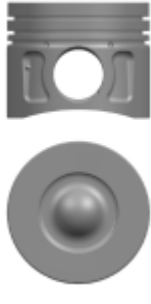



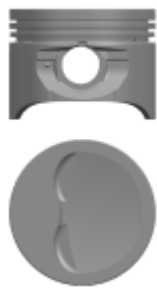



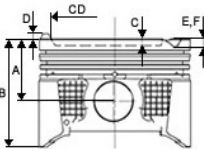





							
Engine	Ref. No. - Kit 1	Dimensions	Rings	Pin	Piston Liner	Kit 2	Info
<p>ø84,00</p> <p>R 4 Petrol 1995 cm³ 151 kW (205 hp) 8:1 M611 LA 20.C025 M601 SA 20.A <u>1990</u> <i>Tempra 2,0 8v</i> <i>Tipo 2,0 8v</i></p>	<p>14-2010690 STD -mm 14-2010692 0,40 mm</p>	<p>A = 39,800 B = 67,800 C = 1,600 E = -4,600 F = -5,600 CD= 50,800</p> <p>Steel Support Oil Cut-Out</p>	<p>RE22220000 -STD RE22220040 -0,40 RE22220060 -0,60</p> <p>1,500 (500) CrB Fe S 1,500 (508) P 3,000 (700) NiT S</p>	<p>ø22,0 x 63,0</p>			
<p>ø84,00</p> <p>R 4 Gasoline1796cc 49 51kW(69 PS) 7,5:1,8 VentileC25 1.8 169 (XM7T) <u>07/87-02/94</u> <i>C25 1.8 E</i> <i>C25 1.8E7/87-2/94</i> <i>DUCATO 1.8</i> <i>1/82-10/88</i> <i>504 1.8</i> <i>1/71-12/89</i> <i>505 1.8</i> <i>6/81-10/85</i> <i>J5 1.8 1/83-11/88</i> <i>7/70-3/80</i></p>	<p>14-7510020 STD -mm</p>	<p>A = 37,800 B = 70,250</p>	<p>RE22280000 -STD</p> <p>1,500 (500) Cr S IF 2,000 (508) P 4,000 (700) Cr P S</p>	<p>ø23,0 x 70,0</p>			

Engine	Ref. No. - Kit 1	Dimensions	Rings	Pin	Piston Liner	Kit 2	Info
<p>ø85,00</p> <p>4 Cyl. Diesel 1997/1998 cc 79/80/81/100Kw 90/107/109Ps 110/136 Ps DW10ATED TD10ATED DW10TD Euro 3 G6DB RHS RHW RHX RHY RHZ D420 4T</p> <p><u>1998 -</u></p> <p>2.0 HDI 206/306/307/406 Boxer Partner Expet C5 Jumpy Xsara Scudo 2.0JTD Cmax Focus II Grand Vitara C30 C70 S40/80 II V50 V70 III TDI</p>	<p>18-7550900 STD -mm 18-7550900-20 STD -mm (0.2 mm SHORT)</p> <p>18-7550903 0,50 mm 18-7550904 0,60 mm</p> 	<p>A = 46,750 B = 80,750 C = 18,300 E = -1,000 CD= 38,000</p> <p>Ring Carrier Oil Cut-Out</p>	<p>RE47440000 -STD RE47440060 -0,60</p> <p>3,500 (505) Cr P 2,000 (501) P IFU 3,000 (604) Cr P</p>	<p>ø28,0 x 70,0</p>		<p>1,25 mm Gasket +0,55 + 0,60</p> <p>1,30 mm Gasket +0,61 +0,65</p> <p>1,35 mm Gasket +0,66 +0,70</p> <p>1,40 mm Gasket +0,71 +0,75</p>	
<p>ø86,01</p> <p>4 Cyl. Diesel 2198 cc 100/120/130 Ps 17,5:1 QWFB/V347 Duratorq Euro 4 Duratorq/V347 D</p> <p><u>2003/2008..</u></p> <p>Common Rail Transit 2.2 TDCI Yeni Jumper 2.2 HDI Ducato 100 Multijet Yeni Boxer HDI</p>	<p>18-2582350 STD -mm 18-2582350-20 STD -mm (0.2 mm SHORT)</p> <p>18-2582351 0,25 mm 18-2582353 0,50 mm 18-2582353-20 0,50 mm (0.2 mm SHORT)</p> 	<p>A = 43,420 B = 69,820 C = 15,850 CD= 46,900</p> <p>Ring Carrier Oil Gallery</p>	<p>RE23350000 -STD RE23350025 -0,25 RE23350050 -0,50</p> <p>2,000 (500) Cr P IF 2,000 (508) P 2,000 (604) Nit S</p>	<p>ø30,0 x 66,9</p>		<p>1,10 mm Gasket +0,38 +0,47</p> <p>1,20 mm Gasket +0,48 +0,58</p> <p>1,30 mm Gasket + 0,59 +0,68</p>	

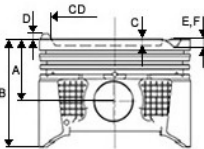
Engine	Ref. No. - Kit 1	Dimensions	Rings	Pin	Piston Liner	Kit 2	Info
<p>ø86,40</p> <p>4 Cyl. Gasoline 1581 cc M202PA.15/A <u>1990-1993</u> Şahin S</p>	<p>18-2010850 STD -mm 18-2010852 0,40 mm 18-2010854 0,60 mm</p>	<p>A = 33,300 B = 65,300 C = 2,800 CD= 71,000</p>	<p>RE22300000 -STD RE22300040 -0,40 RE22300060 -0,60</p> <p>1,500 (500) CrB Fe S 1,750 (508) P 3,000 (700) Cr P S</p>	<p>ø22,0 x 63,2</p>			
<p>ø86,40</p> <p>4 Cyl. Gasoline 1581 cc 72 Kw (96 Ps) M202PB.15.A <u>1990-....</u> Tempra 1.6 SX Tipo 1.6 Punto 1.6 Scudo 1.6</p>	<p>18-2010860 STD -mm 18-2010862 0,40 mm 18-2010864 0,60 mm</p>	<p>A = 33,300 B = 65,300 C = 2,300 E = -3,200 CD= 71,000</p>	<p>RE22300000 -STD RE22300040 -0,40 RE22300060 -0,60</p> <p>1,500 (500) CrB Fe S 1,750 (508) P 3,000 (700) Cr P S</p>	<p>ø22,0 x 63,2</p>			



							
Engine	Ref. No. - Kit 1	Dimensions	Rings	Pin	Piston Liner	Kit 2	Info
<p>ø86,40</p> <p>4 Cyl. Gasoline 1581 cc 103 Ps 182B6000 <u>1998-...</u></p> <p><i>Brava 1,6 16v</i> <i>Marea 1,6 16v</i> <i>Albea 1,6 16v</i></p> 	<p>18-2010870 STD -mm 18-2010872 0,40 mm 18-2010874 0,60 mm</p>	<p>A = 34,170 B = 59,430 E = -2,200 F = -2,800</p>	<p>RE22590000 -STD RE22590040 -0,40 RE22590060 -0,60</p> <p>1,500 (500) Cr P IW 1,500 (501) P IWU 3,000 (700) Cr P S</p>	<p>ø22,0 x 56,0</p>			
<p>ø86,40</p> <p>R 4 Petrol 1581 cm³ 76 kW (103 hp) 10 5:1 4 Valves 182 A.4 000 Euro 2 <u>... 02/1999</u></p> <p><i>Brava 1,6 16v</i> <i>Marea 1,6 16v</i> <i>Bravo 1,6 16v</i></p>	<p>14-2010880 STD -mm 14-2010882 0,40 mm</p>	<p>A = 34,170 B = 56,170 C = 0,530 E = -2,000 CD= 65,000</p>	<p>RE22590000 -STD RE22590040 -0,40 RE22590060 -0,60</p> <p>1,500 (500) Cr P IW 1,500 (501) P IWU 3,000 (700) Cr P S</p>	<p>ø22,0 x 56,0</p>			

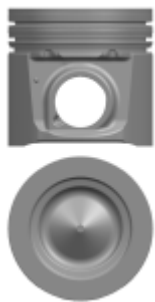

							
Engine	Ref. No. - Kit 1	Dimensions	Rings	Pin	Piston Liner	Kit 2	Info
<p>ø88,00</p> <p>4 Cyl. Diesel 2286 cc 81 KW (120 PS) F1AE0481D EURO 4 <u>2002-....</u></p> <p><i>Ducato Multijet (Box 120 2,3 D Bus 120 2,3 D Platform/Chassis 120M)</i></p>	<p>18-2051330 STD -mm <i>18-2051330-20 STD -mm (0.2 mm SHORT)</i></p> <p>18-2051334 0,60 mm <i>18-2051334-20 0,60 mm (0.2 mm SHORT)</i></p>	<p>A = 57,000 B = 84,000 C = 13,750 CD= 50,100</p> <p>Ring Carrier Oil Gallery Oil Cut-Out</p>	<p>RE22910000 -STD RE22910040 -0,40 RE22910060 -0,60</p> <p>2,500 (504) Cr 2,000 (501) P IF 2,500 (604) Cr P</p>	<p>ø31,0 x 67,0</p>			
<p>ø93,00</p> <p>4 Cyl. Diesel 2499 cc 63 Kw (83 Ps) 8140.67 <u>1994-....</u></p> <p><i>Sofim Doğal Emişli Ducato 2.5 D</i></p>	<p>18-2051350 STD -mm 18-2051352 0,40 mm</p>	<p>A = 54,000 B = 89,000 C = 2,200</p> <p>Ring Carrier Hard Anodising Oil Cut-Out</p>	<p>RE22340000 -STD RE22340040 -0,40 RE22340060 -0,60</p> <p>3,000 (504) Cr P 2,000 (501) P 3,000 (604) Cr P</p>	<p>ø32,0 x 75,2</p>			<p>1,60 mm Gasket</p> <p>+ 0,75 + 0,81 1,80 mm Gasket</p> <p>+ 0,82 + 1,14</p>

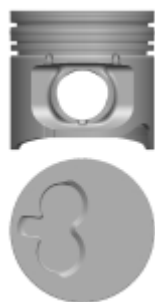

Engine	Ref. No. - Kit 1	Dimensions	Rings	Pin	Piston Liner	Kit 2	Info
<p>ø93,00</p> <p>4 Cyl. Diesel 2499 cc 62 Kw (85 Ps) Atmospheric SOFIM 2/5 Düz <u>2001 -....</u></p> <p><i>Ducato 2.5 D</i> <i>Movano 2.5 D</i> <i>Master 2.5 D</i></p>	<p>18-3051880 STD -mm <i>18-3051880-20 STD -mm</i> <i>(0.2 mm SHORT)</i></p> <p>18-3051882 0,40 mm <i>18-3051882-20 0,40 mm</i> <i>(0.2 mm SHORT)</i></p>	<p>A = 54,000 B = 89,000 C = 2,200</p> <p>Ring Carrier Hard Anodising Oil Cut-Out</p>	<p>RE22340000 -STD RE22340040 -0,40 RE22340060 -0,60</p> <p>3,000 (504) Cr P 2,000 (501) P 3,000 (604) Cr P</p>	<p>ø32,0 x 68,0</p>			<p>+0,40 +0,50 1.20 mm Gasket</p> <p>+0,51 +0,60 1.30 mm Gasket</p> <p>+0,61 +0,70 1.40 mm Gasket</p>
<p>ø94,40</p> <p>4 Cyl. Diesel 2798 cc 64 Kw (87 Ps) Sofim Motor 8140.63.3700 <u>1998 - 1999</u></p> <p><i>Ducato 14 2.8 D</i> <i>Ducato Maxi 2.8D</i></p>	<p>18-2051130 STD -mm 18-2051132 0,40 mm 18-2051134 0,60 mm</p>	<p>A = 55,000 B = 90,000 C = 1,700</p> <p>Ring Carrier Hard Anodising Oil Cut-Out</p>	<p>RE22790000 -STD RE22790040 -0,40 RE22790060 -0,60</p> <p>3,000 (504) Cr P 2,000 (501) P IWU 2,500 (604) Cr P</p>	<p>ø32,0 x 68,0</p>			<p>+ 0,40 + 0,50 (1.20 mm Gasket)</p> <p>+ 0,51 + 0,60 (1.30 mm Gasket)</p> <p>+ 0,61 + 0,70 (1.40 mm Gasket)</p>

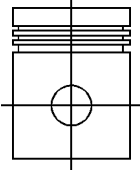







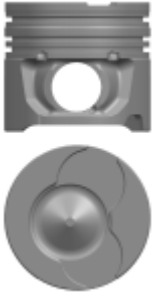
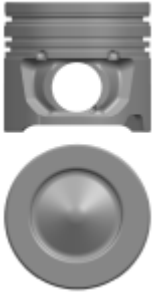

Engine	Ref. No. - Kit 1	Dimensions	Rings	Pin	Piston Liner	Kit 2	Info
<p>ø94,40</p> <p>4 Cyl. Diesel 2798 cc 107 Kw (146 Ps) 18 5:1 SOFIM 8140.43S.4000 Euro 3 8140.23.2585/3700 Euro 3 8140.63.3700 8140.43M. 4300/4320/4330 Euro 3</p> <p><u>2000-....</u></p> <p><i>Ducato 2.8 JTD (35C.15/35S.15/50C.15 60C.15 TD/65C.15 65C.13 Daily Unijet) Boxer 2.8 HDI</i></p> 	<p>18-2081440 STD -mm 18-2081442 0,40 mm 18-2081444 0,60 mm</p>	<p>A = 58,700 B = 87,600 C = 21,300 CD= 39,500</p> <p>Ring Carrier Oil Gallery Oil Cut-Out</p>	<p>RE22780000 -STD RE22780040 -0,40 RE22780060 -0,60</p> <p>2,500 (504) Cr P 2,000 (501) P 2,500 (604) Cr P</p>	<p>ø32,0 x 72,0</p>			<p>1,20 mm Gasket</p> <p>+ 0,40 + 0,50 1,30 mm Gasket</p> <p>+ 0,51 + 0,60 1,40 mm Gasket</p> <p>+ 0,61 + 0,70 1,50 mm Gasket</p> <p>+ 0,71 + 0,80</p>
<p>ø94,40</p> <p>4 Cyl. Diesel 2800 cc 76 Kw (103 Ps) 18 5:1 8140.23.2585 8140.43.2585 Motor No: > 2572279</p> <p><u>1996 - 1999</u></p> <p><i>35.10, 49.10 M14 Minibus Turbo Daily</i></p>	<p>14-2081550 STD -mm 14-2081552 0,40 mm 14-2081554 0,60 mm</p>	<p>A = 58,750 B = 96,750 C = 19,400 CD= 39,400</p> <p>Ring Carrier Oil Gallery Oil Cut-Out</p>	<p>RE22560000 -STD RE22560040 -0,40 RE22560060 -0,60</p> <p>3,000 (504) Cr P 2,000 (501) P IWU 3,000 (604) Cr P</p>	<p>ø32,0 x 78,1</p>			<p>1,20 mm Gasket</p> <p>+ 0,40 + 0,50 1,30 mm Gasket</p> <p>+ 0,51 + 0,60 1,40 mm Gasket</p> <p>+ 0,61 + 0,70 1,50 mm Gasket</p> <p>+ 0,71 + 0,80</p>



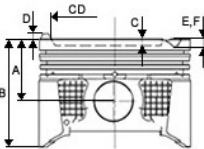





Engine	Ref. No. - Kit 1	Dimensions	Rings	Pin	Piston Liner	Kit 2	Info
<p>ø68,70</p> <p>R 4 Petrol, 1119 cm³ 40 kW (55 hp) GUD GUE</p> <p><u>1989-1992</u></p> <p><i>Fiesta Escort</i></p>	<p>14-2510750 STD -mm 14-2510753 0,50 mm 14-2510758 1,00 mm</p> 	<p>A = 29,400 B = 53,900</p>	<p>RE23000000 -STD RE23000050 -0,50 RE23000100 -1,00</p> <p>1,500 (500) Cr S 1,750 (508) P 3,000 (700) Cr P S</p>	<p>ø18,0 x 59,0</p>			
<p>ø68,70</p> <p>R 4 Petrol, 1119 cm³ 37 kW (50 hp) GUF G 6 A</p> <p><u>1989-1996</u></p> <p><i>Fiesta III 1.1</i></p>	<p>14-2510760 STD -mm 14-2510763 0,50 mm 14-2510768 1,00 mm</p> 	<p>A = 29,400 B = 53,900 C = 3,500 CD= 36,000</p>	<p>RE23000000 -STD RE23000050 -0,50 RE23000100 -1,00</p> <p>1,500 (500) Cr S 1,750 (508) P 3,000 (700) Cr P S</p>	<p>ø18,0 x 59,0</p>			

Engine	Ref. No. - Kit 1	Dimensions	Rings	Pin	Piston Liner	Kit 2	Info
<p>ø71,91</p> <p>R 4 Petrol, 1242 cm³ 55 kW (75 hp) ZtecS DHA DHB DHC DHD DHE DHF DHG <u>1997-2001</u> Fiesta 1.2 16v Focus 1.2 16v Mazda 121</p>	<p>18-2510860 STD -mm 18-2510863 0,50 mm</p>	<p>A = 28,250 B = 53,250 C = 0,930 CD= 52,000</p>	<p>RE23480000 -STD RE23480050 -0,50</p> <p>1,200 (500) CrB P S IF 1,500 (508) P 2,500 (700) Cr P S</p>	<p>ø19,0 x 50,0</p>			
<p>ø73,50</p> <p>4 Cyl. Diesel 1498 cc 55 KW 75 PS 1.5L Duratorq Euro5 <u>2013 -</u> B-Max C-Max Fiesta Focus</p>	<p>18-2592120 STD -mm 18-2592123 0,50 mm</p>	<p>A = 41,700 B = 65,200 C = 13,400 CD= 45,000</p> <p>Ring Carrier Oil Gallery Oil Cut-Out</p>	<p>RE23660000 -STD RE23660050 -0,50</p> <p>2,000 (xxx) CK 1,950 (xxx) P 2,000 (xxx) CR</p>				

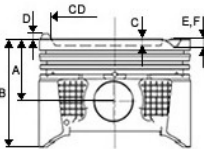







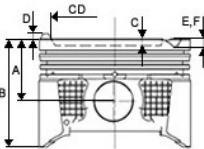

Engine	Ref. No. - Kit 1	Dimensions	Rings	Pin	Piston Liner	Kit 2	Info
<p>ø73,70</p> <p>4 Cyl. Diesel 1399 cc 50 Kw (68 Ps) DV4TD DV4 TED DV4C TED F6JA F6JB 8HX 8HR 8HZ 8HS</p> <p><u>2002 -....</u></p> <p><i>Fiesta V 1.4 TDCI Fusion 1.4 TDCI Mazda 2 1,4D C2 1.4 HDI C3 I 1.4 HDI XSARA 1.4 HDI NEMO 1.4 HDI 1007 1.4 HDI 107 1.4 HDI 206 1.4 HDI 207 1.4 HDI 307 1.4 HDI BIPPER 1.4 HDI</i></p> 	<p>18-2550150 STD -mm <i>18-2550150-20 STD -mm (0.2 mm SHORT)</i> 18-2550153 0,50 mm <i>18-2550153-20 0,50 mm (0.2 mm SHORT)</i> <i>18-2550153-40 0,50 mm (0.4 mm SHORT)</i></p>	<p>A = 42,940 B = 65,440 C = 14,700 CD= 37,200</p> <p>Ring Carrier</p>	<p>RE23050000 -STD RE23050050 -0,50</p> <p>2,500 (505) CrB P 1,950 (508) P IFU 2,500 (604) Cr P</p>	<p>ø25,0 x 60,0</p>			
<p>ø73,70</p> <p>4 Cyl. Diesel 1398cc 68 HP 50 KW DV4C Euro 5</p> <p><u>2010 -....</u></p> <p><i>Fiesta V 1.4 TDCI</i></p> 	<p>18-2550160 STD -mm 18-2550163 0,50 mm</p>	<p>A = 42,900 B = 65,400 C = 12,500 CD= 45,100</p> <p>Ring Carrier Oil Cut-Out</p>	<p>RE23580000 -STD RE23580050 -0,50</p> <p>2,500 (514) Cr P 1,950 (508) P IFU 2,000 (604) Nit S</p>	<p>ø25,0 x 60,0</p>			

							
Engine	Ref. No. - Kit 1	Dimensions	Rings	Pin	Piston Liner	Kit 2	Info
<p>ø73,94</p> <p>R 4 Petrol, 935 cm³ 29 kW (40 hp), 8,3:1 1000TK B LC CR <u>1976-1983</u></p> <p><i>Fiesta L GL Popular</i></p>	<p>14-2510120 STD -mm</p>	<p>A = 38,400 B = 64,400</p>	<p>RE23020000 -STD RE23020050 -0,50 RE23020100 -1,00</p> <p>1,600 (500) Cr 2,000 (508) P 4,000 (700) Cr Cr P S</p>	<p>ø20,6 x 63,5</p>			
<p>ø73,94</p> <p>R 4 Petrol, 1297 cm³ 44 kW (60 hp), 9,3:1 JLA (BL13H) <u>1985-1988</u></p> <p><i>Escort 1300 Combi Van Orion 1300 L</i></p>	<p>14-2510700 STD -mm</p>	<p>A = 39,130 B = 65,130 C = 3,270 CD= 41,500</p>	<p>RE23020000 -STD RE23020050 -0,50 RE23020100 -1,00</p> <p>1,600 (500) Cr 2,000 (508) P 4,000 (700) Cr Cr P S</p>	<p>ø20,6 x 63,5</p>			







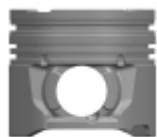

							
Engine	Ref. No. - Kit 1	Dimensions	Rings	Pin	Piston Liner	Kit 2	Info
<p>ø73,94</p> <p>R 4 Petrol, 1297 cm³ 44 kW (60 hp)</p> <p>J4C J4D J4J J4K J4L J4M J4N J4P J4Q J4R J4S J4T JB</p> <p><u>1988-1992</u></p> <p><i>Escort IV 1.3</i> <i>Fiesta IV 1.3</i></p> 	<p>18-2510770 STD -mm 18-2510773 0,50 mm 18-2510778 1,00 mm</p>	<p>A = 29,400 B = 53,900</p>	<p>RE23010000 -STD RE23010050 -0,50 RE23010100 -1,00</p> <p>1,500 (500) Cr S IF 1,750 (508) P 3,000 (700) Cr P S</p>	<p>ø18,0 x 64,0</p>			
<p>ø73,94</p> <p>R 4 Petrol, 1297 cm³ 44 kW (60 hp)</p> <p>J4B J6A J6B JBC JBE</p> <p><u>1992 -....</u></p> <p><i>Fiesta III 1.3</i> <i>Escort V 1.3</i> <i>Orion III 1.3 I</i></p>	<p>14-2510850 STD -mm 14-2510853 0,50 mm 14-2510858 1,00 mm</p>	<p>A = 29,400 B = 53,900 C = 3,500 CD= 38,000</p>	<p>RE23010000 -STD RE23010050 -0,50 RE23010100 -1,00</p> <p>1,500 (500) Cr S IF 1,750 (508) P 3,000 (700) Cr P S</p>	<p>ø18,0 x 64,0</p>			

Engine	Ref. No. - Kit 1	Dimensions	Rings	Pin	Piston Liner	Kit 2	Info
<p>ø73,94</p> <p>R 4 Petrol, 1297 cm³ 44 kW (60 hp) J4B J6A J6B JBC JBE <u>1992 -....</u></p> <p><i>Fiesta III 1.3 Escort V 1.3 Orion III 1.3 I</i></p>	<p>14-2510850 STD -mm 14-2510853 0,50 mm 14-2510858 1,00 mm</p>	<p>A = 29,400 B = 53,900 C = 3,500 CD= 38,000</p>	<p>RE23010000 -STD RE23010050 -0,50 RE23010100 -1,00</p> <p>1,500 (500) Cr S IF 1,750 (508) P 3,000 (700) Cr P S</p>	<p>ø18,0 x 64,0</p>			
<p>ø75,00</p> <p>4 Cyl. Diesel 1560cc 70 Kw (95 Ps) 1.6 HDi (DV6C) EUR5 1.6 HDi (DV6D) Euro 4 <u>2011 -....</u></p> <p><i>FOCUS BERLINGO 1.6 8V C4 (B7) DS4 (9HR-9HL) DS5 Grand Picasso II C4 DS4 DS3 C3 C3 II 3008 308 5008 508 Partner Tepee 2008 308 SW 207 SW 208 207</i></p>	<p>18-2581660 STD -mm 18-2581660-20 STD -mm (0.2 mm SHORT) 18-2581660-40 STD -mm (0.4 mm SHORT) 18-2581663 0,50 mm 18-2581663-20 0,50 mm (0.2 mm SHORT) 18-2581663-40 0,50 mm (0.4 mm SHORT)</p>	<p>A = 41,750 B = 65,200 C = 13,850 CD= 45,000</p> <p>Ring Carrier Oil Gallery Oil Cut-Out</p>	<p>RE23550000 -STD RE23550050 -0,50</p> <p>2,500 (514) Cr P 1,950 (508) P 2,000 (604) Nit S</p>	<p>ø26,0 x 61,0</p>			<p>1 Notch 0,5 mm 0,63 mm</p> <p>2 Notch 0,63 mm 0,68 mm</p> <p>3 Notch 0,68 mm 0,73 mm</p> <p>4 Notch 0,73 mm 0,78 mm</p> <p>5 Notch 0,78 mm 0,88 mm</p>

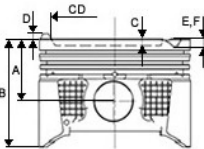





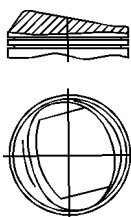

							
Engine	Ref. No. - Kit 1	Dimensions	Rings	Pin	Piston Liner	Kit 2	Info
<p>ø75,00</p> <p>4 Cyl. Diesel 1560 cc 80 Kw (109 Ps) DV6TD/TED</p> <p><u>2004 -....</u></p> <p><i>Expert 1,6 HDI 307 1,6 HDI 206 1,6 HDI C4 1,6 HDI Jumpy 1,6 HDI C-Max 1,6 HDI Focus 1,6 HDI</i></p>	<p>18-2591770 STD -mm <i>18-2591770-20 STD -mm (0.2 mm SHORT)</i></p> <p>18-2591770-40 STD -mm <i>(0.4 mm SHORT)</i></p> <p>18-2591773 0,50 mm <i>18-2591773-20 0,50 mm (0.2 mm SHORT)</i></p> <p><i>18-2591773-40 0,50 mm (0.4 mm SHORT)</i></p> <p>18-2591774 0,60 mm <i>18-2591774-20 0,60 mm (0.2 mm SHORT)</i></p> <p><i>18-2591774-40 0,60 mm (0.4 mm SHORT)</i></p>	<p>A = 41,700 B = 65,300 C = 13,250 E = -1,200 CD= 41,800</p> <p>Ring Carrier Oil Gallery Oil Cut-Out</p>	<p>RE47460000 -STD RE47460040 -0,40 RE47460050 -0,50 RE47460060 -0,60</p> <p>3,000 (505) CKP 1,950 (508) P 2,500 (604) CrP</p>	<p>ø26,0 x 61,0</p>		<p>1.35 mm Gasket +0,68 +0,73</p> <p>1.25 mm Gasket +0,53 +0,63</p> <p>1.30 mm Gasket +0,63 +0,68</p> <p>1.40 mm Gasket +0,73 +0,78</p> <p>1.45 mm Gasket +0,78 +0,88</p>	
<p>ø76,00</p> <p>4 Cyl. Gasoline 1597 cc 65 Kw (89 P) ZH16 ZETEC E</p> <p>L1E L1F L1G L1H L1J L1K L1L L1N L1Q LUH LUJ</p> <p><u>1992 -....</u></p> <p><i>Escort Fiesta Mendoso Orion</i></p>	<p>18-2510800 STD -mm <i>18-2510803 0,50 mm</i> <i>18-2510808 1,00 mm</i></p>	<p>A = 32,650 B = 58,350 D = 1,700 CD= 61,400</p> <p>Steel Support</p>	<p>RE23030000 -STD RE23030050 -0,50 RE23030100 -1,00</p> <p>1,500 (500) CrB Fe S 1,600 (508) P 2,500 (700) Cr P S</p>	<p>ø20,6 x 63,5</p>			

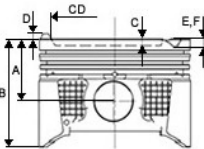

Engine	Ref. No. - Kit 1	Dimensions	Rings	Pin	Piston Liner	Kit 2	Info
<p>ø76,00</p> <p>4 Cyl. Gasoline 1400cc 80 Ps FXDA FXDB FXDC FXJA FXJB</p> <p><u>2002 - 2011</u></p> <p><i>Fiesta 1.4 Puma 1.4 Mazda 2 1,4i 16v Mazda 3 1,4i 16v</i></p> <div data-bbox="335 846 488 1126" style="text-align: center;"> </div>	<p>18-2510870 STD -mm 18-2510873 0,50 mm</p>	<p>A = 28,250 B = 55,500 D = 1,250</p>	<p>RE23540000 -STD RE23540050 -0,50</p> <p>1,200 (500) NitB S 1,500 (501) P 2,500 (700) Nit S</p>	<p>ø19,0 x 50,0</p>			
<p>ø76,01</p> <p>4 Cyl. Gasoline 1388cc 66 Kw (90 Ps)10.3:1 FHF Zetec SE DOHC 16V EFi ZH14</p> <p><u>1997 -2010..</u></p> <p><i>Fiesta 1.4 Puma 1.4 16V</i></p> <div data-bbox="335 1711 488 1991" style="text-align: center;"> </div>	<p>14-2510880 STD -mm 14-2510883 0,50 mm</p>	<p>A = 32,650 B = 58,350 D = 1,700 CD= 61,400</p>	<p>RE23030000 -STD RE23030050 -0,50 RE23030100 -1,00</p> <p>1,500 (500) CrB Fe S 1,600 (508) P 2,500 (700) Cr P S</p>	<p>ø20,6 x 63,4</p>			

							
Engine	Ref. No. - Kit 1	Dimensions	Rings	Pin	Piston Liner	Kit 2	Info
<p>ø77,25</p> <p>R 4 Petrol, 1396 cm³ 54 55 kW (73 75 hp), 9,5:1 1.4 CVH FUA CR <u>1985-1992</u> <i>Fiesta Escort Orion</i></p>	<p>14-2510670 STD -mm</p>	<p>A = 39,200 B = 75,000 D = 5,800</p>	<p>RE23020000 -STD RE23020050 -0,50 RE23020100 -1,00</p> <p>1,600 (500) Cr 2,000 (508) P 4,000 (700) Cr Cr P S</p>	<p>ø20,6 x 63,5</p>			
<p>ø77,25</p> <p>R 4 Petrol, 1392 cm³ 44 54,5 kW (60 74 hp) 1. Lit. (CAT) CR <u>1984-....</u> <i>Escort IV 1.3 Fiesta IV 1.3 Orion</i></p>	<p>14-2510790 STD -mm</p>	<p>A = 39,200 B = 71,900 D = 2,700</p>	<p>RE23020000 -STD RE23020050 -0,50 RE23020100 -1,00</p> <p>1,600 (500) Cr 2,000 (508) P 4,000 (700) Cr Cr P S</p>	<p>ø20,6 x 63,5</p>			



							
Engine	Ref. No. - Kit 1	Dimensions	Rings	Pin	Piston Liner	Kit 2	Info
<p>ø79,00</p> <p>4 Cyl. Gasoline 1600 cc</p> <p>1.6 Ecoboost</p> <p>..... -</p> <p>1.6 EcoBoost</p>	<p>18-2510440 STD -mm 18-2510440-20 STD -mm (0.2 mm SHORT)</p> <p>18-2510443 0,50 mm 18-2510443-20 0,50 mm (0.2 mm SHORT)</p>	<p>A = 28,300 B = 54,200 C = 5,000 CD= 53,500</p> <p>Hard Anodising</p>	<p>RE43490000 -STD RE43490050 -0,50 RE43490100 -1,00</p> <p>1,200 (500) NitB S 1,200 (501) P 2,000 (700) Cr P S</p>	<p>ø21,0 x 46,0</p>			
<p>ø79,00</p> <p>4 Cyl. Gasoline 1600cc 115 123 PS 1.6 ZETEC S</p> <p><u>2007 -</u></p> <p>Focus Mondeo</p>	<p>18-2510470 STD -mm 18-2510473 0,50 mm</p>	<p>A = 25,400 B = 53,400 C = 0,700 E = -3,800 F = -2,760 CD= 50,900</p>	<p>RE23080000 -STD RE23080050 -0,50</p> <p>1,200 (500) NitB S 1,500 (508) P 2,000 (700) Nit S</p>	<p>ø18,0 x 54,0</p>			

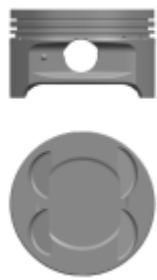
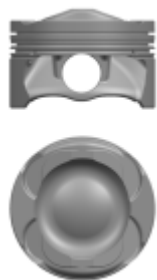

Engine	Ref. No. - Kit 1	Dimensions	Rings	Pin	Piston Liner	Kit 2	Info
<p>ø79,00</p> <p>4 Cyl. Gasoline 1596cc 100 115 PS C MAX 1.6 <u>2003 -</u> Focus 1,6i 16v</p>	<p>18-2510480 STD -mm 18-2510483 0,50 mm</p>	<p>A = 25,050 B = 48,050 C = 0,650 CD= 57,300</p>	<p>RE23080000 -STD RE23080050 -0,50</p> <p>1,200 (500) NitB S 1,500 (508) P 2,000 (700) Nit S</p>	<p>ø18,0 x 50,9</p>			
<p>ø79,00</p> <p>4 Cyl. Gasoline 1597 cc 73 Kw (99 Ps) ZH16 Zetec s DOHC 16V EFi <u>1998 -</u> Focus Ghia LX 16v</p>	<p>18-2510890 STD -mm 18-2510890-20 STD -mm (0.2 mm SHORT) 18-2510893 0,50 mm 18-2510893-20 0,50 mm (0.2 mm SHORT)</p>	<p>A = 25,050 B = 48,100</p>	<p>RE23080000 -STD RE23080050 -0,50</p> <p>1,200 (500) NitB S 1,500 (508) P 2,000 (700) Nit S</p>	<p>ø18,0 x 50,9</p>			<p>- 1,40 - 1,60</p>



Engine	Ref. No. - Kit 1	Dimensions	Rings	Pin	Piston Liner	Kit 2	Info
<p>ø79,97</p> <p>4 Cyl. Gasoline 1598 cc 66/70 Kw (90/95 Ps) CVH LUC <u>1985 - 1992</u></p> <p><i>Escort 1.6</i> <i>Fiesta XR2</i> <i>Orion</i> <i>1985-1992</i></p>	<p>18-2510710 STD -mm 18-2510713 0,50 mm 18-2510718 0,50 mm</p>	<p>A = 36,590 B = 66,590 CD= 7,120</p> <p>Steel Support</p>	<p>RE23090000 -STD RE23090050 -0,50 RE23090100 -0,50</p> <p>1,600 (500) Cr 2,000 (508) P 4,000 (700) Cr P S</p>	<p>ø20,6 x 66,7</p>			
<p>ø80,00</p> <p>4 Cyl. Diesel 1608 cc 39,5 Kw (54 Ps) 21,5:1 LTA LTB LTC D16 <u>1998 -</u></p> <p><i>Fiesta D</i> <i>Escort D</i> <i>Orion D</i></p>	<p>14-2550900 STD -mm 14-2550903 0,50 mm</p>	<p>A = 46,700 B = 76,700 C = 1,800 E = -0,010</p>	<p>RE23100000 -STD RE23100050 -0,50 RE23100100 -1,00</p> <p>2,000 (500) CrB Fe S 2,000 (501) P 3,000 (604) Cr P</p>	<p>ø24,0 x 62,0</p>			<p>1 Notch Gasket +0,43 +0,62</p> <p>2 Notch Gasket +0,62 +0,68</p> <p>3 Notch Gasket +0,68 +0,74</p> <p>4 Notch Gasket +0,74 +0,80</p> <p>5 Notch Gasket +0,80 +0,86</p>



Engine	Ref. No. - Kit 1	Dimensions	Rings	Pin	Piston Liner	Kit 2	Info
<p>ø80,60</p> <p>4 Cyl. Gasoline 1796 cc 103/113 P ZH 1.8 ZETEC <u>1994 -....</u></p> <p><i>Mondeo I 1.8 Escort V 1.8 Fiesta III 1.8 I Orion III 1.8 I</i></p>	<p>18-2510810 STD -mm 18-2510813 0,50 mm 18-2510818 1,00 mm</p>	<p>A = 33,050 B = 57,100</p> <p>Steel Support Oil Cut-Out</p> 	<p>RE23280000 -STD RE23280050 -0,50 RE23280100 -1,00</p> <p>1,500 (500) Cr P IW 1,750 (508) P 3,000 (604) Cr P</p>	<p>ø20,6 x 63,5</p>			
<p>ø81,30</p> <p>R 4 Petrol, 1598 cm³ 55 kW (75 hp) LCR LCS LCT LSD LSE LSF E <u>1986-1992</u></p> <p><i>Sierra 1.6 Laser 1.6</i></p>	<p>14-2510500 STD -mm</p>	<p>A = 41,550 B = 71,550</p>	<p>RE23340000 -STD RE23340050 -0,50 RE23340100 -1,00</p> <p>1,600 (500) Cr P 2,000 (501) P 4,000 (700) Cr P S</p>	<p>ø24,0 x 68,8</p>			

Engine	Ref. No. - Kit 1	Dimensions	Rings	Pin	Piston Liner	Kit 2	Info
<p>ø82,50</p> <p>4 Cyl. Diesel 1753cc 70 Kw (90 Ps) RWPA RWPC RWPD <u>2006..2013</u> <i>Transit Connect 1.8 TDCI</i></p>	<p>18-2550190 STD -mm 18-2550193 0,50 mm</p>	<p>A = 45,650 B = 71,150 C = 12,400 CD= 45,200</p> <p>Ring Carrier</p>	<p>RE23300000 -STD RE23300050 -0,50</p> <p>1,750 (500) Cr S IF 2,000 (508) P IFU 2,000 (604) Nit S</p>	<p>ø28,0 x 66,0</p>			
<p>ø82,50</p> <p>R 4 Diesel, 1758 cm³ 66 85 kW (90 115 hp) F9DA F9DB <u>2001 -....</u> <i>Focus 1.8 TDCI</i></p>	<p>14-2550200 STD -mm 14-2550203 0,50 mm</p>	<p>A = 45,700 B = 70,700 C = 14,050 CD= 41,520</p> <p>Ring Carrier</p>	<p>RE23500000 -STD RE23500050 -0,50 RE23500100 -1,00</p> <p>2,500 (503) Cr S 2,000 (501) P 3,000 (604) Cr P</p>	<p>ø28,0 x 66,0</p>			

Engine	Ref. No. - Kit 1	Dimensions	Rings	Pin	Piston Liner	Kit 2	Info
<p>ø82,50</p> <p>4 Cyl. Diesel 1800 cc 75 Ps C9DA C9DB C9DC <u>2002-....</u> <i>Focus 1,8 TDDi Connect 1,8 TDDi</i></p>	<p>18-2550220 STD -mm 18-2550223 0,50 mm 18-2550228 1,00 mm</p>	<p>A = 45,700 B = 70,900 C = 16,200 CD= 36,750</p> <p>Ring Carrier</p>	<p>RE23500000 -STD RE23500050 -0,50 RE23500100 -1,00</p> <p>2,500 (503) Cr S 2,000 (501) P 3,000 (604) Cr P</p>	<p>ø28,0 x 66,0</p>			<p>1,36 mm Gasket +0,43 +0,68</p> <p>1,42 mm Gasket + 0,68 + 0,74</p> <p>1,52 mm Gasket + 0,74 + 0,86</p>
<p>ø82,50</p> <p>R 4 Diesel, 1753 cm³ 44 kW (60 hp), 21,5:1 RTA RTB RTC RTD RTE RTF RTG RTH RTJ <u>1988-1994</u> <i>Fiesta D Escort D Orion D Mazda 121 1,8D</i></p>	<p>18-2550910 STD -mm 18-2550913 0,50 mm</p>	<p>A = 45,700 B = 73,700 C = 1,600</p> <p>Ring Carrier</p>	<p>RE43150000 -STD RE43150050 -0,50 RE43150100 -1,00</p> <p>2,000 (500) Cr 2,000 (501) P 3,000 (604) Cr</p>	<p>ø26,0 x 69,0</p>			

Engine	Ref. No. - Kit 1	Dimensions	Rings	Pin	Piston Liner	Kit 2	Info
<p>ø82,50</p> <p>R 4 Diesel, 1753 cm³ 65 kW (88 hp)</p> <p>RFA RFB RFD RFK RFL RFM RFN RFS RFU</p> <p><u>1998 -....</u></p> <p>Mondeo Escort Sierra</p>	<p>14-2550920 STD -mm 14-2550923 0,50 mm</p>	<p>A = 45,650 B = 75,800 C = 1,500</p> <p>Ring Carrier</p>	<p>RE23500000 -STD RE23500050 -0,50 RE23500100 -1,00</p> <p>2,500 (503) Cr S 2,000 (501) P 3,000 (604) Cr P</p>	<p>ø26,0 x 69,0</p>			
<p>ø82,50</p> <p>4 Cyl. Diesel 1800 cc 90 Ps ECOTORQ (Cooling Channel) 1.8 TDCi</p> <p><u>2002 -....</u></p> <p>Connect 1,8 TDCi</p>	<p>18-2581880 STD -mm 18-2581883 0,50 mm 18-2581884 0,60 mm 18-2581888 1,00 mm</p>	<p>A = 45,500 B = 70,700 C = 14,100 CD= 41,500</p> <p>Ring Carrier Oil Gallery</p>	<p>RE23500000 -STD RE23500050 -0,50 RE23500100 -1,00</p> <p>2,500 (503) Cr S 2,000 (501) P 3,000 (604) Cr P</p>	<p>ø28,0 x 66,0</p>			<p>1,36 mm Gasket +0,43 +0,68</p> <p>1,42 mm Gasket +0,68 +0,74</p> <p>1,52 mm Gasket +0,74 +0,86</p>

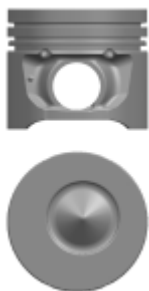

Engine	Ref. No. - Kit 1	Dimensions	Rings	Pin	Piston Liner	Kit 2	Info
<p>ø82,50</p> <p>4 Cyl. Diesel 1753 cc 81 Kw (110 Ps) 18,5:1 KKDA DURATORQ 1800cc <u>2007 -....</u> Connect 1,8 TDCi</p>	<p>18-2582110 STD -mm <i>18-2582110-20 STD -mm (0.2 mm SHORT)</i></p> <p>18-2582113 0,50 mm <i>18-2582113-20 0,50 mm (0.2 mm SHORT)</i></p>	<p>A = 45,650 B = 71,150 C = 12,470 CD= 45,290</p> <p>Ring Carrier Oil Gallery</p>	<p>RE23300000 -STD RE23300050 -0,50</p> <p>1,750 (500) Cr S IF 2,000 (508) P IFU 2,000 (604) Nit S</p>	<p>ø28,0 x 66,0</p>			<p>1,36 mm Gasket +0,43 +0,68</p> <p>1,42 mm Gasket +0,68 +0,74</p> <p>1,52 mm Gasket +0,74 +0,86</p>
<p>ø85,00</p> <p>4 Cyl. Diesel 1997/1998 cc 79/80/81/100Kw 90/107/109Ps 110/136 Ps DW10ATED TD10ATED DW10TD Euro 3 G6DB RHS RHW RHX RHY RHZ D420 4T</p> <p><u>1998 -</u></p> <p>2.0 HDI 206/306/307/406 Boxer Partner Expet C5 Jumpy Xsara Scudo 2.0JTD Cmax Focus II Grand Vitara C30 C70 S40/80 II V50 V70 III TDI</p>	<p>18-7550900 STD -mm <i>18-7550900-20 STD -mm (0.2 mm SHORT)</i></p> <p>18-7550903 0,50 mm 18-7550904 0,60 mm</p>	<p>A = 46,750 B = 80,750 C = 18,300 E = -1,000 CD= 38,000</p> <p>Ring Carrier Oil Cut-Out</p>	<p>RE47440000 -STD RE47440060 -0,60</p> <p>3,500 (505) Cr P 2,000 (501) P IFU 3,000 (604) Cr P</p>	<p>ø28,0 x 70,0</p>			<p>1,25 mm Gasket +0,55 + 0,60</p> <p>1,30 mm Gasket +0,61 +0,65</p> <p>1,35 mm Gasket +0,66 +0,70</p> <p>1,40 mm Gasket +0,71 +0,75</p>

Engine	Ref. No. - Kit 1	Dimensions	Rings	Pin	Piston Liner	Kit 2	Info
<p>ø85,00</p> <p>R 4 Diesel, 1997 cm³ 62 88 kW (84 120 PS) DW10BTED4 <u>1999 - 2007</u></p> <p><i>(2.0HDI)</i> Berlingo C4 16V C4 GrandPicasso 16V C4 Picasso 16V C5 16V C8 16V Jumpy 6V C-Max Kuga 307 16V 307 CC 16V 308 16V 407 16V 508</p>	<p>18-7551920 STD -mm 18-7551924 0,60 mm</p>	<p>A = 46,705 B = 80,705 C = 15,400 E = -0,520 CD= 44,800</p> <p>Ring Carrier Oil Gallery Oil Cut-Out</p>	<p>RE47440000 -STD RE47440060 -0,60</p> <p>3,500 (505) Cr P 2,000 (501) P IFU 3,000 (604) Cr P</p>	<p>ø28,0 x 70,0</p>			
<p>ø84,80</p> <p>4 Cyl. Gasoline 1998 cc 96 100 KW 130 EDDC EDBC EDBA CAA <u>1996 -....</u></p> <p>Mondeo II 2.0 I Focus I 2.0</p>	<p>18-2510820 STD -mm 18-2510823 0,50 mm</p>	<p>A = 32,930 B = 56,930</p>	<p>RE23180000 -STD RE23180050 -0,50</p> <p>1,500 (500) Cr P IF 1,750 (508) P 3,000 (700) Cr S P</p>	<p>ø20,6 x 63,5</p>			

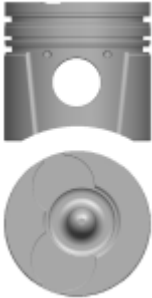
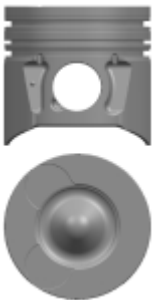
Engine	Ref. No. - Kit 1	Dimensions	Rings	Pin	Piston Liner	Kit 2	Info
<p>ø85,00</p> <p>4 Cyl. Diesel 1997/1998 cc 79/80/81/100Kw 90/107/109Ps 110/136 Ps DW10ATED TD10ATED DW10TD Euro 3 G6DB RHS RHW RHX RHY RHZ D420 4T</p> <p><u>1998 -</u></p> <p>2.0 HDI 206/306/307/406 Boxer Partner Expet C5 Jumpy Xsara Scudo 2.0JTD Cmax Focus II Grand Vitara C30 C70 S40/80 II V50 V70 III TDI</p>	<p>18-7550900 STD -mm 18-7550900-20 STD -mm (0.2 mm SHORT)</p> <p>18-7550903 0,50 mm 18-7550904 0,60 mm</p> 	<p>A = 46,750 B = 80,750 C = 18,300 E = -1,000 CD= 38,000</p> <p>Ring Carrier Oil Cut-Out</p>	<p>RE47440000 -STD RE47440060 -0,60</p> <p>3,500 (505) Cr P 2,000 (501) P IFU 3,000 (604) Cr P</p>	<p>ø28,0 x 70,0</p>			<p>1,25 mm Gasket +0,55 + 0,60</p> <p>1,30 mm Gasket +0,61 +0,65</p> <p>1,35 mm Gasket +0,66 +0,70</p> <p>1,40 mm Gasket +0,71 +0,75</p>
<p>ø85,00</p> <p>R 4 Diesel, 1997 cm³ 62 88 kW (84 120 PS) DW10BTED4</p> <p><u>1999 - 2007</u></p> <p>(2.0HDI) Berlino C4 16V C4 GrandPicasso 16V C4 Picasso 16V C5 16V C8 16V Jumpy 6V C-Max Kuga 307 16V 307 CC 16V 308 16V 407 16V 508</p>	<p>18-7551920 STD -mm 18-7551924 0,60 mm</p> 	<p>A = 46,705 B = 80,705 C = 15,400 E = -0,520 CD= 44,800</p> <p>Ring Carrier Oil Gallery Oil Cut-Out</p>	<p>RE47440000 -STD RE47440060 -0,60</p> <p>3,500 (505) Cr P 2,000 (501) P IFU 3,000 (604) Cr P</p>	<p>ø28,0 x 70,0</p>			

Engine	Ref. No. - Kit 1	Dimensions	Rings	Pin	Piston Liner	Kit 2	Info
<p>ø85,00</p> <p>4 Cyl. Diesel 1997 cc 163PS DW10CTED4 <u>2009 -</u></p> <p>3008 5008 C4 C5 III 2.0 HDI DS4 KUGA</p>	<p>18-7592960 STD -mm 18-7592964 0,50 mm</p>	<p>A = 46,705 B = 74,705 C = 13,710 E = -0,455 CD= 50,400</p> <p>Ring Carrier Oil Gallery Oil Cut-Out</p>	<p>RE47770000 -STD RE47770060 -0,60</p> <p>2,000 () 2,000 () P 2,000 ()</p>	<p>ø30,0 x 68,0</p>			
<p>ø86,00</p> <p>R 4 Petrol, 1998 cm³ 88 92 kW (120 125 hp) 10,3:1 N8A N8B N8C N8D N9A N9B N9C N9D N9E N9F NES <u>1989-1994</u></p> <p>Sierra Scorpio Galaxy Granada Sapphire Transit</p>	<p>18-2510410 STD -mm 18-2510413 0,50 mm</p>	<p>A = 32,270 B = 62,270 E = -2,000</p> <p>Steel Support</p>	<p>RE23410000 -STD RE23410050 -0,50</p> <p>1,600 (500) Cr P IF 1,750 (508) P 3,000 (700) Cr P S</p>	<p>ø20,6 x 63,5</p>			

Engine	Ref. No. - Kit 1	Dimensions	Rings	Pin	Piston Liner	Kit 2	Info
<p>ø86,00</p> <p>R 4 Petrol, 1998 cm³ 85 kW (115 hp), 8,6:1 N9K N9L NSD NSE NSF <u>4/1994..</u> Sierra Scorpio Tourneo</p>	<p>14-2510510 STD -mm 14-2510513 0,50 mm</p>	<p>A = 32,270 B = 62,270 C = 1,200 E = -1,200 CD= 60,000</p>	<p>RE23410000 -STD RE23410050 -0,50</p> <p>1,600 (500) Cr P IF 1,750 (508) P 3,000 (700) Cr P S</p>	<p>ø20,6 x 63,4</p>			
<p>ø86,00</p> <p>4 Cyl. Diesel 1998 cc 125 Ps V185 Duratorq TDC 2000.. CD132 Duratorq TDCI 2001.. <u>2000 -.....</u> Transit 2.0 TDCI 2000> Mondeo 2.0 TDCI 2001></p>	<p>18-2583330 STD -mm 18-2583331 0,25 mm 18-2583333 0,50 mm</p>	<p>A = 47,700 B = 74,100 C = 15,200 CD= 43,300</p> <p>Ring Carrier Oil Gallery</p>	<p>RE23350000 -STD RE23350025 -0,25 RE23350050 -0,50</p> <p>2,000 (500) Cr P IF 2,000 (508) P 2,000 (604) Nit S</p>	<p>ø30,0 x 66,9</p>			<p>1,10 mm Gasket +0,43 +0,52</p> <p>1,15 mm Gasket +0,52 +0,57</p> <p>1,20 mm Gasket +0,57 +0,62</p>

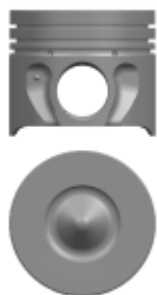

Engine	Ref. No. - Kit 1	Dimensions	Rings	Pin	Piston Liner	Kit 2	Info
<p>ø86,00</p> <p>R 4 Petrol, 1998 cm³ 88 92 kW (120 125 hp) 10,3:1 N8A N8B N8C N8D N9A N9B N9C N9D N9E N9F NES</p> <p><u>1989-1994</u></p> <p>Sierra Scorpio Galaxy Granada Sapphire Transit</p> 	<p>18-2510410 STD -mm 18-2510413 0,50 mm</p>	<p>A = 32,270 B = 62,270 E = -2,000</p> <p>Steel Support</p>	<p>RE23410000 -STD RE23410050 -0,50</p> <p>1,600 (500) Cr P IF 1,750 (508) P 3,000 (700) Cr P S</p>	<p>ø20,6 x 63,5</p>			
<p>ø86,00</p> <p>R 4 Petrol, 1998 cm³ 85 kW (115 hp), 8,6:1 N9K N9L NSD NSE NSF</p> <p><u>4/1994..</u></p> <p>Sierra Scorpio Tourneo</p>	<p>14-2510510 STD -mm 14-2510513 0,50 mm</p>	<p>A = 32,270 B = 62,270 C = 1,200 E = -1,200 CD= 60,000</p>	<p>RE23410000 -STD RE23410050 -0,50</p> <p>1,600 (500) Cr P IF 1,750 (508) P 3,000 (700) Cr P S</p>	<p>ø20,6 x 63,4</p>			



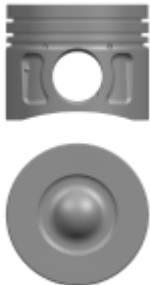
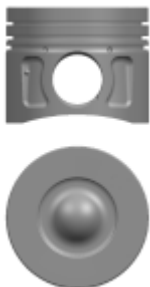



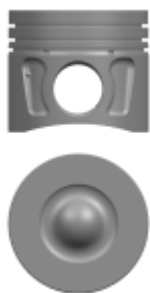

Engine	Ref. No. - Kit 1	Dimensions	Rings	Pin	Piston Liner	Kit 2	Info
<p>ø86,01</p> <p>4 Cyl. Diesel 1998 cc 75/85/90/100 Ps 18,2:1 V185 Duratorq TDI CD132 Duratorq TDI <u>2000/2001 -</u> Turbo-Intercooler Mondeo III 2,0 TDCi Transit 2,0 TDCi</p>	<p>18-2550340 STD -mm <i>18-2550340-20 STD -mm (0.2 mm SHORT)</i> 18-2550341 0,25 mm 18-2550343 0,50 mm <i>18-2550343-20 0,50 mm (0.2 mm SHORT)</i></p>	<p>A = 47,580 B = 73,980 C = 16,500 CD= 40,200</p> <p>Ring Carrier</p>	<p>RE23350000 -STD RE23350025 -0,25 RE23350050 -0,50</p> <p>2,000 (500) Cr P IF 2,000 (508) P 2,000 (604) Nit S</p>	<p>ø30,0 x 66,9</p>		<p>1,10 mm Gasket +0,43 +0,52</p> <p>1,15 mm Gasket +0,52 +0,57</p> <p>1,20 mm Gasket +0,57 +0,62</p>	
<p>ø86,01</p> <p>4 Cyl. Diesel 2200 cc 100 Ps V347 Duratorq <u>2003..</u> Transit 2.2 TDCI</p>	<p>18-2582340 STD -mm <i>18-2582340-20 STD -mm (0.2 mm SHORT)</i> 18-2582341 0,25 mm 18-2582343 0,50 mm <i>18-2582343-20 0,50 mm (0.2 mm SHORT)</i></p>	<p>A = 43,420 B = 69,820 C = 15,850 CD= 46,900</p> <p>Ring Carrier</p>	<p>RE23350000 -STD RE23350025 -0,25 RE23350050 -0,50</p> <p>2,000 (500) Cr P IF 2,000 (508) P 2,000 (604) Nit S</p>	<p>ø30,0 x 66,9</p>		<p>1,10 mm Gasket +0,43 +0,52</p> <p>1,15 mm Gasket +0,52 +0,57</p> <p>1,20 mm Gasket +0,57 +0,62</p>	

Engine	Ref. No. - Kit 1	Dimensions	Rings	Pin	Piston Liner	Kit 2	Info
<p>ø86,01</p> <p>4 Cyl. Diesel 2198 cc 100/120/130 Ps 17,5:1 QWFB/V347 Duratorq Euro 4 Duratorq/V347 D <u>2003/2008..</u></p> <p><i>Common Rail Transit 2.2 TDCI Yeni Jumper 2.2 HDI Ducato 100 Multijet Yeni Boxer HDI</i></p> 	<p>18-2582350 STD -mm <i>18-2582350-20 STD -mm (0.2 mm SHORT)</i></p> <p>18-2582351 0,25 mm 18-2582353 0,50 mm <i>18-2582353-20 0,50 mm (0.2 mm SHORT)</i></p>	<p>A = 43,420 B = 69,820 C = 15,850 CD= 46,900</p> <p>Ring Carrier Oil Gallery</p>	<p>RE23350000 -STD RE23350025 -0,25 RE23350050 -0,50</p> <p>2,000 (500) Cr P IF 2,000 (508) P 2,000 (604) Nit S</p>	<p>ø30,0 x 66,9</p>			<p>1,10 mm Gasket +0,38 +0,47</p> <p>1,20 mm Gasket +0,48 +0,58</p> <p>1,30 mm Gasket + 0,59 +0,68</p>
<p>ø86,01</p> <p>4 Cyl. Diesel 2200 cc 150 Ps CD132 Duratorq TDCI <u>2003..</u></p> <p><i>Mondeo 2.2 TDCI Transit 2.2 TDCI</i></p> 	<p>18-2582360 STD -mm 18-2582361 0,25 mm 18-2582363 0,50 mm</p>	<p>A = 43,420 B = 69,820 C = 15,850 CD= 46,900</p> <p>Ring Carrier Oil Gallery</p>	<p>RE23350000 -STD RE23350025 -0,25 RE23350050 -0,50</p> <p>2,000 (500) Cr P IF 2,000 (508) P 2,000 (604) Nit S</p>	<p>ø30,0 x 66,9</p>			<p>1,10 mm Gasket +0,43 +0,52</p> <p>1,15 mm Gasket +0,52 +0,57</p> <p>1,20 mm Gasket +0,57 +0,62</p>

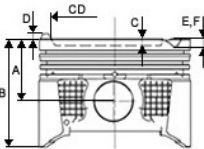
Engine	Ref. No. - Kit 1	Dimensions	Rings	Pin	Piston Liner	Kit 2	Info
<p>ø86,01</p> <p>4 Cyl. Diesel 1988 cc 125 Ps 19:1 CD132 V185 X400 <u>2003..</u></p> <p><i>Mondeo 2.0 TDCI Transit 300 SF Journey Deluxe</i></p>	<p>18-2582370 STD -mm 18-2582371 0,25 mm 18-2582373 0,50 mm</p>	<p>A = 47,700 B = 74,100 C = 14,800 CD= 48,100</p> <p>Ring Carrier Oil Gallery</p>	<p>RE23350000 -STD RE23350025 -0,25 RE23350050 -0,50</p> <p>2,000 (500) Cr P IF 2,000 (508) P 2,000 (604) Nit S</p>	<p>ø100,0 x 0,0</p>			<p>1,10 mm Gasket +0,43 +0,52</p> <p>1,15 mm Gasket +0,52 +0,57</p> <p>1,20 mm Gasket +0,57 +0,62</p>
<p>ø86,01</p> <p>4 Cyl. Gasoline 2198/2179 cc 155 PS 74 Kw (100 Ps) 15,5:1 2.2L Duratorq/HDI (CUFF,CUF5,CVR5,UYRG)) <u>2002 -</u></p> <p><i>Euro 5 TRANSIT 2.2 (YENI) Boxer 2.2L</i></p>	<p>18-2582420 STD -mm 18-2582420-20 STD -mm (0.2 mm SHORT) 18-2582421 0,25 mm 18-2582423 0,50 mm 18-2582423-20 0,50 mm (0.2 mm SHORT)</p>	<p>A = 48,420 B = 74,820 C = 16,170 CD= 49,040</p> <p>Ring Carrier Oil Gallery Oil Cut-Out</p>	<p>RE23350000 -STD RE23350025 -0,25 RE23350050 -0,50</p> <p>2,000 (500) Cr P IF 2,000 (508) P 2,000 (604) Nit S</p>	<p>ø30,0 x 66,9</p>			

Engine	Ref. No. - Kit 1	Dimensions	Rings	Pin	Piston Liner	Kit 2	Info
<p>ø86,01</p> <p>4 Cyl. Diesel 2198 cc 125PS/135PS 15,5:1 Euro 5 2.2L Duratorq (CYFS,U5R6) <u>2006 - 2011</u></p> <p><i>Transit 330S Transit 350M/350MF Transit 370M-410L-460 ED</i></p>	<p>18-2582600 STD -mm <i>18-2582600-20 STD -mm (0.2 mm SHORT)</i></p> <p>18-2582601 0,25 mm 18-2582603 0,50 mm <i>18-2582603-20 0,50 mm (0.2 mm SHORT)</i></p>	<p>A = 48,420 B = 74,820 C = 15,850 CD= 46,900</p> <p>Ring Carrier Oil Gallery Oil Cut-Out</p>	<p>RE23350000 -STD RE23350025 -0,25 RE23350050 -0,50</p> <p>2,000 (500) Cr P IF 2,000 (508) P 2,000 (604) Nit S</p>	<p>ø30,0 x 66,9</p>			
<p>ø87,50</p> <p>4 Cyl. Gasoline 2000cc 145 Ps HE DURATEC <u>2001....</u></p> <p><i>Mondeo 2,0 Mazda 6 2,0i 16v Atenza 2,0i 16v</i></p>	<p>18-2510310 STD -mm 18-2510313 0,50 mm</p>	<p>A = 28,400 B = 51,000 C = 0,350 CD= 75,400</p>	<p>RE23470000 -STD RE23470050 -0,50</p> <p>1,200 (500) Cr4B S 1,200 (501) P IFU 2,500 (700) Cr P S</p>	<p>ø21,0 x 60,0</p>			



							
Engine	Ref. No. - Kit 1	Dimensions	Rings	Pin	Piston Liner	Kit 2	Info
<p>ø87,65</p> <p>4 Cyl. Gasoline 1576 cc 50/51,5/53,5 Kw LC <u>1970 - 1982</u></p> <p><i>Taunus Capri Cortina Transit</i></p>	<p>14-2510080 STD -mm 14-2510083 0,50 mm</p>	<p>A = 39,970 B = 71,970</p> <p>Steel Support</p>	<p>RE23230000 -STD RE23230020 -0,20 RE23230040 -0,40 RE23230050 -0,50 RE23230051 -0,508 RE23230100 -1,00 RE23230102 -1,016</p> <p>2,000 (500) CrB Fe S 2,500 (501) P 4,000 (700) Cr P S</p>	<p>ø24,0 x 73,0</p>			
<p>ø87,65</p> <p>4 Cyl. Gasoline 1576 cc 53/53,5/64,5 Kw HC <u>1970 - 1981</u></p> <p><i>Taunus Capri Escort Cortina Granada</i></p>	<p>14-2510090 STD -mm 14-2510093 0,50 mm 14-2510098 1,00 mm</p>	<p>A = 41,100 B = 73,100</p> <p>Steel Support</p>	<p>RE23230000 -STD RE23230020 -0,20 RE23230040 -0,40 RE23230050 -0,50 RE23230051 -0,508 RE23230100 -1,00 RE23230102 -1,016</p> <p>2,000 (500) CrB Fe S 2,500 (501) P 4,000 (700) Cr P S</p>	<p>ø24,0 x 73,0</p>			

Engine	Ref. No. - Kit 1	Dimensions	Rings	Pin	Piston Liner	Kit 2	Info
<p>ø88,00</p> <p>4 Cyl. Diesel 1975/1987/1990 cc 32/40/42/44 Kw (49/54/5760 Ps) VTA XDP4.88 XD 4.88 XD 88 XD P 4.88/4.88/88</p> <p><u>1987</u></p> <p>504 1.9D 404 1.9D 404 2.0D/504 2.0D J 7 1.9 D Granada 2.0D</p>	<p>14-7550930 STD -mm</p>	<p>A = 58,700 B = 95,700 C = 1,950</p>	<p>RE47140000 -STD</p> <p>2,000 (500) Cr 2,000 (501) P 2,000 (508) P 4,500 (604) P</p>	<p>ø28,0 x 68,0</p>			
<p>ø89,90</p> <p>4 Cyl. Diesel 2402cc 66 Kw (90 PS) 19:1 D2FA D2FB D2FE D4FA</p> <p><u>2000 - 2003</u></p> <p>Transit 2,4 Di Transit 2,4 TDE</p>	<p>18-2550230 STD -mm 18-2550230-20 STD -mm (0.2 mm SHORT) 18-2550231 0,25 mm 18-2550233 0,50 mm</p>	<p>A = 53,500 B = 80,500 C = 17,000 CD= 41,050</p> <p>Ring Carrier</p>	<p>RE23170000 -STD RE23170025 -0,25 RE23170050 -0,50</p> <p>2,500 (503) Cr P 2,000 (501) P IF 3,000 (604) Cr P</p>	<p>ø32,0 x 66,2</p>			<p>1,10 mm Gasket +0,30 +0,40</p> <p>1,15 mm Gasket +0,40 +0,45</p> <p>1,20 mm Gasket +0,45 +0,50</p>

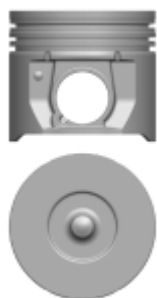

Engine	Ref. No. - Kit 1	Dimensions	Rings	Pin	Piston Liner	Kit 2	Info
<p>ø89,90</p> <p>4 Cyl. Diesel 2402 cc 66 Kw (90 Ps) HEFA HFFA <u>2003 - 2006</u> <i>Transit 300S Transit 330S</i></p>	<p>18-2550240 STD -mm <i>18-2550240-20 STD -mm (0.2 mm SHORT)</i></p> <p>18-2550241 0,25 mm 18-2550243 0,50 mm <i>18-2550243-20 0,50 mm (0.2 mm SHORT)</i></p>	<p>A = 53,500 B = 80,500 C = 17,240 CD= 41,050</p> <p>Ring Carrier</p>	<p>RE23520000 -STD RE23520025 -0,25 RE23520050 -0,50</p> <p>2,000 (500) Cr P 2,000 (508) P 2,000 (604) Nit S</p>	<p>ø32,0 x 66,2</p>			<p>1,10 mm Gasket +0,30 +0,40</p> <p>1,15 mm Gasket +0,40 +0,45</p> <p>1,20 mm Gasket +0,45 +0,50</p>
<p>ø89,90</p> <p>4 Cyl. Diesel 2400 cc 115 143 Ps SXFA SVFB V 348 DURATORQ (Cooling Channel) <u>2004-2013</u> <i>Transit 2,4 TDi</i></p>	<p>18-2582330 STD -mm <i>18-2582330-20 STD -mm (0.2 mm SHORT)</i></p> <p>18-2582331 0,25 mm 18-2582333 0,50 mm <i>18-2582333-20 0,50 mm (0.2 mm SHORT)</i></p>	<p>A = 53,500 B = 80,500 C = 16,300 CD= 49,000</p> <p>Ring Carrier Oil Gallery Oil Cut-Out</p>	<p>RE23520000 -STD RE23520025 -0,25 RE23520050 -0,50</p> <p>2,000 (500) Cr P 2,000 (508) P 2,000 (604) Nit S</p>	<p>ø32,0 x 71,1</p>			<p>1,10 mm Gasket +0,30 +0,40</p> <p>1,15 mm Gasket +0,40 +0,45</p> <p>1,20 mm Gasket +0,45 +0,50</p>

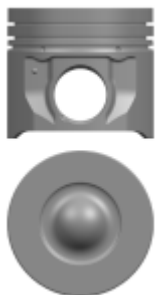

Engine	Ref. No. - Kit 1	Dimensions	Rings	Pin	Piston Liner	Kit 2	Info
<p>ø89,90</p> <p>4 Cyl. Diesel 2402 cc 88 Kw (120 Ps) 19:1 D4FA DURATORQ Cooling Channel <u>2000 - 2003</u> Transit 2,4 TDi</p>	<p>18-2582440 STD -mm 18-2582440-20 STD -mm (0.2 mm SHORT) 18-2582441 0,25 mm 18-2582443 0,50 mm</p>	<p>A = 53,500 B = 80,500 C = 17,240 CD= 40,400</p> <p>Ring Carrier Oil Gallery</p>	<p>RE23170000 -STD RE23170025 -0,25 RE23170050 -0,50</p> <p>2,500 (503) Cr P 2,000 (501) P IF 3,000 (604) Cr P</p>	<p>ø32,0 x 71,1</p>			<p>1,10 mm Gasket +0,30 +0,40</p> <p>1,15 mm Gasket +0,40 +0,45</p> <p>1,20 mm Gasket +0,45 +0,50</p>
<p>ø89,90</p> <p>4 Cyl. Diesel 2402 cc 100 120 Ps 19:1 HFFA RBFA V184 Tdi (Cooling Channel) <u>2003 - 2006</u> Transit 2,4 TDi</p>	<p>18-2582550 STD -mm 18-2582550-20 STD -mm (0.2 mm SHORT) 18-2582551 0,25 mm 18-2582553 0,50 mm 18-2582553-20 0,50 mm (0.2 mm SHORT)</p>	<p>A = 53,500 B = 80,500 C = 17,240 CD= 40,400</p> <p>Ring Carrier Oil Gallery Oil Cut-Out</p>	<p>RE23520000 -STD RE23520025 -0,25 RE23520050 -0,50</p> <p>2,000 (500) Cr P 2,000 (508) P 2,000 (604) Nit S</p>	<p>ø32,0 x 71,1</p>			<p>1,10 mm Gasket +0,30 +0,40</p> <p>1,15 mm Gasket +0,40 +0,45</p> <p>1,20 mm Gasket +0,45 +0,50</p>

Engine	Ref. No. - Kit 1	Dimensions	Rings	Pin	Piston Liner	Kit 2	Info
<p>ø89,91</p> <p>4 Cyl. Diesel 2400 cc 100 Ps V348 TDCI 2006 -.... Transit 2,4 TDI 2006></p>	<p>18-2550250 STD -mm 18-2550250-20 STD -mm (0.2 mm SHORT) 18-2550251 0,25 mm 18-2550253 0,50 mm 18-2550253-20 0,50 mm (0.2 mm SHORT)</p>	<p>A = 53,500 B = 80,500 C = 16,300</p> <p>Ring Carrier</p>	<p>RE23520000 -STD RE23520025 -0,25 RE23520050 -0,50</p> <p>2,000 (500) Cr P 2,000 (508) P 2,000 (604) Nit S</p>	<p>ø32,0 x 66,2</p>			
<p>ø89,91</p> <p>4 Cyl. Diesel 2400 cc 125 Ps V184 TDI 2003 -.... Duratorq Transit 2.4 TDI</p>	<p>18-2582390 STD -mm 18-2582390-20 STD -mm (0.2 mm SHORT) 18-2582391 0,25 mm 18-2582393 0,50 mm 18-2582393-20 0,50 mm (0.2 mm SHORT)</p>	<p>A = 53,500 B = 80,500 C = 17,240 CD= 40,400</p> <p>Ring Carrier Oil Gallery Oil Cut-Out</p>	<p>RE23520000 -STD RE23520025 -0,25 RE23520050 -0,50</p> <p>2,000 (500) Cr P 2,000 (508) P 2,000 (604) Nit S</p>	<p>ø32,0 x 71,1</p>			



Engine	Ref. No. - Kit 1	Dimensions	Rings	Pin	Piston Liner	Kit 2	Info
<p>ø89,91</p> <p>4 Cyl. Diesel 2400 cc 135 Ps V184 TDCI</p> <p>2,4 Duratorq Transit 2,4 TDCI</p>	<p>18-2582570 STD -mm 18-2582571 0,25 mm 18-2582573 0,50 mm</p>	<p>A = 53,500 B = 80,500 C = 15,620 CD= 47,100</p> <p>Ring Carrier Oil Gallery</p>	<p>RE23520000 -STD RE23520025 -0,25 RE23520050 -0,50</p> <p>2,000 (500) Cr P 2,000 (508) P 2,000 (604) Nit S</p>	<p>ø32,0 x 71,1</p>			
<p>ø89,91</p> <p>5 Cyl. Diesel 3200cc 200 HP V348 TDCI 2006.. Transit 3.2</p>	<p>18-2582580 STD -mm 18-2582580-20 STD -mm (0.2 mm SHORT) 18-2582581 0,25 mm 18-2582583 0,50 mm 18-2582583-20 0,50 mm (0.2 mm SHORT)</p>	<p>A = 48,220 B = 75,220 C = 16,700 CD= 50,200</p> <p>Ring Carrier Oil Gallery Oil Cut-Out</p>	<p>RE23520000 -STD RE23520025 -0,25 RE23520050 -0,50</p> <p>2,000 (500) Cr P 2,000 (508) P 2,000 (604) Nit S</p>	<p>ø32,0 x 74,1</p>			

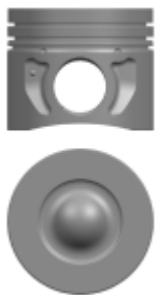
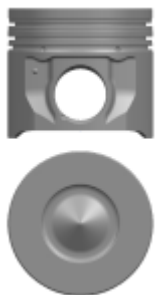



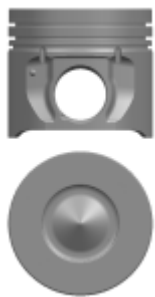





Engine	Ref. No. - Kit 1	Dimensions	Rings	Pin	Piston Liner	Kit 2	Info
<p>ø89,91</p> <p>4 Cyl. Diesel 2400 cc 130 Ps RCFA V184 Dti (Cooling Channel) <u>2003-....</u> <i>Transit 2,4 TDi</i></p>	<p>18-2582660 STD -mm <i>18-2582660-20 STD -mm (0.2 mm SHORT)</i> 18-2582661 0,25 mm 18-2582663 0,50 mm <i>18-2582663-20 0,50 mm (0.2 mm SHORT)</i></p>	<p>A = 53,500 B = 80,500 C = 15,620 CD= 47,100</p> <p>Ring Carrier Oil Gallery Oil Cut-Out</p>	<p>RE23520000 -STD RE23520025 -0,25 RE23520050 -0,50</p> <p>2,000 (500) Cr P 2,000 (508) P 2,000 (604) Nit S</p>	<p>ø32,0 x 71,1</p>			<p>1,10 mm Gasket +0,30 +0,40</p> <p>1,15 mm Gasket +0,40 +0,45</p> <p>1,20 mm Gasket +0,45 +0,50</p>
<p>ø90,00</p> <p>V 6 Petrol, 2293 cm³ 79,5 92 kW (108 125 hp) 9,1:1 2293 92 Kw <u>1974-84</u> <i>Taunus Capri Escort Sierra Granada</i></p>	<p>14-2510650 STD -mm 14-2510653 0,50 mm</p>	<p>A = 44,700 B = 79,200</p>	<p>RE23250000 -STD RE23250050 -0,50 RE23250100 -1,00</p> <p>2,000 (500) Cr IF 3,000 (501) P 4,000 (700) Cr P S</p>	<p>ø24,0 x 70,0</p>			



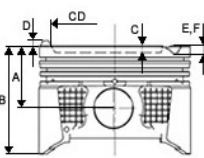





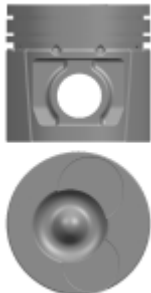

Engine	Ref. No. - Kit 1	Dimensions	Rings	Pin	Piston Liner	Kit 2	Info
<p>ø90,00</p> <p>4 Cyl. Diesel 2112 cc 46/43/48/55/78 Kw (59/63/56/75/95/106 Ps) XD4.90 XDP4.90 XDP6.90WTA <u>1969....</u></p> <p><i>J 7 2.1 D</i> <i>504 2.1 D</i> <i>J 9 2.1 D</i> <i>J 7 2.1 D</i> <i>Granada 2.1 D</i> <i>Blitz 2.1 D</i></p>	<p>14-7550940 STD -mm 14-7550943 0,50 mm 14-7550948 1,00 mm</p>	<p>A = 57,200 B = 96,350 C = 2,000</p>	<p>RE47170000 -STD RE47170050 -STD RE47170100 -STD</p> <p>2,000 (500) Cr 2,000 (501) P 2,000 (508) P 4,500 (604) P</p>	<p>ø28,0 x 77,0</p>			
<p>ø90,80</p> <p>R 4 Petrol, 1998 cm³ 57 64 kW (78 87 hp), 8,6:1 LC <u>1970-82</u></p> <p><i>Taunus</i> <i>Capri</i> <i>Escort</i> <i>Sierra</i> <i>Granada</i></p>	<p>14-2510400 STD -mm 14-2510403 0,50 mm</p>	<p>A = 40,250 B = 68,250</p>	<p>RE23270000 -STD</p> <p>1,600 (500) Cr P 2,000 (501) P 4,000 (700) Cr P S</p>	<p>ø24,0 x 70,0</p>			

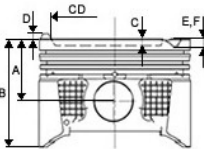
Engine	Ref. No. - Kit 1	Dimensions	Rings	Pin	Piston Liner	Kit 2	Info
<p>ø90,80</p> <p>R 4 Petrol, 1994 cm³ 73,5 kW (100 hp), 9,2:1 HC <u>1986-1993</u></p> <p><i>Taurus Capri Escort Sierra Granada</i></p>	<p>14-2510450 STD -mm 14-2510453 0,50 mm 14-2510458 1,00 mm</p>	<p>A = 41,550 B = 69,550</p>	<p>RE23270000 -STD</p> <p>1,600 (500) Cr P 2,000 (501) P 4,000 (700) Cr P S</p>	<p>ø24,0 x 70,0</p>			
<p>ø93,00</p> <p>4 Cyl. Diesel 2500 cc 79 Ps XM34 WLOHC (1997 2004)</p> <p><i>Ranger Pick Up B2500 Pick Up</i></p>	<p>18-2581980 STD -mm 18-2581983 0,50 mm</p>	<p>A = 47,800 B = 87,400 C = 1,200</p> <p>Ring Carrier Steel Support</p>	<p>RJ30175A00 -STD - RJ30175B00 -0,015 RJ30175C00 -0,02 "</p> <p>2,500 () FX 2,000 () 3,000 ()</p>	<p>" ø32,0 " x 68,0</p>			







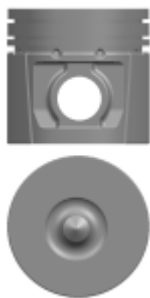

Engine	Ref. No. - Kit 1	Dimensions	Rings	Pin	Piston Liner	Kit 2	Info
<p>ø93,00</p> <p>4 Cyl. Diesel 2500 cc 110 Ps XM34TD XM34TD/WL T <u>1998 -</u></p> <p>Ranger Pick Up Thunder, Ranger Pick Up XLT B2500 TD Ranger</p>	<p>18-2582990 STD -mm 18-2582993 0,50 mm</p>	<p>A = 47,850 B = 87,350 C = 2,100</p> <p>Ring Carrier Oil Gallery Steel Support Oil Cut-Out</p>	<p>RJ30175A00 -STD - " ø32,0 RJ30175B00 -0,015 " x 68,0 RJ30175C00 -0,02 "</p> <p>2,500 () FX 2,000 () 3,000 ()</p>				
<p>ø93,00</p> <p>4 Cyl. Diesel 2499cc 143 PS 6M34 WL C <u>2006 -</u></p> <p>Ranger Pickup TDCI</p>	<p>18-2584020 STD -mm 18-2584023 0,50 mm</p>	<p>A = 51,750 B = 81,300 C = 15,100 CD= 48,500</p> <p>Ring Carrier Oil Gallery</p>	<p>RJ30004A00 -STD - " ø34,0 RJ30004C00 -0,02 " x 70,0</p> <p>2,000 () GN SM 1,500 () RN 2,000 () GN</p>				<p>STDGasket +0,08 +0,15</p> <p>1 Notch Gasket +0,13 +0,25</p> <p>2 Notch Gasket +0,20 +0,31</p>



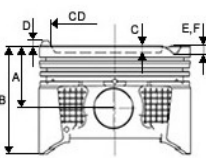





							
Engine	Ref. No. - Kit 1	Dimensions	Rings	Pin	Piston Liner	Kit 2	Info
<p>ø93,67</p> <p>4 Cyl. Diesel 2496 cc 100 Ps 2.5 Di TC <u>2000 -</u></p> <p><i>Transit V5 Minibüs Transit 2,5</i></p>	<p>18-2550880 STD -mm <i>18-2550880-20 STD -mm (0.2 mm SHORT)</i></p> <p>18-2550885 0,65 mm <i>18-2550885-20 0,65 mm (0.2 mm SHORT)</i></p> <p>18-2550888 1,00 mm</p>	<p>A = 59,420 B = 93,950 C = 18,400 CD= 44,000</p> <p>Ring Carrier</p>	<p>RE23510000 -STD RE23510065 -0,65 RE23510100 -1,00</p> <p>2,500 (503) Cr P 2,000 (508) P 4,000 (604) Cr P</p>	<p>ø29,0 x 79,3</p>			
<p>ø93,67</p> <p>4 Cyl. Diesel 2496 cc 51/60 Kw (68 80Ps) 4AB 4BA 4BB 4AC 89 MY D1 M4 T/6110 BA</p> <p><u>1984-1988</u></p> <p><i>Transit 2,5 Triton Motorlar Kamyonet Transit V6 Kamyonet Van V5T2, Minibüs V4.T1 Otosan Transit T3 Transit (80,100,120,130,160,190)</i></p>	 <p>18-2550930 STD -mm 18-2550935 0,65 mm 18-2550938 1,00 mm</p>	<p>A = 59,500 B = 93,500 C = 16,940 E = -0,950 F = -0,600 CD= 46,500</p> <p>Ring Carrier Steel Support</p>	<p>RE23210000 -STD RE23210065 -0,65 RE23210100 -1,00</p> <p>2,500 (505) CrB Fe P S 2,000 (501) P IF 4,000 (604) Cr P</p>	<p>ø29,0 x 77,0</p>			

							
Engine	Ref. No. - Kit 1	Dimensions	Rings	Pin	Piston Liner	Kit 2	Info
<p>ø93,67</p> <p>R 4 Diesel, 2496 cm³ 52 56 kW (71 76 hp) 4FA 4FB 4BC 4CC <u>1998-200</u> Transit 2,5</p>	<p>14-2550940 STD -mm 14-2550945 0,65 mm 14-2550948 1,00 mm</p>	<p>A = 59,500 B = 89,500 C = 18,000 CD= 40,000</p> <p>Ring Carrier Steel Support</p>	<p>RE23210000 -STD RE23210065 -0,65 RE23210100 -1,00</p> <p>2,500 (505) CrB Fe P S 2,000 (501) P IF 4,000 (604) Cr P</p>	<p>ø29,0 x 77,0</p>			
<p>ø93,67</p> <p>4 Cyl. Diesel 2496 cc 73,6 Kw (100 Ps) 944 F 6110 AAC2.5DI 4EA <u>1991 -</u> Otosan Üretimi Minibüs Van Transit 2.5 TD</p>	<p>18-2550950 STD -mm 18-2550950-20 STD -mm (0.2 mm SHORT) 18-2550955 0,65 mm 18-2550955-20 0,65 mm (0.2 mm SHORT) 18-2550958 1,00 mm 18-2550958-20 1,00 mm (0.2 mm SHORT)</p>	<p>A = 59,420 B = 93,950 C = 18,400 CD= 44,000</p> <p>Ring Carrier</p>	<p>RE23210000 -STD RE23210065 -0,65 RE23210100 -1,00</p> <p>2,500 (505) CrB Fe P S 2,000 (501) P IF 4,000 (604) Cr P</p>	<p>ø29,0 x 79,3</p>			

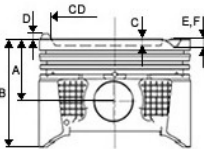







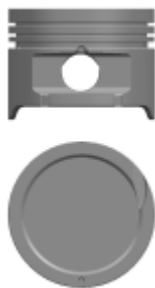

Engine	Ref. No. - Kit 1	Dimensions	Rings	Pin	Piston Liner	Kit 2	Info
<p>ø93,67</p> <p>4 Cyl. Diesel 2496 cc 76 Ps 2.5 DI TC <u>1995 -....</u> Transit 2,5</p>	<p>18-2550960 STD -mm 18-2550960-20 STD -mm (0.2 mm SHORT) 18-2550965 0,65 mm 18-2550965-20 0,65 mm (0.2 mm SHORT) 18-2550968 1,00 mm</p>	<p>A = 59,520 B = 94,000 C = 18,000 CD= 40,000</p> <p>Ring Carrier</p>	<p>RE23510000 -STD RE23510065 -0,65 RE23510100 -1,00</p> <p>2,500 (503) Cr P 2,000 (508) P 4,000 (604) Cr P</p>	<p>ø29,0 x 77,0</p>			<p>+0,25 +0,40</p>
<p>ø93,67</p> <p>4 Cyl. Diesel 2496 cc 76 Ps 4EB 4EC D25T <u>1995 -....</u> Transit 2,5</p>	<p>18-2550970 STD -mm 18-2550975 0,65 mm</p>	<p>A = 59,410 B = 93,950 C = 18,400 CD= 44,000</p> <p>Ring Carrier</p>	<p>RE23510000 -STD RE23510065 -0,65 RE23510100 -1,00</p> <p>2,500 (503) Cr P 2,000 (508) P 4,000 (604) Cr P</p>	<p>ø29,0 x 77,0</p>			

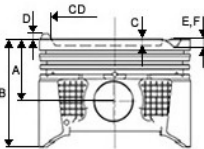
							
Engine	Ref. No. - Kit 1	Dimensions	Rings	Pin	Piston Liner	Kit 2	Info
<p>ø93,67</p> <p>4 Cyl. Diesel 2358 cc 43,5/45,5 Kw 2401 E YORK 2402 E YORK</p> <p><u>1992 -.....</u></p> <p>A0505 A0609 Transit FT7/80/902 /100/115 Transit FT7120/125 /130/150/160 A0409 A0509 A0609 A0709</p>	<p>14-2552140 STD -mm 14-2552145 0,65 mm 14-2552148 1,00 mm</p>	<p>A = 61,670 B = 108,000 C = 0,800</p>	<p>RE23490000 -STD RE23490065 -0,65 RE23490100 -1,00</p> <p>2,385 (503) Cr P 2,385 (508) P 4,747 (604) Cr P</p>	<p>ø29,0 x 74,5</p>			<p>0,114 +0,213</p>

							
Engine	Ref. No. - Kit 1	Dimensions	Rings	Pin	Piston Liner	Kit 2	Info
<p>ø71,00</p> <p>4 Cyl. Gasoline 1248 cc 57 KW 78 PS 1 G4LA <u>2008 -</u> <i>i10 1,2 16v</i> <i>i20 1,2 16v</i></p>	<p>18-4011010 STD -mm 18-4011013 0,50 mm</p>	<p>A = 24,700 B = 43,900 C = 3,000 E = -2,820 F = -2,670</p>	<p>RJ40023A00 -STD - " ø18,0 RJ40023C00 -0,02 " x 48,0</p> <p>1,000 () 1,200 () 2,000 ()</p>				
<p>ø71,50</p> <p>4 Cyl. Gasoline 1300 cc G4EH <u>1995 - 1998</u> <i>Accent 1,3</i></p>	<p>18-4011050 STD -mm 18-4011053 0,50 mm</p>	<p>A = 31,300 B = 54,400 C = 1,100 E = -2,000 CD= 59,000</p>	<p>RJ40770A00 -STD - " ø18,0 RJ40770C00 -0,02 " x 47,5 RJ40770D00 -0,03 "</p> <p>1,500 () FV 1,500 () 3,000 ()</p>				



							
Engine	Ref. No. - Kit 1	Dimensions	Rings	Pin	Piston Liner	Kit 2	Info
<p>ø71,50</p> <p>4 Cyl. Gasoline 1300 cc 75 Ps G4K <u>2000-....</u> Accent 1,3</p>	<p>18-4011060 STD -mm 18-4011063 0,50 mm</p>	<p>A = 30,800 B = 53,900 C = 0,700 E = -2,200 CD= 57,900</p>	<p>RJ40770A00 -STD - " ø18,0 RJ40770C00 -0,02 " x 47,5 RJ40770D00 -0,03 "</p> <p>1,500 () FV 1,500 () 3,000 ()</p>				
<p>ø75,00</p> <p>4 Cyl. Gasoline 1500cc G4EC/G G4EB <u>2000-....</u> ACCENT 1,5 MILENYUM</p>	<p>18-4011110 STD -mm 18-4011113 0,50 mm</p>	<p>A = 31,070 B = 54,400 D = 0,950 E = -3,000</p>	<p>RJ40063A00 -STD - " ø18,0 RJ40063C00 -0,02 " x 47,5</p> <p>1,200 () SV 1,500 () 3,000 ()</p>				



Engine	Ref. No. - Kit 1	Dimensions	Rings	Pin	Piston Liner	Kit 2	Info
<p>ø75,00</p> <p>4 Cyl. Diesel 1396 cc 90 D4FC <u>2011 -</u></p> <p><i>Accent 1.4 CRDi i20 1.4 CRDi iX20 1.4 CRDi</i></p>	<p>18-4092510 STD -mm 18-4092513 0,50 mm</p>	<p>A = 44,700 B = 68,500 C = 11,800 E = -0,500 F = -0,500 CD= 43,400</p> <p>Ring Carrier Hard Anodising Oil Gallery</p>	<p>RJ40302A00 -STD - " ø28,0 RJ40302C00 -0,02 " x 62,0</p> <p>1,750 () SM 1,750 () 3,000 ()</p>				
<p>ø75,00</p> <p>4 Cyl. Diesel 1493cc 81 Kw (110 Ps) 17.8:1 D4FA C.Rail <u>2005 -</u></p> <p><i>Accent Era 1.5 CRDI-VGT16v</i></p>	<p>18-4092520 STD -mm 18-4092523 0,50 mm</p>	<p>A = 44,700 B = 68,500 C = 11,800 E = -0,500 CD= 43,400</p> <p>Ring Carrier Oil Gallery Oil Cut-Out</p>	<p>RJ40302A00 -STD - " ø28,0 RJ40302C00 -0,02 " x 62,0</p> <p>1,750 () SM 1,750 () 3,000 ()</p>				

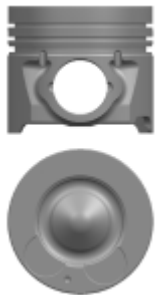
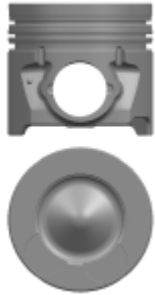

Engine	Ref. No. - Kit 1	Dimensions	Rings	Pin	Piston Liner	Kit 2	Info
<p>ø75,50</p> <p>4 Cyl. Gasoline 1399 cc 97 PS 10:1 G4EE <u>2005 -</u> 1.4 DOCH AccentEra 1.4 16v</p>	<p>18-4011070 STD -mm 18-4011073 0,50 mm</p> 	<p>A = 28,750 B = 47,900 D = 2,200 E = -2,950</p>	<p>RJ40112A00 -STD - " ø18,0 RJ40112C00 -0,02 " x 47,9</p> <p>1,200 () SV 1,200 () 2,000 () GN</p>				
<p>ø75,50</p> <p>4 Cyl. Gasoline 1495 cc G4EK <u>1990 - 2000</u> Accent 1,5</p>	<p>18-4011100 STD -mm 18-4011103 0,50 mm</p>	<p>A = 31,370 B = 54,400 C = 0,700 E = -2,200 CD= 64,300</p>	<p>RJ40765A00 -STD - " ø18,0 RJ40765C00 -0,02 " x 47,5</p> <p>1,500 () RN FV 1,500 () 3,000 ()</p>				

Engine	Ref. No. - Kit 1	Dimensions	Rings	Pin	Piston Liner	Kit 2	Info
<p>ø75,50</p> <p>4 Cyl. Gasoline 1468cc 56 Kw (76 Ps) 8,5:1 G15B <u>1990 - 2004</u> EXCEL 1.5</p>	<p>18-4011120 STD -mm 18-4011123 0,50 mm</p>	<p>A = 29,400 B = 58,800 C = 3,700</p>	<p>RJ20520A00 -STD - " ø18,0 RJ20520C00 -STD - " x 60,0</p> <p>1,500 () FV 1,500 () 4,000 ()</p>				
<p>ø76,50</p> <p>4 Cyl. Gasoline 1588cc 16 Valve G4ED <u>2004 -</u> ACCENT 1.6i 16v</p>	<p>18-4011130 STD -mm 18-4011133 0,50 mm</p>	<p>A = 28,140 B = 50,140 C = 0,400 E = -3,000 CD= 60,400</p>	<p>RJ40082A00 -STD - " ø18,0 RJ40082C00 -0,02 " x 47,5</p> <p>1,200 () RN FV 1,200 () 2,000 ()</p>				

Engine	Ref. No. - Kit 1	Dimensions	Rings	Pin	Piston Liner	Kit 2	Info
<p>ø77,00</p> <p>4 Cyl. Gasoline 1591 cc 95.6 KW 140 PS G4FD <u>2010-.....</u></p> <p><i>Accent 1,6 16v Elantra 1,6 16v I20 1,6 16v I30 1,6 16v IX 35 1,6 16v</i></p>	<p>18-4011190 STD -mm 18-4011193 0,50 mm</p>	<p>A = 26,900 B = 45,000 D = 2,900 E = -2,940 F = -2,700</p> <p>Hard Anodising</p>	<p>RJ40166A00 -STD - " ø18,0 RJ40166C00 -0,02 " x 52,3</p> <p>1,200 () SV 1,200 () 2,000 ()</p>				<p>0,035 0,105 mm</p> <p>0,105 0,175 mm</p> <p>0,175 0,245 mm</p>
<p>ø77,00</p> <p>4 Cyl. Gasoline 1396 cc 81 KW 109 PS G4FA <u>2009-.....</u></p> <p><i>Accent 1,4 16v I20 1,4 16v I30 1,4 16v</i></p>	 <p>18-4011200 STD -mm 18-4011203 0,50 mm</p>	<p>A = 26,900 B = 43,900 C = 1,400 E = -3,100</p>	<p>RJ40166A00 -STD - " ø18,0 RJ40166C00 -0,02 " x 52,3</p> <p>1,200 () SV 1,200 () 2,000 ()</p>				

Engine	Ref. No. - Kit 1	Dimensions	Rings	Pin	Piston Liner	Kit 2	Info
<p>ø77,00</p> <p>4 Cyl. Gasoline 1591 cc 88 KW 120 PS G4FG <u>2011 -....</u></p> <p><i>Elantra 1,6 16v I30 1,6 16v</i></p>	<p>18-4011210 STD -mm 18-4011213 0,50 mm 18-4011215 0,65 mm</p>	<p>A = 26,900 B = 43,900 C = 0,850 E = -2,000 F = -3,000</p> <p>Hard Anodising</p>	<p>RJ40166A00 -STD - " ø18,0 RJ40166C00 -0,02 " x 52,3</p> <p>1,200 () SV 1,200 () 2,000 ()</p>				
<p>ø77,00</p> <p>4 Cyl. Gasoline 1591 cc 96 KW 130 PS G4FC</p> <p><i>i20 1,6 16v I30 1,6 16v</i></p>	<p>18-4011220 STD -mm 18-4011223 0,50 mm</p>	<p>A = 26,900 B = 43,900 C = 0,950 E = -2,800</p>	<p>RJ40166A00 -STD - " ø18,0 RJ40166C00 -0,02 " x 52,3</p> <p>1,200 () SV 1,200 () 2,000 ()</p>				





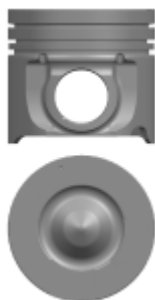







Engine	Ref. No. - Kit 1	Dimensions	Rings	Pin	Piston Liner	Kit 2	Info
<p>ø83,00</p> <p>4 Cyl. Diesel 1493/1991 cc 60/82/100 Kw (82/112 Ps) 17.7:11 D3EA D4EA <u>2001 -</u></p> <p><i>Accent 1.5 CRDI Getz 1.5 CRDI Tuscon 2.0 CRDI Santa FE 2.0 CRDI Sportage 2. CRDI Carens 2.0 CRDI</i></p>	<p>18-4094540 STD -mm <i>18-4094540-20 STD -mm (0.2 mm SHORT)</i></p> <p>18-4094543 0,50 mm <i>18-4094543-20 0,50 mm (0.2 mm SHORT)</i></p>	<p>A = 46,300 B = 72,300 C = 13,900 CD= 46,950</p> <p>Ring Carrier Oil Cut-Out Bushing</p>	<p>RJ39597A00 -STD - " RJ39597C00 -0,02 "</p> <p>2,000 () 2,000 () 3,000 ()</p>				
<p>ø91,00</p> <p>4 Cyl. Diesel 2497 cc 103 Kw (140 Ps) D4CB CRDI <u>2002 -</u></p> <p><i>Starex 2.5 CRDI Sorento</i></p>	<p>18-4050050 STD -mm 18-4050053 0,50 mm</p>	<p>A = 54,250 B = 83,750 C = 15,000 E = -0,300 CD= 52,000</p> <p>Ring Carrier Oil Gallery Oil Cut-Out</p>	<p>RJ39613A00 -STD - " RJ39613C00 -0,02 "</p> <p>2,500 () 2,000 () 3,000 ()</p>	<p>ø33,0 x 75,0</p>			<p>+ 0,06 + 0,24</p>



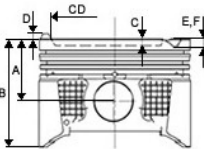







Engine	Ref. No. - Kit 1	Dimensions	Rings	Pin	Piston Liner	Kit 2	Info
<p>ø91,00</p> <p>4 Cyl. Diesel 2497 cc 125 Kw (170 BG) D4BC-..... <i>Stratex 2.5 CRDI</i></p>	<p>18-4094900 STD -mm 18-4094903 0,50 mm</p>	<p>A = 54,250 B = 83,700 C = 15,000 E = -0,340 CD= 52,000</p> <p>Ring Carrier Oil Gallery Oil Cut-Out Bushing</p>	<p>RJ39613A00 -STD - " ϕ33,0 RJ39613C00 -0,02 " x 68,0</p> <p>2,500 () 2,000 () 3,000 ()</p>				
<p>ø91,10</p> <p>4 Cyl. Diesel 2467 cc 73 78 Kw (99 106) Ps D4BH 2000 -..... <i>2. & 4. Sil. Turbo Intercooler K2500 TCI Bongo Starex 2500 TCI</i></p>	<p>18-4050020 STD -mm 18-4050020-20 STD -mm (0.2 mm SHORT) 18-4050023 0,50 mm 18-4050023-20 0,50 mm (0.2 mm SHORT)</p>	<p>A = 48,700 B = 88,700 C = 1,300</p> <p>Ring Carrier Oil Gallery Steel Support</p>	<p>RJ40699A00 -STD - " ϕ29,0 RJ40699C00 -0,02 " x 75,0</p> <p>2,500 () RN FM 1,950 () RN 4,000 ()</p>				<p>+ 0,50 + 0,60</p>

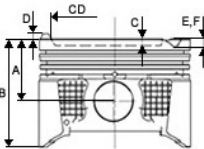







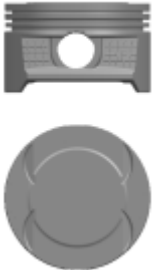
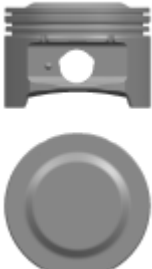

Engine	Ref. No. - Kit 1	Dimensions	Rings	Pin	Piston Liner	Kit 2	Info
<p>ø91,10</p> <p>4 Cyl. Diesel 2467 cc 73 78 Kw (99 106) Ps D4BH <u>2000 -....</u></p> <p><i>1. & 3. Sil. Turbo Intercooler K2500 TCI Bongo Starex 2500 TCI</i></p> 	<p>18-4050030 STD -mm <i>18-4050030-20 STD -mm (0.2 mm SHORT)</i></p> <p>18-4050033 0,50 mm <i>18-4050033-20 0,50 mm (0.2 mm SHORT)</i></p>	<p>A = 48,700 B = 88,700 C = 1,300</p> <p>Ring Carrier Oil Gallery Steel Support</p>	<p>RJ40699A00 -STD - " ø29,0 RJ40699C00 -0,02 " x 75,0</p> <p>2,500 () RN FM 1,950 () RN 4,000 ()</p>				<p>+ 0,50 + 0,60</p>
<p>ø91,10</p> <p>4 Cyl. Diesel 2477 cc D4BB <u>1994 -....</u></p> <p><i>H 100 2.5TD 1994> H1 2.5TDI 21:1 57-59Kw 78-80Ps 1997></i></p> 	<p>18-4050040 STD -mm 18-4050043 0,50 mm</p>	<p>A = 48,700 B = 88,700 C = 3,200 D = 1,900 E = -2,500</p> <p>Steel Support</p>	<p>RJ40525A00 -STD - " ø29,0 RJ40525C00 -0,02 " x 75,0</p> <p>2,000 () GN SM 2,000 () CrI 3,000 () GN</p>				<p>1,45 mm Gasket + 0,562 + 0,620</p> <p>1,50 mm Gasket + 0,620 + 0,680</p> <p>1,55 mm Gasket + 0,680 + 0,774</p>

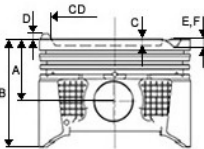
							
Engine	Ref. No. - Kit 1	Dimensions	Rings	Pin	Piston Liner	Kit 2	Info
<p>ø91,10</p> <p>4 Cyl. Diesel 2600 cc H100 <u>1996 -....</u> H 100 Kamyonet Tek ve Çift Kabin</p>	<p>18-4050060 STD -mm 18-4050060-20 STD -mm (0.2 mm SHORT) 18-4050063 0,50 mm</p>	<p>A = 46,250 B = 76,150 C = 3,070 E = -2,000 F = -2,300</p> <p>Ring Carrier</p>	<p>RJ40525A00 -STD - " ø29,0 RJ40525C00 -0,02 " x 75,0</p> <p>2,000 () GN SM 2,000 () CrI 3,000 () GN</p>				<p>1,45 mm Gasket + 0,562 + 0,620</p> <p>1,50 mm Gasket + 0,620 + 0,680</p> <p>1,55 mm Gasket + 0,680 + 0,774</p>
<p>ø91,10</p> <p>4 Cyl. Diesel 2500 cc D4BF <u>1998 -....</u> Starex 2.5 TC</p>	 <p>18-4050070 STD -mm 18-4050073 0,50 mm</p>	<p>A = 48,700 B = 88,700 C = 3,100 E = -2,300 F = -2,600</p> <p>Ring Carrier Steel Support</p>	<p>RJ40699A00 -STD - " ø29,0 RJ40699C00 -0,02 " x 75,0</p> <p>2,500 () RN FM 1,950 () RN 4,000 ()</p>				

							
Engine	Ref. No. - Kit 1	Dimensions	Rings	Pin	Piston Liner	Kit 2	Info
<p>ø104,00</p> <p>4 Cyl. Diesel 3908cc 96 KW 130PS 4D34 1 ATA EUROII</p> <p>659 Canter Prestij TDI-HD 65-HD 72-HD 82</p>	<p>18-1550020 STD -mm 18-1550023 0,50 mm</p>	<p>A = 62,200 B = 112,200 C = 23,000 CD= 49,000</p> <p>Oil Gallery Steel Support Oil Cut-Out</p>	<p>RJ20941A00 -STD - " RJ20941C00 -0,02 "</p> <p>3,000 () RN FM 2,000 () 4,000 ()</p>				<p>+ 0,60 + 0,70</p>









Engine	Ref. No. - Kit 1	Dimensions	Rings	Pin	Piston Liner	Kit 2	Info
<p>ø73,40</p> <p>4 Cyl. Gasoline 1229 cc 59 KW (80 PS) Z12XEP <u>2004 -....</u></p> <p><i>Corça C Agila Astra H Astra MK</i></p> 	<p>18-3010150 STD -mm 18-3010153 0,50 mm</p>	<p>A = 24,000 B = 45,000 D = 0,530 E = -1,460 F = -1,490</p>	<p>RE43390000 -STD RE43390050 -0,50</p> <p>1,200 (500) NitBS 1,200 (508) P 2,000 (700) CrPS</p>	<p>ø18,0 x 50,9</p>			
<p>ø77,60</p> <p>4 Cyl. Gasoline 1389 cc 66 Kw (90 Ps) Z1.4XE GLHB <u>1999 -....</u></p> <p><i>Astra 1.4 Corça 1.4 E16 SE16V C16 SE ENJ/KAT</i></p> 	<p>18-3010300 STD -mm 18-3010303 0,50 mm</p>	<p>A = 31,300 B = 55,750 D = 2,450</p>	<p>RE43480000 -STD RE43480050 -0,50 RE43480100 -1,00</p> <p>1,200 (500) NitB S 1,500 (501) P 2,000 (700) Cr P S</p>	<p>ø18,0 x 55,0</p>			

							
Engine	Ref. No. - Kit 1	Dimensions	Rings	Pin	Piston Liner	Kit 2	Info
<p>ø79,00</p> <p>4Cyl. Gasoline 1598 cc 74 Kw (101 Ps) Y16 XE Z16XE <u>2000 -.....</u></p> <p>Vectra 1.6i 16v Astra 1.6i Meriva 1.6i 16v Zafira 1.6i 16v</p>	<p>18-3010390 STD -mm 18-3010393 0,50 mm</p>	<p>A = 27,200 B = 50,200</p>	<p>RE43320000 -STD RE43320050 -0,50</p> <p>1,200 (500) CrB S 1,500 (508) P 2,500 (700) Cr P S</p>	<p>ø18,0 x 55,0</p>			
<p>ø81,60</p> <p>R 4 Petrol, 1796 cm³ 92 kW (125 hp) C18XE C18XEL <u>1993-2000</u></p> <p>Astra F Vectra B</p>	<p>18-3010790 STD -mm 18-3010793 0,50 mm</p>	<p>A = 30,400 B = 50,400 C = 1,840 E = -1,790 CD= 50,800</p>	<p>RE43140000 -STD RE43140050 -0,50 RE43140100 -1,00</p> <p>1,500 (500) CrB S IF 1,500 (508) P 3,000 (700) Cr P S</p>	<p>ø21,0 x 61,5</p>			

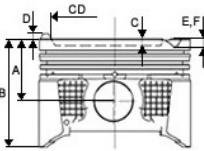





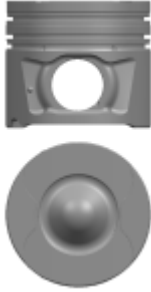



Engine	Ref. No. - Kit 1	Dimensions	Rings	Pin	Piston Liner	Kit 2	Info
<p>ø86,00</p> <p>R 4 Petrol, 2198 cm³ 106 kW (144 hp), 10,5: Y22XE Z22XE <u>1993-2003</u></p> <p>Omega B 2.2 16V Omega 2.2 16V</p>	<p>18-3010610 STD -mm 18-3010613 0,50 mm</p>	<p>A = 27,600 B = 55,000 D = 2,400</p>	<p>RE43430000 -STD RE43430050 -0,50</p> <p>1,200 (500) NitB S 1,500 (508) P 2,500 (700) Cr P S</p>	<p>ø21,0 x 61,5</p>			
<p>ø94,40</p> <p>4 Cyl. Diesel 2798 cc 76 Kw (103 Ps) 18,5:1 Sofim Turbo, Intercooler Euro 2 SOFIM TurboS9W700 702</p> <p><u>1996 -....</u></p> <p>Movano 2,8 TD Ducato 2,8 TD 49.10 49.12 M14 Minibus Turbo Daily35.12 Motor No: 2572280 --> Boxer 2,8 TD Master 2,8 TDI Jumper 2,8 TD</p>	<p>18-3051670 STD -mm 18-3051670-20 STD -mm (0.2 mm SHORT) 18-3051672 0,40 mm 18-3051672-20 0,40 mm (0.2 mm SHORT) 18-3051674 0,60 mm 18-3051674-20 0,60 mm (0.2 mm SHORT)</p>	<p>A = 58,750 B = 87,600 C = 19,400 CD= 39,500</p> <p>Ring Carrier Oil Gallery Oil Cut-Out</p>	<p>RE22780000 -STD RE22780040 -0,40 RE22780060 -0,60</p> <p>2,500 (504) Cr P 2,000 (501) P 2,500 (604) Cr P</p>	<p>ø32,0 x 72,0</p>		<p>1,20 mm Gasket +0,40 +0,50</p> <p>1,30 mm Gasket +0,51 +0,60</p> <p>1,40 mm Gasket + 0,61 +0,70</p>	

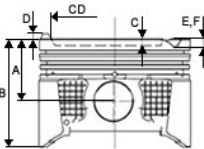

							
Engine	Ref. No. - Kit 1	Dimensions	Rings	Pin	Piston Liner	Kit 2	Info
<p>ø81,00</p> <p>4/6 Cyl. Diesel 2720cc 150 KW(204 PS) 2.7 Lion TVM 276DT PEUGEOT JAGUAR 2008 -....</p> <p>DISCOVERY 2.7 TDI RANGE ROVER 2.7 TDV6 2008 -</p>	<p>18-6592100 STD -mm 18-6592103 0,50 mm</p>	<p>A = 47,000 B = 71,000 C = 14,050 E = -0,500 F = -0,500 CD= 44,000</p> <p>Ring Carrier Oil Gallery</p>	<p>RE47570000 -STD RE47570050 -0,50</p> <p>2,000 (500) Cr PIF 2,000 (501) P IFU 2,000 (604) Nit S</p>	<p>ø29,0 x 62,0</p>			
							

Engine	Ref. No. - Kit 1	Dimensions	Rings	Pin	Piston Liner	Kit 2	Info
<p>ø71,50</p> <p>4 Cyl. Gasoline 1300 cc 75 Ps G4K <u>2000 -</u> Accent 1,3</p>	<p>18-4011060 STD -mm 18-4011063 0,50 mm</p>	<p>A = 30,800 B = 53,900 C = 0,700 E = -2,200 CD= 57,900</p>	<p>RJ40770A00 -STD - " ø18,0 RJ40770C00 -0,02 " x 47,5 RJ40770D00 -0,03 "</p> <p>1,500 () FV 1,500 () 3,000 ()</p>				
<p>ø75,50</p> <p>4 Cyl. Gasoline 1399 cc 97 PS 10:1 G4EE <u>2005 -</u> 1.4 DOCH AccentEra 1.4 16v</p>	<p>18-4011070 STD -mm 18-4011073 0,50 mm</p>	<p>A = 28,750 B = 47,900 D = 2,200 E = -2,950</p>	<p>RJ40112A00 -STD - " ø18,0 RJ40112C00 -0,02 " x 47,9</p> <p>1,200 () SV 1,200 () 2,000 () GN</p>				

							
Engine	Ref. No. - Kit 1	Dimensions	Rings	Pin	Piston Liner	Kit 2	Info
<p>ø83,00</p> <p>4 Cyl. Diesel 1493/1991 cc 60/82/100 Kw (82/112 Ps) 17.7:11 D3EA D4EA <u>2001 -</u></p> <p><i>Accent 1.5 CRDI Getz 1.5 CRDI Tuscon 2.0 CRDI Santa FE 2.0 CRDI Sportage 2. CRDI Carens 2.0 CRDI</i></p>	<p>18-4094540 STD -mm <i>18-4094540-20 STD -mm (0.2 mm SHORT)</i></p> <p>18-4094543 0,50 mm <i>18-4094543-20 0,50 mm (0.2 mm SHORT)</i></p>	<p>A = 46,300 B = 72,300 C = 13,900 CD= 46,950</p> <p>Ring Carrier Oil Cut-Out Bushing</p>	<p>RJ39597A00 -STD - " RJ39597C00 -0,02 "</p> <p>2,000 () 2,000 () 3,000 ()</p>				
<p>ø86,50</p> <p>4 Cyl. Diesel 2184 cc 22,9:1 R2 <u>1997 -....</u></p> <p><i>Besta Yeni Tip Crew Cap E 2200 Van/Pick Up</i></p>	<p>18-9050010 STD -mm 18-9050013 0,50 mm</p>	<p>A = 47,350 B = 86,150 C = 1,600</p> <p>Ring Carrier Oil Gallery Steel Support</p>	<p>RJ30855A00 -STD - " ø25,0 RJ30855C00 -0,02 " x 68,0</p> <p>2,000 () RN Cr1 FX 2,000 () 4,000 ()</p>				

Engine	Ref. No. - Kit 1	Dimensions	Rings	Pin	Piston Liner	Kit 2	Info
<p>ø86,50</p> <p>4 Sil 1984 cc 85 kW 115/116 PS 10,4:1 10,5:1 ,8 Ventile AEG APK AQY <u>1998-2008</u></p> <p><i>Besta Eski Model Crew Cap E2200 Van Pick Up</i></p>	<p>18-9050020 STD -mm 18-9050023 0,50 mm</p>	<p>A = 47,350 B = 86,150 C = 1,600</p> <p>Ring Carrier Steel Support</p>	<p>RJ30855A00 -STD - " ø25,0 RJ30855C00 -0,02 " x 68,0</p> <p>2,000 () RN Cr1 FX 2,000 () 4,000 ()</p>				
<p>ø91,00</p> <p>4 Cyl. Diesel 2497 cc 103 Kw (140 Ps) D4CB CRDI <u>2002 -....</u></p> <p><i>Starex 2.5 CRDI Sorento</i></p>	<p>18-4050050 STD -mm 18-4050053 0,50 mm</p>	<p>A = 54,250 B = 83,750 C = 15,000 E = -0,300 CD= 52,000</p> <p>Ring Carrier Oil Gallery Oil Cut-Out</p>	<p>RJ39613A00 -STD - " ø33,0 RJ39613C00 -0,02 " x 75,0</p> <p>2,500 () 2,000 () 3,000 ()</p>				<p>+ 0,06 + 0,24</p>

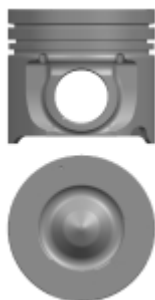

Engine	Ref. No. - Kit 1	Dimensions	Rings	Pin	Piston Liner	Kit 2	Info
<p>ø91,00</p> <p>4 Cyl. Diesel 2497 cc 125 Kw (170 BG) D4BC-..... Stratex 2.5 CRDI</p>	<p>18-4094900 STD -mm 18-4094903 0,50 mm</p>	<p>A = 54,250 B = 83,700 C = 15,000 E = -0,340 CD= 52,000</p> <p>Ring Carrier Oil Gallery Oil Cut-Out Bushing</p>	<p>RJ39613A00 -STD - " ϕ33,0 RJ39613C00 -0,02 " x 68,0</p> <p>2,500 () 2,000 () 3,000 ()</p>				
<p>ø91,10</p> <p>4 Cyl. Diesel 2467 cc 73 78 Kw (99 106) Ps D4BH 2000 -..... 2. & 4. Sil. Turbo Intercooler K2500 TCI Bongo Starex 2500 TCI</p>	<p>18-4050020 STD -mm 18-4050020-20 STD -mm (0.2 mm SHORT) 18-4050023 0,50 mm 18-4050023-20 0,50 mm (0.2 mm SHORT)</p>	<p>A = 48,700 B = 88,700 C = 1,300</p> <p>Ring Carrier Oil Gallery Steel Support</p>	<p>RJ40699A00 -STD - " ϕ29,0 RJ40699C00 -0,02 " x 75,0</p> <p>2,500 () RN FM 1,950 () RN 4,000 ()</p>				<p>+ 0,50 + 0,60</p>









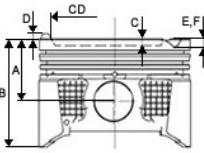

Engine	Ref. No. - Kit 1	Dimensions	Rings	Pin	Piston Liner	Kit 2	Info
<p>ø91,10</p> <p>4 Cyl. Diesel 2467 cc 73 78 Kw (99 106) Ps D4BH <u>2000 -....</u></p> <p>1. & 3. Sil. Turbo Intercooler K2500 TCI Bongo Starex 2500 TCI</p>	<p>18-4050030 STD -mm 18-4050030-20 STD -mm (0.2 mm SHORT)</p> <p>18-4050033 0,50 mm 18-4050033-20 0,50 mm (0.2 mm SHORT)</p>	<p>A = 48,700 B = 88,700 C = 1,300</p> <p>Ring Carrier Oil Gallery Steel Support</p>	<p>RJ40699A00 -STD - " ø29,0 RJ40699C00 -0,02 " x 75,0</p> <p>2,500 () RN FM 1,950 () RN 4,000 ()</p>				<p>+ 0,50 + 0,60</p>
<p>ø91,10</p>	<p>18-4050120 STD -mm</p>	<p>A = 48,700 B = 88,700 C = 3,200 E = -1,900 F = -2,500</p> <p>Steel Support</p>	<p>RJ40525A00 -STD - " ø29,0 RJ40525C00 -0,02 " x 77,0</p>				<p>1,45 mm Gasket + 0,562 + 0,620</p> <p>1,50 mm Gasket + 0,620 + 0,680</p> <p>1,55 mm Gasket + 0,680 + 0,774</p>

Engine	Ref. No. - Kit 1	Dimensions	Rings	Pin	Piston Liner	Kit 2	Info
<p>ø79,00</p> <p>4 Cyl. Gasoline 1600 cc</p> <p>1.6 Ecoboost</p> <p>..... -</p> <p>1.6 EcoBoost</p>	<p>18-2510440 STD -mm 18-2510440-20 STD -mm (0.2 mm SHORT)</p> <p>18-2510443 0,50 mm 18-2510443-20 0,50 mm (0.2 mm SHORT)</p>	<p>A = 28,300 B = 54,200 C = 5,000 CD= 53,500</p> <p>Hard Anodising</p>	<p>RE43490000 -STD RE43490050 -0,50 RE43490100 -1,00</p> <p>1,200 (500) NitB S 1,200 (501) P 2,000 (700) Cr P S</p>	<p>ø21,0 x 46,0</p>			
<p>ø80,00</p> <p>4 Cyl. Gasoline 1796 cc 107/110 kW (146 150 PS) 10.5:1 18 K4K VVC 18 K4F K Series 18 K4F <u>11/95 - 05/05</u></p> <p>25 1.8 16v 200 218 K Vi 400 Tourer 1.8i Coupe 1.8 16V Freelander (1.8 16V 1.8 i 16V Soft Top 1.8 Soft Top 1.8 i (16V) Elise 1.8 Seven 1.8 MGF (1.6-1.8)</p>	<p>18-6510080 STD -mm 18-6510083 0,50 mm</p>	<p>A = 22,700 B = 45,650 C = 0,530 E = -2,650 CD= 68,200</p>	<p>RE70050000 -STD RE70050050 -0,50</p> <p>1,000 (500) Nit S IF 1,200 (508) P 2,000 (700) Nit S</p>	<p>ø18,0 x 53,0</p>			

Engine	Ref. No. - Kit 1	Dimensions	Rings	Pin	Piston Liner	Kit 2	Info
<p>ø80,00</p> <p>4/6 Cyl. Diesel 1669/2498 cc 105 Kw (90/143 Ps) M41 M51 D25WA BMW <u>1990 -....</u></p> <p>Turbo Intercooler 318 Compact TDS/TouringSE 325 325/525 TDS/Touring 725 TDS Omega TDS Range Rover</p>	<p>18-6592090 STD -mm 18-6592093 0,50 mm</p>	<p>A = 39,450 B = 62,450 C = 2,500</p> <p>Ring Carrier Oil Gallery Steel Support Oil Cut-Out</p>	<p>RE15140000 -STD RE15140050 -0,50 RE15140100 -1,00</p> <p>3,000 (504) Cr 1,750 (501) P IFU 3,000 (604) Cr</p>	<p>ø27,0 x 63,0</p>			
<p>ø81,00</p> <p>4/6 Cyl. Diesel 2720cc 150 KW(204 PS) 2.7 Lion TVM 276DT PEUGEOT JAGUAR <u>2008 -....</u></p> <p>DISCOVERY 2.7 TDI RANGE ROVER 2.7 TDV6 2008 -</p>	<p>18-6592100 STD -mm 18-6592103 0,50 mm</p>	<p>A = 47,000 B = 71,000 C = 14,050 E = -0,500 F = -0,500 CD= 44,000</p> <p>Ring Carrier Oil Gallery</p>	<p>RE47570000 -STD RE47570050 -0,50</p> <p>2,000 (500) Cr PIF 2,000 (501) P IFU 2,000 (604) Nit S</p>	<p>ø29,0 x 62,0</p>			

Engine	Ref. No. - Kit 1	Dimensions	Rings	Pin	Piston Liner	Kit 2	Info
<p>ø84,00</p> <p>6 Cyl. Diesel 2993 cc 155 KW 150 HP 3.0L AJD V6 DT20 <u>2010 -....</u> DISCOVERY IV</p>	<p>18-6592220 STD -mm 18-6592223 0,50 mm</p>	<p>A = 46,000 B = 70,000 C = 15,350 CD= 47,620</p> <p>Ring Carrier Oil Gallery Oil Cut-Out</p>	<p>RE35010000 -STD RE35010050 -STD</p> <p>1,750 (500) Cr S 1,750 (501) P IFU 2,000 (604) Nit S</p>	<p>ø30,0 x 63,7</p>			
<p>ø84,00</p> <p>4/6 Cyl. Diesel 2926 cc 135 Kw (184 Ps) M57D30 M47D20R TD6 <u>1999 -....</u> Freelander Range Rover TD6 2002</p>	<p>18-6592960 STD -mm 18-6592963 0,50 mm</p>	<p>A = 47,000 C = 16,500 E = -1,360 F = -1,480 G = 71,000 CD= 41,550</p> <p>Ring Carrier Oil Gallery</p>	<p>RE15410000 -STD RE15410050 -0,50</p> <p>3,000 (504) Cr 2,000 (508) P 3,000 (604) Nit S</p>	<p>ø30,0 x 68,0</p>			<p>1. Notch Gasket +0,80 +0,90</p> <p>2. Notch Gasket +0,90 +1,00</p>

							
Engine	Ref. No. - Kit 1	Dimensions	Rings	Pin	Piston Liner	Kit 2	Info
<p>ø84,45</p> <p>4 Cyl. Diesel 1944 cc 74/83/63/72 kW 86/113 PS 20T2N (L Series) 20T2R (L Series) Turbo Intercooled <u>12/94 - 10/06</u></p> <p>25-40 2.0i DT 220 SD 220 SDI 420 SD 420 SDI 620 SDI Streetwise 2.0 TD Freelander (Soft Top) 2.0DI Accord V-VI 2.0 TDi Civic VI 2.0 TDiC (Aerodeck) D-TDiC MG ZR/ZS 2.0 Express 2.0 TD</p>	<p>18-6550900 STD -mm 18-6550903 0,50 mm</p> 	<p>A = 47,970 B = 76,970 C = 17,000 CD= 38,000</p> <p>Ring Carrier</p>	<p>RE70070000 -STD RE70070050 -0,50</p> <p>3,000 (504) Cr P2 (508)P 3,000 (604) Cr P S</p>	<p>ø30,0 x 70,0</p>			
<p>ø84,45</p> <p>5 Cyl. Diesel 2495 cc 90 102 Kw TD5 Range Rover <u>1998 -....</u></p> <p>Discovery 2.5 TD5 Adventurer Discovery 1994></p>	<p>18-6592980 STD -mm 18-6592983 0,50 mm</p>	<p>A = 47,850 B = 79,000 C = 17,400 CD= 39,000</p> <p>Ring Carrier Oil Gallery</p>	<p>RE35020000 -STD RE35020050 -STD</p> <p>3,000 (503) Cr S 2,000 (508) P 3,000 (604) Cr P S</p>	<p>ø30,0 x 70,0</p>			

Engine	Ref. No. - Kit 1	Dimensions	Rings	Pin	Piston Liner	Kit 2	Info
<p>ø85,00</p> <p>4 Cyl. Diesel 2179 cc 110 KW 211 PS DW12BTED4 <u>2011 - 2013</u> FREELANDER 2 2.2 TD4</p>	<p>18-6592300 STD -mm 18-6592303 0,50 mm</p>	<p>A = 48,705 B = 74,705 C = 13,475 E = -0,385 CD= 52,400</p> <p>Ring Carrier Oil Gallery Oil Cut-Out</p>	<p>RE35000000 -STD RE35000050 -0,50</p> <p>2,500 (505) Cr P 2,000 (501) P IFU 2,000 (604) Nit S</p>	<p>ø30,0 x 68,0</p>			
<p>ø85,00</p> <p>4 Cyl. Diesel 2179 cc 110 KW 150 HP DW12BTED4 PEUGEOT COMMON ENGINE <u>2010 -....</u> Freelander 2 2.2 TD4 2010</p>	<p>14-6592990 STD -mm 14-6592993 0,50 mm</p>	<p>A = 48,705 B = 74,705 C = 13,475 E = -0,385 CD= 52,400</p> <p>Ring Carrier Oil Gallery Oil Cut-Out</p>	<p>RE35000000 -STD RE35000050 -0,50</p> <p>2,500 (505) Cr P 2,000 (501) P IFU 2,000 (604) Nit S</p>	<p>ø30,0 x 68,0</p>			

Engine	Ref. No. - Kit 1	Dimensions	Rings	Pin	Piston Liner	Kit 2	Info
<p>ø90,48</p> <p>4 Cyl. Diesel 2486 cc 83 Kw (113 Ps) 19,3:1 300 TDi <u>1994 -....</u> Defender 110 Defender 130 Defender 90 1994</p>	<p>14-6593010 STD -mm 14-6593013 0,50 mm 14-6593018 1,00 mm</p>	<p>A = 55,400 B = 92,000 C = 18,450 CD= 39,000</p> <p>Ring Carrier</p>	<p>RE35050000 -STD RE35050050 -0,50 RE35050100 -1,00</p> <p>3,000 (505) Mo 2,500 (508) P 3,000 (604) Cr P</p>	<p>ø30,2 x 77,0</p>			<p>1. Notch Gasket + 0,50 + 0,60</p> <p>2. Notch Gasket + 0,61 + 0,70</p> <p>3. Notch Gasket + 0,71 + 0,80</p>





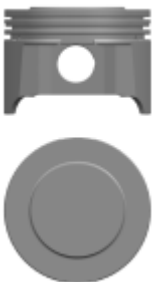



Engine	Ref. No. - Kit 1	Dimensions	Rings	Pin	Piston Liner	Kit 2	Info
<p>ø71,91</p> <p>R 4 Petrol, 1242 cm³ 55 kW (75 hp) ZtecS DHA DHB DHC DHD DHE DHF DHG <u>1997-2001</u> <i>Fiesta 1.2 16v Focus 1.2 16v Mazda 121</i></p>	<p>18-2510860 STD -mm 18-2510863 0,50 mm</p>	<p>A = 28,250 B = 53,250 C = 0,930 CD= 52,000</p>	<p>RE23480000 -STD RE23480050 -0,50</p> <p>1,200 (500) CrB P S IF 1,500 (508) P 2,500 (700) Cr P S</p>	<p>ø19,0 x 50,0</p>			
<p>ø73,70</p> <p>4 Cyl. Diesel 1399 cc 50 Kw (68 Ps) DV4TD DV4 TED DV4C TED F6JA F6JB 8HX 8HR 8HZ 8HS <u>2002 -....</u> <i>Fiesta V 1.4 TDCI Fusion 1.4 TDCI Mazda 2 1,4D C2 1.4 HDI C3 1.4 HDI XSARA 1. 4 HDI NEMO 1.4 HDI 1007 1.4 HDI 107 1.4 HDI 206 1.4 HDI 207 1.4 HDI 307 1.4 HDI BIPPER 1.4 HDI</i></p>	<p>18-2550150 STD -mm 18-2550150-20 STD -mm (0.2 mm SHORT) 18-2550150-40 STD -mm (0.4 mm SHORT) 18-2550153 0,50 mm 18-2550153-20 0,50 mm (0.2 mm SHORT) 18-2550153-40 0,50 mm (0.4 mm SHORT)</p>	<p>A = 42,940 B = 65,440 C = 14,700 CD= 37,200</p> <p>Ring Carrier</p>	<p>RE23050000 -STD RE23050050 -0,50</p> <p>2,500 (505) CrB P 1,950 (508) P IFU 2,500 (604) Cr P</p>	<p>ø25,0 x 60,0</p>			



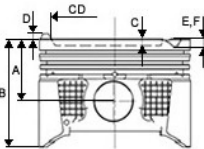









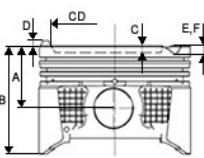





Engine	Ref. No. - Kit 1	Dimensions	Rings	Pin	Piston Liner	Kit 2	Info
<p>ø73,94</p> <p>R 4 Petrol, 1297 cm³ 44 kW (60 hp)</p> <p>J4C J4D J4J J4K J4L J4M J4N J4P J4Q J4R J4S J4T JB</p> <p><u>1988-1992</u></p> <p><i>Escort IV 1.3</i> <i>Fiesta IV 1.3</i></p>	<p>18-2510770 STD -mm 18-2510773 0,50 mm 18-2510778 1,00 mm</p> 	<p>A = 29,400 B = 53,900</p>	<p>RE23010000 -STD RE23010050 -0,50 RE23010100 -1,00</p> <p>1,500 (500) Cr S IF 1,750 (508) P 3,000 (700) Cr P S</p>	<p>ø18,0 x 64,0</p>			
<p>ø76,00</p> <p>4 Cyl. Gasoline 1400cc 80 Ps</p> <p>FXDA FXDB FXDC FXJA FXJB</p> <p><u>2002 - 2011</u></p> <p><i>Fiesta 1.4</i> <i>Puma 1.4</i> <i>Mazda 2 1,4i 16v</i> <i>Mazda 3 1,4i 16v</i></p>	<p>18-2510870 STD -mm 18-2510873 0,50 mm</p> 	<p>A = 28,250 B = 55,500 D = 1,250</p>	<p>RE23540000 -STD RE23540050 -0,50</p> <p>1,200 (500) NitB S 1,500 (501) P 2,500 (700) Nit S</p>	<p>ø19,0 x 50,0</p>			



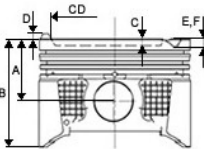



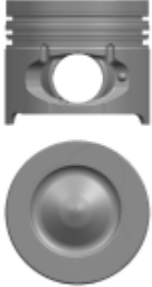
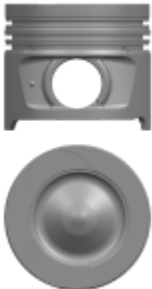

Engine	Ref. No. - Kit 1	Dimensions	Rings	Pin	Piston Liner	Kit 2	Info
<p>ø82,50</p> <p>R 4 Diesel, 1753 cm³ 44 kW (60 hp), 21,5:1</p> <p>RTA RTB RTC RTD RTE RTF RTG RTH RTJ</p> <p><u>1988-1994</u></p> <p><i>Fiesta D Escort D Orion D Mazda 121 1,8D</i></p>	<p>18-2550910 STD -mm 18-2550913 0,50 mm</p>	<p>A = 45,700 B = 73,700 C = 1,600</p> <p>Ring Carrier</p>	<p>RE43150000 -STD RE43150050 -0,50 RE43150100 -1,00</p> <p>2,000 (500) Cr 2,000 (501) P 3,000 (604) Cr</p>	<p>ø26,0 x 69,0</p>			
<p>ø86,50</p> <p>4 Cyl. Diesel 2184 cc 22,9:1</p> <p>R2</p> <p><u>1997-.....</u></p> <p><i>Besta Yeni Tip Crew Cap E 2200 Van/Pick Up</i></p>	<p>18-9050010 STD -mm 18-9050013 0,50 mm</p>	<p>A = 47,350 B = 86,150 C = 1,600</p> <p>Ring Carrier Oil Gallery Steel Support</p>	<p>RJ30855A00 -STD -" RJ30855C00 -0,02 " "</p> <p>2,000 () RN Cr1 FX 2,000 () 4,000 ()</p>	<p>ø25,0 x 68,0</p>			

Engine	Ref. No. - Kit 1	Dimensions	Rings	Pin	Piston Liner	Kit 2	Info
<p>ø86,50</p> <p>4 Sil 1984 cc 85 kW 115/116 PS 10,4:1 10,5:1 ,8 Ventile AEG APK AQY <u>1998-2008</u></p> <p><i>Besta Eski Model Crew Cap E2200 Van Pick Up</i></p>	<p>18-9050020 STD -mm 18-9050023 0,50 mm</p>	<p>A = 47,350 B = 86,150 C = 1,600</p> <p>Ring Carrier Steel Support</p>	<p>RJ30855A00 -STD - RJ30855C00 -0,02 "</p> <p>2,000 () RN Cr1 FX 2,000 () 4,000 ()</p>	<p>ø25,0 x 68,0</p>			
<p>ø87,50</p> <p>4 Cyl. Gasoline 2000cc 145 Ps HE DURATEC <u>2001....</u></p> <p><i>Mondeo 2,0 Mazda 6 2,0i 16v Atenza 2,0i 16v</i></p>	<p>18-2510310 STD -mm 18-2510313 0,50 mm</p>	<p>A = 28,400 B = 51,000 C = 0,350 CD= 75,400</p>	<p>RE23470000 -STD RE23470050 -0,50</p> <p>1,200 (500) Cr4B S 1,200 (501) P IFU 2,500 (700) Cr P S</p>	<p>ø21,0 x 60,0</p>			

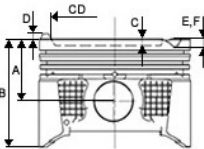
							
Engine	Ref. No. - Kit 1	Dimensions	Rings	Pin	Piston Liner	Kit 2	Info
<p>ø93,00</p> <p>4 Cyl. Diesel 2500 cc 79 Ps XM34 WLOHC (1997 2004)</p> <p><i>Ranger Pick Up B2500 Pick Up</i></p>	<p>18-2581980 STD -mm 18-2581983 0,50 mm</p>	<p>A = 47,800 B = 87,400 C = 1,200</p> <p>Ring Carrier Steel Support</p>	<p>RJ30175A00 -STD - " ø32,0 RJ30175B00 -0,015 "x 68,0 RJ30175C00 -0,02 "</p> <p>2,500 () FX 2,000 () 3,000 ()</p>				
<p>ø93,00</p> <p>4 Cyl. Diesel 2500 cc 110 Ps XM34TD XM34TD/WL T</p> <p><u>1998 -</u></p> <p><i>Ranger Pick Up Thunder, Ranger Pick Up XLT B2500 TD Ranger</i></p>	<p>18-2582990 STD -mm 18-2582993 0,50 mm</p>	<p>A = 47,850 B = 87,350 C = 2,100</p> <p>Ring Carrier Oil Gallery Steel Support Oil Cut-Out</p>	<p>RJ30175A00 -STD - " ø32,0 RJ30175B00 -0,015 "x 68,0 RJ30175C00 -0,02 "</p> <p>2,500 () FX 2,000 () 3,000 ()</p>				

							
Engine	Ref. No. - Kit 1	Dimensions	Rings	Pin	Piston Liner	Kit 2	Info
<p>ø93,00</p> <p>4 Cyl. Diesel 2499cc 143 PS 6M34 WL C <u>2006 -</u> Ranger Pickup TDCI</p>	<p>18-2584020 STD -mm 18-2584023 0,50 mm</p>	<p>A = 51,750 B = 81,300 C = 15,100 CD= 48,500</p> <p>Ring Carrier Oil Gallery</p>	<p>RJ30004A00 -STD - " ø34,0 RJ30004C00 -0,02 " x 70,0</p> <p>2,000 () GN SM 1,500 () RN 2,000 () GN</p>				<p>STDGasket +0,08 +0,15</p> <p>1 Notch Gasket +0,13 +0,25</p> <p>2 Notch Gasket +0,20 +0,31</p>







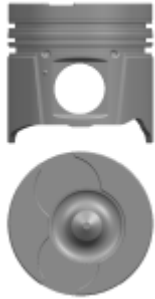

							
Engine	Ref. No. - Kit 1	Dimensions	Rings	Pin	Piston Liner	Kit 2	Info
<p>ø76,00</p> <p>4 Cyl. Diesel 1461cc 65 KW 90 HP K9K Euro5 OM607</p> <p><u>2010 -....</u></p> <p><i>Grand Scenic III 1.5DCI 16V Megane Grandtour III 1.5dCi Megane III 1.5dCi Citane 108/109 A 160 CDi B160 CDi</i></p> 	<p>18-8050840 STD -mm <i>18-8050840-20 STD -mm (0.2 mm SHORT)</i></p> <p>18-8050843 0,50 mm <i>18-8050843-20 0,50 mm (0.2 mm SHORT)</i></p> <p>18-8050848 1,00 mm <i>18-8050848-20 1,00 mm (0.2 mm SHORT)</i></p>	<p>A = 41,667 B = 66,000 C = 13,500 D = 0,430 E = -0,250 CD= 47,000</p> <p>Ring Carrier Oil Cut-Out</p>	<p>RE49400000 -STD RE49400050 -0,50 RE49400100 -1,00</p> <p>2,000 (500) CKP 2,000 (501) P 2,500 (604) CrP</p>	<p>ø26,0 x 60,0</p>			
<p>ø76,00</p> <p>4 Cyl. Diesel 1461cc 81KW 110HP 15.5:1 K9K 837/846 EURO5 (2010>) OM607 (2013>)</p> <p><u>2010>2013></u></p> <p><i>Grand Secnic III 1.5DCI 16V Megane Grandtour III 1.5dCi Megane III 1.5dCi Citane 111 CLA 180 CDi GLA 180 CDi A180 CDi B180 CDi</i></p> 	<p>18-8092830 STD -mm 18-8092833 0,50 mm</p>	<p>A = 41,667 B = 66,000 C = 13,500 E = -0,430 F = -0,250 CD= 47,000</p> <p>Ring Carrier Oil Gallery Oil Cut-Out</p>	<p>RE49400000 -STD RE49400050 -0,50 RE49400100 -1,00</p> <p>2,000 (500) CKP 2,000 (501) P 2,500 (604) CrP</p>	<p>ø26,0 x 60,0</p>			



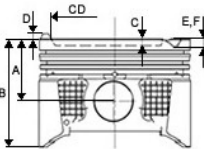





							
Engine	Ref. No. - Kit 1	Dimensions	Rings	Pin	Piston Liner	Kit 2	Info
<p>ø80,00</p> <p>4 Cyl. Diesel 1598cc 96 KW 130PS R9M 402 <u>2015 -</u> Qashgai (2015 -)</p>	<p>18-8092820 STD -mm 18-8092823 0,50 mm</p>	<p>A = 46,000 B = 70,500 C = 12,350 E = -0,300 CD= 46,500</p> <p>Ring Carrier Oil Gallery Oil Cut-Out</p>	<p>RE49510000 -STD RE49510050 -0,50</p> <p>2,000 (500) Cpk 1,750 (501) P IFU 2,000 (604) Cr P</p>	<p>ø30,0 x 60,0</p>			
<p>ø80,00</p> <p>4 Cyl. Diesel 1900 cc 81/97Kw 110/132 Ps F9Q 266/759/803/804-..... MEGANE II 1.9 dCi SCENIC II J 1.9dCi</p>	<p>18-8092950 STD -mm 18-8092953 0,50 mm</p>	<p>A = 47,004 B = 77,000 C = 17,800 E = -0,850 F = -0,850 CD= 40,000</p> <p>Ring Carrier Oil Gallery Oil Cut-Out</p>	<p>RE49380000 -STD RE49380050 -0,50</p> <p>2,500 (500) CKP 2,000 (501) P 3,000 (604) Cr</p>	<p>ø28,0 x 60,0</p>			



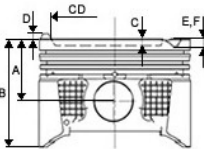









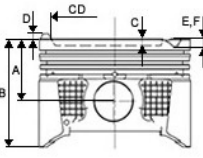





Engine	Ref. No. - Kit 1	Dimensions	Rings	Pin	Piston Liner	Kit 2	Info
<p>ø80,01</p> <p>4 Cyl. Diesel 1870cc 66/81/88 Kw (95/110/120 Ps) F9Q (650/664/670 674/750/756/758 756/812/816/818 808/820/826 <u>1999 - 2009</u></p> <p><i>Megane/Laguna II 1.9 dCi Grandtour II 1.9 dCi Scenic/Clio III 1.9 dCi Megane Grandtour 1.9 dCi Grand Scenic II 1.9 dCi Espace IV 1.9 dCi</i></p>	<p>18-8092930 STD -mm 18-8092933 0,50 mm</p>	<p>A = 47,040 B = 77,000 C = 17,800 E = -0,750 CD= 38,000</p> <p>Ring Carrier Oil Gallery Oil Cut-Out</p>	<p>RE49380000 -STD RE49380050 -0,50</p> <p>2,500 (500) CKP 2,000 (501) P 3,000 (604) Cr</p>	<p>ø28,0 x 60,0</p>			
<p>ø82,00</p> <p>4 Cyl. Gasoline 1796 cc 156 184 Ps M271 1.6 180PS <u>2007-.....</u></p> <p><i>MERCEDES BENZ C 180 CGI-2007</i></p>	<p>14-5010110 STD -mm 14-5010113 0,50 mm</p>	<p>A = 29,900 B = 50,900 C = 1,000 E = -4,000 F = -1,000 CD= 70,000</p>	<p>RE40090000 -STD RE40090050 -0,50</p> <p>1,200 (500) NitB S 1,500 (501) P 2,500 (700) Nit S</p>	<p>ø20,0 x 56,0</p>			



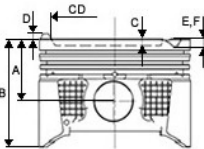







							
Engine	Ref. No. - Kit 1	Dimensions	Rings	Pin	Piston Liner	Kit 2	Info
<p>ø82,00</p> <p>4 Cyl. Gasoline 1796cc 141 Kw (192 Ps) M271E18948 <u>2001 - 2005</u></p> <p>MERCEDES BENZ C200 C230 CLK200 E200 Komp.-2001-2005</p>	<p>14-5010120 STD -mm 14-5010123 0,50 mm</p>	<p>A = 29,900 B = 50,900 C = 4,610 E = -1,000 F = -4,000 CD= 71,200</p> <p>Hard Anodising</p>	<p>RE40090000 -STD RE40090050 -0,50</p> <p>1,200 (500) NitB S 1,500 (501) P 2,500 (700) Nit S</p>	<p>ø20,0 x 56,0</p>			
<p>ø83,00</p> <p>6 Cyl. 2987 cc 155/165 Kw (211 224 Ps) 17,7:1 OM 642/910/642/920 642/921/642/930 642/932/642/940/642 950/642/960/642/961 642/970 Dizel <u>2005 - 2009</u></p> <p>Piston Sol. C 350 CDI (204)</p>	<p>14-5092060 STD -mm</p>	<p>A = 45,650 B = 71,650 C = 15,510 E = -1,430 F = -1,070 CD= 51,100</p> <p>Ring Carrier Oil Gallery Oil Cut-Out</p>	<p>RE40140000 -STD RE40140050 -0,50</p> <p>2,000 (504) Cr P IF 2,000 (501) P IFU 2,000 (604) Cr P</p>	<p>ø33,0 x 66,0</p>			<p>+0,53 +0,77</p>



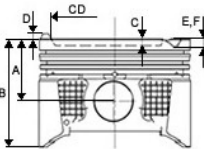





							
Engine	Ref. No. - Kit 1	Dimensions	Rings	Pin	Piston Liner	Kit 2	Info
<p>ø83,00</p> <p>6 Cyl. 2987 cc 155/165 Kw (211 224 Ps) 17,7:1 OM 642/910/642/920 642/921/642/930 642/932/642/940/642 950/642/960/642/961 642/970 Dizel <u>2005 - 2009</u></p> <p><i>Piston Sağ. C 350 CDI (204)</i></p>	<p>14-5092070 STD -mm</p>	<p>A = 45,650 B = 71,650 C = 15,510 E = -1,430 F = -1,070 CD= 51,100</p> <p>Ring Carrier Oil Gallery Oil Cut-Out</p>	<p>RE40140000 -STD RE40140050 -0,50</p> <p>2,000 (504) Cr P IF 2,000 (501) P IFU 2,000 (604) Cr P</p>	<p>ø33,0 x 66,0</p>			<p>+0,53 +0,77</p>
<p>ø83,00</p> <p>6 Cyl. 2987 cc 155/165 Kw (211 224 Ps) 17,7:1 OM 642/910/642/920 642/921/642/930 642/932/642/940/642 950/642/960/642/961 642/970 Dizel <u>2005 - 2009</u></p> <p><i>Piston Sol. CLS 320 CDI E 280 CDI E 300 Bluetec, E 320 CDI</i></p>	<p>14-5092080 STD -mm</p>	<p>A = 45,650 B = 71,650 C = 14,650 E = -1,330 F = -1,490 CD= 43,400</p> <p>Ring Carrier Oil Gallery Oil Cut-Out</p>	<p>RE40140000 -STD RE40140050 -0,50</p> <p>2,000 (504) Cr P IF 2,000 (501) P IFU 2,000 (604) Cr P</p>	<p>ø30,0 x 66,0</p>			<p>+0,53 +0,77</p>



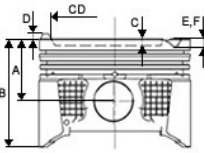





							
Engine	Ref. No. - Kit 1	Dimensions	Rings	Pin	Piston Liner	Kit 2	Info
<p>ø83,00</p> <p>6 Cyl. 2987 cc 155/165 Kw (211 224 Ps) 17,7:1 OM 642/910/642/920 642/921/642/930 642/932/642/940/642 950/642/960/642/961 642/970 Dizel <u>2005 - 2009</u></p> <p><i>Piston Sağ, CLS 320 CDI E 280 CDI E 300 Bluetec, E 320 CDI</i></p>	<p>14-5092090 STD -mm</p>	<p>A = 45,650 B = 71,650 C = 14,650 E = -1,330 F = -1,490 CD= 43,400</p> <p>Ring Carrier Oil Gallery Oil Cut-Out</p>	<p>RE40140000 -STD RE40140050 -0,50</p> <p>2,000 (504) Cr P IF 2,000 (501) P IFU 2,000 (604) Cr P</p>	<p>ø30,0 x 66,0</p>			<p>+0,53 +0,77</p>
<p>ø83,00</p> <p>6 Cyl. Diesel 2987 cc 155 Kw 210 Ps OM 642.820 <u>2010 -</u></p> <p><i>1.2.3. Sll, GL 320 CDI GL 350 CDI ML 300 CDI ML 320 CDI ML 350 CDI</i></p>	<p>14-5092100 STD -mm</p>	<p>A = 45,650 B = 71,650 C = 14,650 E = -1,430 F = -1,070 CD= 43,400</p> <p>Ring Carrier Oil Gallery Oil Cut-Out</p>	<p>RE40140000 -STD RE40140050 -0,50</p> <p>2,000 (504) Cr P IF 2,000 (501) P IFU 2,000 (604) Cr P</p>	<p>ø30,0 x 66,0</p>			



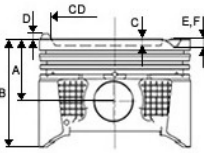





							
Engine	Ref. No. - Kit 1	Dimensions	Rings	Pin	Piston Liner	Kit 2	Info
<p>ø83,00</p> <p>4 Cyl. Diesel 1991cc 80 Kw (109 Ps) 18:1 OM 640.940 941 942 A160 180 200CDI <u>2004 -....</u></p> <p>MERCEDES BENZ Turbo Intercooler 16 v C.Rail A 180 CDI B 180 CDI</p>	<p>14-5092130 STD -mm 14-5092133 0,50 mm</p>	<p>A = 45,650 B = 71,650 C = 14,650 E = -1,180 F = -1,020 CD= 43,400</p> <p>Ring Carrier Oil Gallery Oil Cut-Out</p>	<p>RE40140000 -STD RE40140050 -0,50</p> <p>2,000 (504) Cr P IF 2,000 (501) P IFU 2,000 (604) Cr P</p>	<p>ø30,0 x 66,0</p>			
<p>ø83,00</p> <p>6 Cyl. Diesel 2987 cc 155 Kw 210 Ps OM 642.820 <u>2010 -....</u></p> <p>4,5,6,Sil. GL 320 CDI GL 350 CDI ML 300 CDI ML 320 CDI ML 350 CDI</p>	<p>14-5092200 STD -mm</p>	<p>A = 45,650 B = 71,650 C = 14,650 E = -1,430 F = -1,070 CD= 43,400</p> <p>Ring Carrier Oil Gallery Oil Cut-Out</p>	<p>RE40140000 -STD RE40140050 -0,50</p> <p>2,000 (504) Cr P IF 2,000 (501) P IFU 2,000 (604) Cr P</p>	<p>ø30,0 x 66,0</p>			



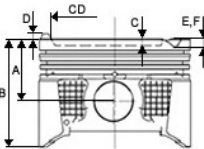





Engine	Ref. No. - Kit 1	Dimensions	Rings	Pin	Piston Liner	Kit 2	Info
<p>ø87,00</p> <p>4 Cyl. Gasoline 1988cc 62/70 KW 85/95PS M115.923/926/938/939 <u>1968 - 1980</u></p> <p>200 220</p>	<p>18-5010230 STD -mm 18-5010233 0,50 mm 18-5010238 1,00 mm</p>	<p>A = 52,400 B = 84,400</p> <p>Steel Support</p>	<p>RE40110000 -STD RE40110050 -0,50 RE40110100 -1,00</p> <p>1,750 (500) Cr S IF 2,500 (508) P 4,000 (604) Cr P</p>	<p>ø26,0 x 72,0</p>			
<p>ø87,00</p> <p>5 Cyl. Diesel 2496 cc 90 93 Kw (122 126 Ps) OM602A 2.5 D TD <u>1988 - 1995</u></p> <p>MERCEDES BENZ 190 D 2.5 250 D Turbo E 250 TD 1988 - 1995</p>	<p>14-5095880 STD -mm 14-5095883 0,50 mm</p>	<p>A = 44,850 B = 74,850 C = 9,100 E = -1,050 F = -1,250</p> <p>Ring Carrier Hard Anodising Oil Gallery</p>	<p>RE40160000 -STD RE40160050 -0,50 RE40160100 -1,00</p> <p>2,500 (500) Cr 2,000 (501) P IF 3,000 (604) Cr P</p>	<p>ø28,0 x 70,0</p>			<p>+ 0,73 + 0,96</p>



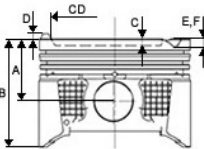





							
Engine	Ref. No. - Kit 1	Dimensions	Rings	Pin	Piston Liner	Kit 2	Info
<p>ø88,00</p> <p>4 Cyl. Diesel 2151 cc 85 105 Kw OM 611 DE 22LA <u>1998 - 2003</u></p> <p>MERCEDES BENZ C200/220 CDI E200/220 CDI</p>	<p>14-5092110 STD -mm 14-5092113 0,50 mm 14-5092118 1,00 mm</p>	<p>A = 42,300 B = 72,300 C = 13,800 E = -1,900 F = -2,400 CD= 43,500</p> <p>Ring Carrier Oil Gallery</p>	<p>RE40770000 -STD RE40770050 -0,50 RE40770100 -1,00</p> <p>2,500 (500) Cr P IF 2,000 (501) P IF 3,000 (604) Cr P</p>	<p>ø30,0 x 70,0</p>			<p>+ 0,38 + 0,62</p>
<p>ø88,00</p> <p>4 Cyl. Diesel 2151 cc 85 105 Kw OM 612.963 981 Euro 3 %20 DÜŞÜK KOMPRESYON <u>1998 - 2003</u></p> <p>MERCEDES BENZ C270 CDI E270 CDI ML270 CDI 4X4</p>	<p>14-5092120 STD -mm</p>	<p>A = 42,300 B = 72,300 C = 13,800 E = -1,900 F = -2,400 CD= 43,500</p> <p>Ring Carrier Oil Gallery</p>	<p>RE40770000 -STD RE40770050 -0,50 RE40770100 -1,00</p> <p>2,500 (500) Cr P IF 2,000 (501) P IF 3,000 (604) Cr P</p>	<p>ø30,0 x 70,0</p>			<p>+ 0,38 + 0,62</p>



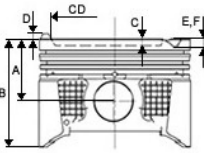



							
Engine	Ref. No. - Kit 1	Dimensions	Rings	Pin	Piston Liner	Kit 2	Info
<p>ø88,00</p> <p>4 Cyl. Diesel 2151 cc 85 115 Kw OM 611 DE 22LA <u>1996 - 2000</u></p> <p>MERCEDES BENZ C 200 CDI C 220 CDI E 200 CDI E 220 CDI</p>	<p>14-5092140 STD -mm 14-5092143 0,50 mm</p>	<p>A = 42,300 B = 72,300 C = 13,300 E = -1,910 F = -2,420 CD= 43,100</p> <p>Ring Carrier Oil Gallery</p>	<p>RE40770000 -STD RE40770050 -0,50 RE40770100 -1,00</p> <p>2,500 (500) Cr P IF 2,000 (501) P IF 3,000 (604) Cr P</p>	<p>ø28,0 x 70,0</p>			<p>+ 0,38 + 0,62</p>
<p>ø88,00</p> <p>4 Cyl. Diesel 2150cc 65/80/95/110 Kw (88/109/129/150 Ps OM 646 986 C.Rail Euro 4 <u>2007 -....</u></p> <p>MERCEDES BENZ Sprinter 209CDI 211CDI 213CDI 215CDI</p>	<p>14-5094110 STD -mm 14-5094113 0,50 mm</p>	<p>A = 42,400 B = 72,300 C = 14,100 E = -2,030 F = -1,780 CD= 46,000</p> <p>Ring Carrier Oil Gallery Oil Cut-Out</p>	<p>RE40580000 -STD RE40580050 -0,50</p> <p>2,500 (xxx) CKS 2,000 (xxx) CR 2,000 (xxx) CR</p>	<p>ø30,0 x 70,0</p>			<p>+0,38 +0,62</p>

							
Engine	Ref. No. - Kit 1	Dimensions	Rings	Pin	Piston Liner	Kit 2	Info
<p>ø88,50</p> <p>6 Cyl. Gasoline 2962 cc 126 140 Kw M103 E30.981 982 983 985</p> <p><u>1985 - 1992</u></p> <p>MERCEDES Injection Catal.Conv.300 E 300 GE</p>	<p>14-5010130 STD -mm 14-5010133 0,50 mm 14-5010138 1,00 mm</p>	<p>A = 33,000 B = 63,000 C = 2,700 E = -0,820 F = -2,020</p> <p>Steel Support</p>	<p>RE40190000 -STD RE40190050 -0,50</p> <p>1,500 (500) Nit S IF 1,750 (508) P 3,000 (604) Cr P</p>	<p>ø22,0 x 52,0</p>			
<p>ø89,00</p> <p>4 Cyl. Gasoline 1997 cc 80 87 Kw M102 E20.962 963 965</p> <p><u>1984 - 1993</u></p> <p>MERCEDES BENZ 190E 200E 200GE 1984 - 1993</p>	<p>14-5010140 STD -mm 14-5010143 0,50 mm 14-5010148 1,00 mm</p>	<p>A = 42,380 B = 74,700 D = 3,850 E = -2,530</p> <p>Steel Support</p>	<p>RE40200000 -STD RE40200050 -0,50 RE40200100 -1,00</p> <p>1,750 (500) Cr S IF 2,000 (508) P 3,500 (604) Cr P</p>	<p>ø22,0 x 56,0</p>			

							
Engine	Ref. No. - Kit 1	Dimensions	Rings	Pin	Piston Liner	Kit 2	Info
<p>ø89,00</p> <p>4 Cyl. Gasoline 1997cc 87/63/72/74 KW 118/86/98/100PS M102E20.962 1984 > M102V20.938 1983 > M102V20.939 1983 > <u>(1983/1984) ></u></p> <p>190 E 200 E 190 200</p>	<p>14-5010170 STD -mm 14-5010173 0,50 mm 14-5010178 1,00 mm</p>	<p>A = 43,200 B = 79,700 C = 2,000</p> <p>Steel Support</p>	<p>RE40200000 -STD RE40200050 -0,50 RE40200100 -1,00</p> <p>1,750 (500) Cr S IF 2,000 (508) P 3,500 (604) Cr P</p>	<p>ø22,0 x 56,0</p>			
<p>ø89,00</p> <p>4 Cyl. Gasoline 1997cc 63/74 KW 86/100PS M102V20.938 M102V20.939 <u>1982 - 1984</u></p> <p>190 200</p>	<p>14-5010350 STD -mm 14-5010353 0,50 mm 14-5010358 1,00 mm</p>	<p>A = 43,200 B = 83,200 C = 2,050 E = -0,550 F = -2,050</p> <p>Steel Support</p>	<p>RE40200000 -STD RE40200050 -0,50 RE40200100 -1,00</p> <p>1,750 (500) Cr S IF 2,000 (508) P 3,500 (604) Cr P</p>	<p>ø24,0 x 62,0</p>			

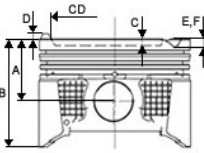
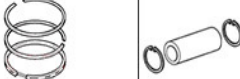







							
Engine	Ref. No. - Kit 1	Dimensions	Rings	Pin	Piston Liner	Kit 2	Info
<p>ø89,00</p> <p>4 6Cyl. Diesel 2299 cc 72 Kw (98 Ps) 22:1 OM 601D 23A.970</p> <p><u>1996 - 1999</u></p> <p>MERCEDES BENZ Viano 110D Vito 108D 110D 1996 - 1999</p>	<p>14-5089440 STD -mm 14-5089440-20 STD -mm (0.2 mm SHORT) 14-5089443 0,50 mm</p>	<p>A = 44,650 C = 9,060 E = -1,050 F = -1,250</p> <p>Ring Carrier Hard Anodising Oil Gallery</p>	<p>RE40220000 -STD RE40220050 -0,50 RE40220070 -0,70 RE40220100 -1,00</p> <p>2,500 (500) Cr IF 2,000 (508) P 3,000 (604) Cr P</p>	<p>ø28,0 x 70,0</p>			<p>1,74 mm Gasket + 0,83 + 1,06</p> <p>1,97 mm Gasket + 1,03 + 1,26</p>
<p>ø89,00</p> <p>4 Cyl. Diesel 2155 cc 70 Kw (95 Ps) OM 604 D22 910 912 915 917</p> <p><u>1993 -....</u></p> <p>MERCEDES BENZ C220 D E220 D (1993 -)</p>	<p>14-5092150 STD -mm 14-5092153 0,50 mm</p>	<p>A = 43,550 B = 73,550 C = 4,550 E = -2,350</p> <p>Ring Carrier Oil Gallery</p>	<p>RE40220000 -STD RE40220050 -0,50 RE40220070 -0,70 RE40220100 -1,00</p> <p>2,500 (500) Cr IF 2,000 (508) P 3,000 (604) Cr P</p>	<p>ø26,0 x 55,0</p>			<p>+ 0,73 + 0,97</p>

							
Engine	Ref. No. - Kit 1	Dimensions	Rings	Pin	Piston Liner	Kit 2	Info
<p>ø89,90</p> <p>6 Cyl. Gasoline 2799cc 150 KW 240 PS M112.915/917/912 914/916/913</p> <p><u>1995 -</u></p> <p>C240 CLK240 E280</p>	<p>14-5010320 STD -mm 14-5010323 0,50 mm</p>	<p>A = 33,700 B = 58,700 C = 0,600 E = -2,060 CD= 1,400</p> <p>Hard Anodising</p>	<p>RE40660000 -STD RE40660050 -0,50 RE40660100 -1,00</p> <p>1,500 (500) NiT S IF 1,750 (508) P 3,000 (700) NiT S</p>	<p>ø22,0 x 52,0</p>			
<p>ø90,90</p> <p>4 Cyl. Gasoline 2295cc 103 110 Kw 140 150PS M111.970</p> <p><u>1996 -</u></p> <p>MERCEDES BENZ C230 E230 ML230 1996 -</p>	<p>14-5010150 STD -mm 14-5010153 0,50 mm</p>	<p>A = 30,000 B = 55,000 D = 2,900 E = -1,000 CD= 88,000</p>	<p>RE40670000 -STD RE40670050 -0,50</p> <p>1,500 (500) NiT S IF 1,750 (508) P 3,000 (700) NiT S</p>	<p>ø22,0 x 56,0</p>			

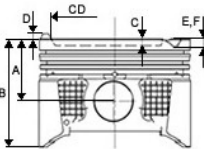







							
Engine	Ref. No. - Kit 1	Dimensions	Rings	Pin	Piston Liner	Kit 2	Info
<p>ø92,90</p> <p>V6/8 Gasoline, 3498/4663 cm³ 190/215250 kW (258/292/340 PS) 10:1/12,2:1,24Ventile 10,7:1,32Ventile M 272.960/961,964/967 970 972/975,977/980 988/991 Euro 4 M 273.922/924 <u>2005 -</u></p> <p>C 350 CLC 350 CLS 350 E 350 E 350 T GLK 350 ML 350 R 350 S 350 SL 350 SPRINTER 3 SPRINTER 224/424/524 VITO 126 3.5 VIANO 3.5 GL 450 S 450</p>	<p>14-5010330 STD -mm</p>	<p>A = 30,430 B = 50,830 E = -1,550</p>	<p>RE15260000 -STD ø20,0 RE15260000_NPR -STD ø48,0 RE15260050 -0,50 RE15260050_NPR -0,50</p> <p>1,200 (500) Cr S IF 1,500 (508) P 2,000 (700) Cr P S</p>				
<p>ø93,75</p> <p>4 Cyl. Gasoline 2307cc 66/78 KW 90/102PS 90:1 M115/970/971/972 973/974//952/955 <u>1973 - 1982</u></p> <p>O 309 230 230G</p>	<p>14-5010240 STD -mm 14-5010242 0,40 mm 14-5010247 0,80 mm</p>	<p>A = 51,800 B = 82,000</p> <p>Steel Support</p>	<p>RE40280000 -STD ø26,0 RE40280040 -0,40 x 73,0 RE40280080 -0,80</p> <p>1,750 (500) CR P IF 2,500 (508) P 4,000 (604) CR P</p>				

Engine	Ref. No. - Kit 1	Dimensions	Rings	Pin	Piston Liner	Kit 2	Info
<p>ø69,00</p> <p>4 Cyl. Gasoline 1149 cc 44 Kw (60 Ps) D7F F4P 44KW 700/701/702 706/710/720/ <u>1996 -....</u></p> <p><i>Clio 1.2i Kangoo 1.2i Twingo 1.2i</i></p>	<p>18-8010040 STD -mm 18-8010043 0,50 mm</p>	<p>A = 27,150 B = 50,500</p>	<p>RE49330000 -STD RE49330050 -0,50</p> <p>1,500 (500) Cr P IF 1,500 (501) P IFU 2,500 (604) Cr P</p>	<p>ø17,0 x 53,7</p>			
<p>ø75,80</p> <p>4 Cyl. Gasoline 1171 cc 44 Kw (60 Ps) 9,25:1 Catal.Conv E5FA710 E7F 08 <u>1991 - 1998</u></p> <p><i>Clio 1.2 RL RN RT</i></p>	<p>14-8010160 STD -mm</p>	<p>A = 35,100 B = 56,600 C = 1,200</p> <p>Steel Support</p>	<p>RE49410000 -STD RE49410050 -0,50</p> <p>1,500 (500) Cr P 1,750 (501) P IF 3,000 (604) P</p>	<p>ø19,0 x 60,0</p>			

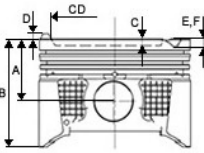

							
Engine	Ref. No. - Kit 1	Dimensions	Rings	Pin	Piston Liner	Kit 2	Info
<p>ø76,00</p> <p>4 Cyl. Diesel 1461 cc 74 Kw (100 Ps) K9K 728 Euro 3 <u>2004 -...</u></p> <p><i>Megane II 1,5 dCi</i> <i>Clio</i></p>	<p>18-8088330 STD -mm <i>18-8088330-20 STD -mm</i> <i>(0.2 mm SHORT)</i></p> <p>18-8088333 0,50 mm <i>18-8088333-20 0,50 mm</i> <i>(0.2 mm SHORT)</i></p> <p>18-8088338 1,00 mm</p>	<p>A = 41,700 B = 66,000 C = 14,000 E = -0,430 F = -0,250 CD= 39,700</p> <p>Ring Carrier Oil Gallery Oil Cut-Out</p>	<p>RE49400000 -STD RE49400050 -0,50 RE49400100 -1,00</p> <p>2,000 (500) CKP 2,000 (501) P 2,500 (604) CrP</p>	<p>ø26,0 x 60,0</p>			<p>+0.25 +0.30</p>
<p>ø76,00</p> <p>4 Cyl. Diesel 1461cc 78 Kw (106 Ps) Turbo, Intercooler K9K 732 Euro4 K9K 764 Euro4 K9K 780 Euro4 K9K 804 <u>2005 -....</u></p> <p><i>Megane II 1.5 dCi</i> <i>Scenic 1.5 dCi</i> <i>Clio Grandtour 1.5 dCi</i> <i>Clio III 1.5 dCi</i> <i>Modus 1.5 dCi</i> <i>Laguna III 1.5 dCi</i> <i>Kangoo 1.5 dCi</i> <i>Kangoo Be Bop 1,5 dCi</i> <i>Kangoo Express 1.5 dCi</i></p>	<p>18-8088440 STD -mm <i>18-8088440-20 STD -mm</i> <i>(0.2 mm SHORT)</i></p> <p>18-8088443 0,50 mm <i>18-8088443-20 0,50 mm</i> <i>(0.2 mm SHORT)</i></p> <p>18-8088448 1,00 mm</p>	<p>A = 41,700 B = 66,000 C = 12,800 E = -0,250 F = -0,430 CD= 49,000</p> <p>Ring Carrier Oil Gallery Oil Cut-Out</p>	<p>RE49400000 -STD RE49400050 -0,50 RE49400100 -1,00</p> <p>2,000 (500) CKP 2,000 (501) P 2,500 (604) CrP</p>	<p>ø26,0 x 60,0</p>			<p>+0.25 +0.30</p>









Engine	Ref. No. - Kit 1	Dimensions	Rings	Pin	Piston Liner	Kit 2	Info
<p>ø77,00</p> <p>4 Cyl. Diesel 1527cc 37 42 Kw (50 57 Ps) VJX VJY VJZ (TUD5) TUD 5 <u>1994 -....</u></p> <p>106 II Micro 1.5D Saxo 1.5D XSara 1.5D 106 1.5D 2 Serisi</p>	<p>18-7550420 STD -mm 18-7550422 0,40 mm</p>	<p>A = 40,400 B = 66,300 C = 1,580 E = -2,040</p> <p>Oil Cut-Out</p>	<p>RE47270000 -STD RE47270040 -0,40</p> <p>2,000 (500) Cr P 1,750 (501) P 3,000 (604) Cr P</p>	<p>ø23,0 x 60,0</p>			<p>+1,04 +1,14</p>
<p>ø77,00</p> <p>4 Cyl. Gasoline 1565 cc 69 Kw (94 Ps) 9:1 C2L <u>1985 - 1995</u></p> <p>R 11 Rainbow R 21 Optima 1985-1995</p>	<p>18-8010200 STD -mm</p>	<p>A = 34,000 B = 60,500 C = 1,950 CD= 65,000</p>	<p>RE49350000 -STD</p> <p>1,750 (500) Cr P 2,000 (508) P 4,000 (603) P</p>	<p>ø20,0 x 64,0</p>	<p>G80901340S_1</p> <p>A= 79,500 B= 75,000 D= 89,200 F= 0,000 H= 90,000 L= 135,000</p>		



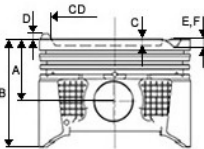





							
Engine	Ref. No. - Kit 1	Dimensions	Rings	Pin	Piston Liner	Kit 2	Info
<p>ø78,00</p> <p>H4J H4M</p> <p><i>Megane 3</i></p>	<p>18-8010210 STD -mm 18-8010213 0,50 mm</p>	<p>A = 34,300 B = 52,300 C = 7,680 E = -2,800 F = -6,500</p> <p>Hard Anodising</p>	<p>RJ23036A00 -STD - " ϕ20,0 RJ23036C00 -0,02 " x 52,2</p> <p>1,200 () CrI SV 1,200 () 2,000 () CrI</p>				
<p>ø80,00</p> <p>4 Cyl. Diesel 1598cc 96 KW 130PS R9M 402 <u>2015 -</u> <i>Qashgai (2015 -)</i></p>	<p>18-8092820 STD -mm 18-8092823 0,50 mm</p>	<p>A = 46,000 B = 70,500 C = 12,350 E = -0,300 CD= 46,500</p> <p>Ring Carrier Oil Gallery Oil Cut-Out</p>	<p>RE49510000 -STD ϕ30,0 RE49510050 -0,50 x 60,0</p> <p>2,000 (500) Cpk 1,750 (501) P IFU 2,000 (604) Cr P</p>				

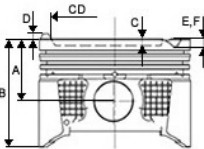

Engine	Ref. No. - Kit 1	Dimensions	Rings	Pin	Piston Liner	Kit 2	Info
<p>ø82,70</p> <p>4 Cyl. Gasoline 2000 cc F3R 722/723/728/729 <u>1994 -....</u></p> <p>Laguna 1 Megane Scenic 2.0</p>	<p>18-8010400 STD -mm 18-8010403 0,50 mm</p>	<p>A = 36,170 B = 60,000 C = 9,000 CD= 67,400</p> <p>Steel Support</p>	<p>RE49300000 -STD RE49300050 -0,50</p> <p>1,500 (500) CrB Fe S IF 1,750 (501) P 3,000 (700) Cr P S</p>	<p>ø21,0 x 57,0</p>			
<p>ø89,00</p> <p>4 Diesel, 2464 cm³ 74/107 kW (101/146 PS) 18:1 18,1:1,16 Ventile G9U 630 G9U 632 G9U 650 <u>10/2003 -....</u></p> <p>INTERSTAR DCI 100/120/150 PRIMASTAR DCI 150 MOVANO-A 2.5 CDTI VIVARO 2.5 CDTI/DTI TRAFIC II 2.5 DCI MASTER II 2.5 DCI</p>	<p>18-3092350 STD -mm 18-3092351 0,25 mm 18-3092353 0,50 mm</p>	<p>A = 53,075 B = 83,090 C = 16,300 E = -2,000 F = -1,700 CD= 48,000</p> <p>Ring Carrier Oil Gallery Oil Cut-Out</p>	<p>RE49490000 -STD RE49490050 -0,50</p> <p>3,000 (503) Cr P 1,750 (508) P 2,500 (604) Nit S</p>	<p>ø31,0 x 68,0</p>			

Engine	Ref. No. - Kit 1	Dimensions	Rings	Pin	Piston Liner	Kit 2	Info
<p>ø89,00</p> <p>4 Cyl. Diesel 2488 cc 110 Kw (150 Ps) 17,5:1 YD25DDTI TCI <u>2003 -....</u> D 22 Pick Up Skystar</p>	<p>18-8050010 STD -mm 18-8050013 0,50 mm</p>	<p>A = 48,850 B = 80,100 C = 18,100 E = -0,750 F = -1,200 CD= 43,000</p> <p>Ring Carrier Oil Gallery Oil Cut-Out</p>	<p>RJ23265A00 -STD - " ø28,0 RJ23265C00 -0,02 " x 61,0</p> <p>2,000 () GN SM 2,000 () 3,000 () DN</p>				
<p>ø89,00</p> <p>4 Cyl. Diesel 2500 cc 126/128 Kw (171/174 Ps) YD25DDTI <u>2005 -....</u> Navara 2.5 dci 16V Pathfinder 2.5 dci 16V</p>	<p>18-8092330 STD -mm 18-8092333 0,50 mm</p>	<p>A = 48,900 B = 73,900 C = 19,200 E = -1,150 F = -1,200 CD= 44,400</p> <p>Ring Carrier Oil Gallery Oil Cut-Out</p>	<p>RJ23265A00 -STD - " ø28,0 RJ23265C00 -0,02 " x 70,9</p> <p>2,000 () GN SM 2,000 () 3,000 () DN</p>				

							
Engine	Ref. No. - Kit 1	Dimensions	Rings	Pin	Piston Liner	Kit 2	Info
<p>ø89,00</p> <p>4 Cyl. Diesel 2488 cc 106 Kw 144 Ps YD25DDTI (D40) <u>2008 -....</u> Navara 2.5 dci</p>	<p>18-8092340 STD -mm 18-8092343 0,50 mm</p>	<p>A = 48,850 B = 73,800 C = 17,400 E = -1,200 F = -0,750 CD= 47,400</p> <p>Ring Carrier Oil Gallery</p>	<p>RJ23265A00 -STD - " ø28,0 RJ23265C00 -0,02 " x 70,9</p> <p>2,000 () GN SM 2,000 () 3,000 () DN</p>				
<p>ø92,90</p> <p>V6/8 Gasoline, 3498/4663 cm³ 190/215250 kW (258/292/340 PS) 10:1/12,2:1,24Ventile 10,7:1,32Ventile M 272.960/961,964/967 970 972/975,977/980 988/991 Euro 4 M 273.922/924 <u>2005 -</u> C 350 CLC 350 CLS 350 E 350 E 350/T GLK 350 ML 350 R 350 S350 SL 350 SPRINTER 3 SPRINTER 224/424/524 VITO 126 3.5 VIANO 3.5 GL 450 S 450</p>	<p>14-5010330 STD -mm</p>	<p>A = 30,430 B = 50,830 E = -1,550</p>	<p>RE15260000 -STD ø20,0 RE15260000_NPR -STD ø28,0 RE15260050 -0,50 RE15260050_NPR -0,50</p> <p>1,200 (500) Cr S IF 1,500 (508) P 2,000 (700) Cr P S</p>				

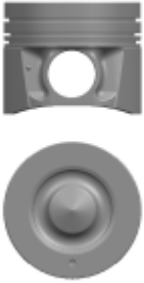
							
Engine	Ref. No. - Kit 1	Dimensions	Rings	Pin	Piston Liner	Kit 2	Info
<p>ø96,00</p> <p>4 Cyl. Diesel 3000 cc 89/125 Kw (121/170 Hp) ZD30DDTi <u>1987 -</u></p> <p><i>CABSTAR (F24) NT400 CAPSTAR (F24F) PATROL GRV (Y61) ELGRAND (E50) PATHFINDER II (R50) NAVARA (D22) CARAVAN BUS/KASTEN TERRANO (R20)</i></p>	<p>18-1592600 STD -mm 18-1592603 0,50 mm</p>	<p>A = 50,100 B = 78,100 C = 18,200 CD= 53,000</p> <p>Ring Carrier Oil Gallery Oil Cut-Out</p>	<p>RJ23177A00 -STD - " ø33,0 RJ23177C00 -0,02 " x 78,0</p> <p>2,500 () GN SM 2,000 () 2,000 () GN</p>				
							

Engine	Ref. No. - Kit 1	Dimensions	Rings	Pin	Piston Liner	Kit 2	Info
<p>ø69,60</p> <p>4 Cyl. Diesel 1248 cc 70 Ps 18:1 Turbo, Common Rail 16v 188.A8.000 Euro 4 188 A9.000 Euro 4 199 A2.000 Eur</p> <p><u>2003 -</u></p> <p>Agila 1.3 Corsa 1.3 Meriva 1.3 Tigra 1.3 Albea 1.3 Multijet Doblo 1.3 Multijet Palio 1.3 Multijet Idea 1.3 JTD Punto/EVO/Grand (188) (199) 1.3 JTD/D Fiorino 1.3 JTD</p>	<p>18-2050230 STD -mm 18-2050230-20 STD -mm (0.2 mm SHORT)</p> <p>18-2050230-40 STD -mm (0.4 mm SHORT)</p> <p>18-2050232 0,40 mm 18-2050232-20 0,40 mm (0.2 mm SHORT)</p> <p>18-2050232-40 0,40 mm (0.4 mm SHORT)</p> <p>18-2050237 0,80 mm 18-2050237-20 0,80 mm (0.2 mm SHORT)</p> <p>18-2050237-40 0,80 mm (0.4 mm SHORT)</p>	<p>A = 40,430 B = 63,430 C = 12,400 E = -1,000 F = -1,200 CD= 37,000</p> <p>Ring Carrier Oil Cut-Out</p>	<p>RE22030000 -STD RE22030040 -0,40 RE22030060 -0,60 RE22030080 -0,80</p> <p>2,000 (500) Cr P 1,500 (501) P 2,000 (604) Nit S</p>	<p>ø23,0 x 56,7</p>		<p>0,67 0,77 mm Gasket +0,02 +0,13</p> <p>0,77 0,87 mm Gasket +0,13 +0,23</p> <p>0,87 0,97 mm Gasket +0,23 +0,33</p>	
<p>ø69,60</p> <p>4 Cyl. Diesel 1248cc 75 HP/95 70Kw 16,8:1 1.3 75Hp Multi.jet II 16v Euro 5 95 PS A 13DTE</p> <p><u>2009 -</u></p> <p>1.3 CDTI Stop/Start Motorolara Ait (Astra J Corsa D Meriva) 1.3 CDTI (Astra J Corsa D Meriva) 1.3 D Multijet MITO STRADA Pick-up PANDA FIORINO Kasten/Kombi CUBO IDEA PUNTO Van AVEO Schrägheck(Euro-4)1</p>	<p>18-2092250 STD -mm 18-2092250-20 STD -mm (0.2 mm SHORT)</p> <p>18-2092250-40 STD -mm (0.4 mm SHORT)</p> <p>18-2092252 0,40 mm 18-2092252-20 0,40 mm (0.2 mm SHORT)</p> <p>18-2092252-40 0,40 mm (0.4 mm SHORT)</p> <p>18-2092257 0,80 mm 18-2092257-20 0,80 mm (0.2 mm SHORT)</p> <p>18-2092257-40 0,80 mm (0.4 mm SHORT)</p>	<p>A = 40,430 B = 62,430 C = 12,700 E = -1,153 F = -0,904 CD= 37,000</p> <p>Ring Carrier Oil Gallery Oil Cut-Out</p>	<p>RE22860000 -STD RE22860040 -0,40 RE22860060 -0,60 RE22860080 -0,80 RE22860100 -1,00</p> <p>1,500 (500) Cr P 1,500 (501) P 2,000 (604) Nit S</p>	<p>ø23,0 x 56,7</p>		<p>0,67 0,77 mm Gasket Yle</p> <p>+ 0,028 + 0,127 0,77 0,87 mm Gasket</p> <p>+0,127 +0,227 0,87 0,97 mm Gasket</p> <p>+ 0,228 + 0,327</p>	

Engine	Ref. No. - Kit 1	Dimensions	Rings	Pin	Piston Liner	Kit 2	Info
<p>ø69,60</p> <p>4 Cyl. Diesel 1248cc 75 HP 55/70 KW 75/95 PS B13 DTE/DTR 1.3 CDTi (EUR 6) <u>2006 -</u></p> <p>1.3 CDTi CORSA E Van (X15) CORSA E (X15) CORSAVAN Mk III (D) (S07) CORSAVAN Mk IV E (X15) CORSAVAN Mk IV E (X15)</p>	<p>18-2092260 STD -mm 18-2092260-20 STD -mm (0.2 mm SHORT)</p> <p>18-2092260-40 STD -mm (0.4 mm SHORT)</p> <p>18-2092262 0,40 mm 18-2092262-20 0,40 mm (0.2 mm SHORT)</p> <p>18-2092262-40 0,40 mm (0.4 mm SHORT)</p> <p>18-2092267 0,80 mm 18-2092267-20 0,80 mm (0.2 mm SHORT)</p> <p>18-2092267-40 0,80 mm (0.4 mm SHORT)</p>	<p>A = 40,430 B = 62,430 C = 12,000 CD= 42,300</p> <p>Ring Carrier Oil Gallery Oil Cut-Out</p>	<p>RE22860000 -STD RE22860040 -0,40 RE22860060 -0,60 RE22860080 -0,80 RE22860100 -1,00</p> <p>1,500 (500) Cr P 1,500 (501) P 2,000 (604) Nit S</p>	<p>ø23,0 x 56,7</p>			
<p>ø69,60</p> <p>4 Cyl. Diesel 1248cc 90 HP 1.3 90HP MULTIJET II 1.6V EURO 5 <u>2009 -</u></p> <p>Stop/Start Motorlara Ait DOBLO CARGO PRATICO</p>	<p>18-2092320 STD -mm 18-2092320-20 STD -mm (0.2 mm SHORT)</p> <p>18-2092320-40 STD -mm (0.4 mm SHORT)</p> <p>18-2092322 0,40 mm 18-2092322-20 0,40 mm (0.2 mm SHORT)</p> <p>18-2092322-40 0,40 mm (0.4 mm SHORT)</p> <p>18-2092327 0,80 mm 18-2092327-20 0,80 mm (0.2 mm SHORT)</p> <p>18-2092327-40 0,80 mm (0.4 mm SHORT)</p>	<p>A = 40,300 B = 62,430 C = 12,700 E = -1,153 F = -0,904 CD= 37,000</p> <p>Ring Carrier Oil Gallery Oil Cut-Out</p>	<p>RE22860000 -STD RE22860040 -0,40 RE22860060 -0,60 RE22860080 -0,80 RE22860100 -1,00</p> <p>1,500 (500) Cr P 1,500 (501) P 2,000 (604) Nit S</p>	<p>ø23,0 x 56,7</p>			<p>0,67 0,77 mm Gasket Yle</p> <p>+ 0,028 + 0,127 0,77 0,87 mm Gasket</p> <p>+0,127 +0,227 0,87 0,97 mm Gasket</p> <p>+ 0,228 + 0,327</p>

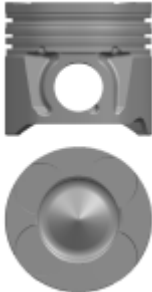
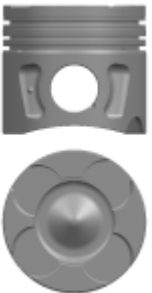
Engine	Ref. No. - Kit 1	Dimensions	Rings	Pin	Piston Liner	Kit 2	Info
<p>ø69,60</p> <p>4 Cyl. Diesel 1248 cc 70 Ps 18:1 Turbo, Common Rail 16v 188.A8.000 Euro 4 188 A9.000 Euro 4 199 A2.000 Eur</p> <p><u>2003 -....</u></p> <p>Agila 1.3 Corsa 1.3 Meriva 1.3 Tigra 1.3 Albea 1.3 Multijet Doblo 1.3 Multijet Palio 1.3 Multijet Suzuki 1.3 Multijet</p>	<p>18-3050230 STD -mm <i>18-3050230-20 STD -mm (0.2 mm SHORT)</i> 18-3050230-40 STD -mm (0.4 mm SHORT)</p> <p>18-3050232 0,40 mm <i>18-3050232-20 0,40 mm (0.2 mm SHORT)</i> <i>18-3050232-40 0,40 mm (0.4 mm SHORT)</i></p> <p>18-3050234 0,60 mm <i>18-3050234-20 0,60 mm (0.2 mm SHORT)</i> <i>18-3050234-40 0,60 mm (0.4 mm SHORT)</i></p> <p>18-3050237 0,80 mm <i>18-3050237-20 0,80 mm (0.2 mm SHORT)</i> <i>18-3050237-40 0,80 mm (0.4 mm SHORT)</i></p> 	<p>A = 40,430 B = 63,430 C = 12,400 E = -1,000 F = -1,200 CD= 38,000</p> <p>Ring Carrier Oil Cut-Out</p>	<p>RE22030000 -STD RE22030040 -0,40 RE22030060 -0,60 RE22030080 -0,80</p> <p>2,000 (500) Cr P 1,500 (501) P 2,000 (604) Nit S</p>	<p>ø23,0 x 56,7</p>		<p>0,67 0,77 mm Gasket +0,02 +0,13</p> <p>0,77 0,87 mm Gasket +0,13 +0,23</p> <p>0,87 0,97 mm Gasket +0,23 +0,33</p>	
<p>ø69,60</p> <p>4 Cyl. Diesel 1248 cc 66 Kw (90 Ps) 17,6:1 199A3000 Multijet Euro 5 Z13 DTH A13DTE Euro 5 16V</p> <p><u>2009 -....</u></p> <p>ASTRA J CORSA D Grande Punto1.3CDTI 16V Linea Grande Punto</p>	<p>18-3082550 STD -mm <i>18-3082550-20 STD -mm (0.2 mm SHORT)</i> 18-3082550-40 STD -mm (0.4 mm SHORT)</p> <p>18-3082552 0,40 mm <i>18-3082552-20 0,40 mm (0.2 mm SHORT)</i> <i>18-3082552-40 0,40 mm (0.4 mm SHORT)</i></p> <p>18-3082557 0,80 mm <i>18-3082557-20 0,80 mm (0.2 mm SHORT)</i> <i>18-3082557-40 0,80 mm (0.4 mm SHORT)</i></p> 	<p>A = 40,430 B = 62,430 C = 12,400 E = -0,904 F = -1,154 CD= 38,000</p> <p>Ring Carrier Oil Gallery Oil Cut-Out</p>	<p>RE22030000 -STD RE22030040 -0,40 RE22030060 -0,60 RE22030080 -0,80</p> <p>2,000 (500) Cr P 1,500 (501) P 2,000 (604) Nit S</p>	<p>ø23,0 x 56,7</p>		<p>0,67 0,77 mm Gasket Yle +0,028 +0,127</p> <p>0,77 0,87 mm Gasket +0,127 +0,227</p> <p>0,87 0,97 mm Gasket +0,228 +0,327</p>	

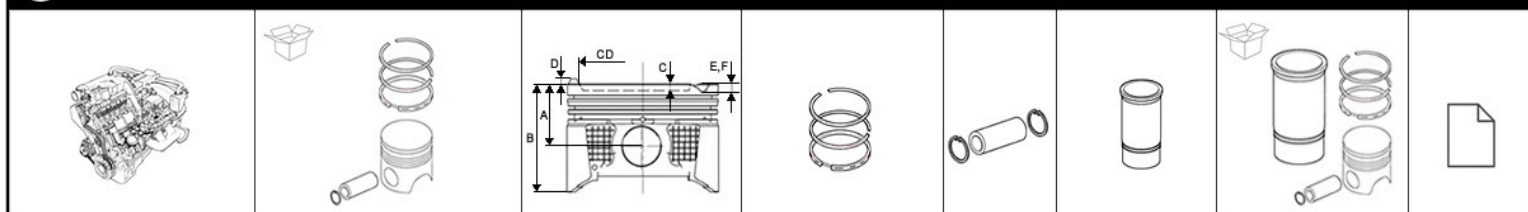

Engine	Ref. No. - Kit 1	Dimensions	Rings	Pin	Piston Liner	Kit 2	Info
--------	------------------	------------	-------	-----	--------------	-------	------



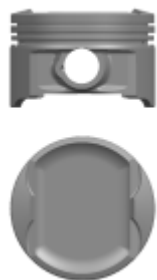





<p>ø69,70</p> <p>4 Cyl. Gasoline 1229cc 63kw 86 PS 1T2G1 <u>2010 -</u></p> <p><i>Aveo II 1.2i 16V Corsa D 1.2i 16V</i></p>	<p>18-1010150 STD -mm 18-1010153 0,50 mm</p>	<p>A = 27,720 B = 47,720 C = 4,300 E = -1,100 F = -1,570 CD= 63,300</p> <p>Oil Cut-Out</p>	<p>RE16010000 -STD RE16010050 -0,50</p> <p>1,200 (300) 1,200 (300) 2,000 (300)</p>	<p>ø17,0 x 53,5</p>			
--	--	--	--	-------------------------	--	--	--

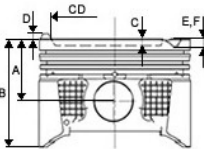

<p>ø72,00</p> <p>R 4 Petrol, 1200 cm³ 33 kW (45 hp), 10:1 X12SZ <u>1992 -</u></p> <p><i>Corsa Nova</i></p>	<p>18-3010170 STD -mm 18-3010173 0,50 mm</p>	<p>A = 32,050 B = 59,000 C = 2,800 CD= 60,000</p>	<p>RE43000000 -STD RE43000050 -0,50</p> <p>1,500 (500) CrP 1,500 (508) P 3,000 (700) CrP</p>	<p>ø18,0 x 50,9</p>			
---	--	---	--	-------------------------	--	--	--











Engine	Ref. No. - Kit 1	Dimensions	Rings	Pin	Piston Liner	Kit 2	Info
<p>ø72,00</p> <p>R 4 Petrol, 1200 cm³ 33 kW (45 hp), 9:1 C12NZ 12NZ <u>1990-1992</u> <i>(8 Ventil) Corsa-B 1.2 Transporter Combo 1.2</i></p>	<p>18-3010180 STD -mm 18-3010183 0,50 mm</p>	<p>A = 32,050 B = 58,050 C = 4,100 CD= 63,550</p>	<p>RE43000000 -STD RE43000050 -0,50</p> <p>1,500 (500) CrP 1,500 (508) P 3,000 (700) CrP</p>	<p>ø18,0 x 55,0</p>			
<p>ø72,50</p> <p>4 Cyl. Gasoline 1364 cc 103/110KW 140/150 PS A14NET TURBO ECOTEC (2011 ...) B14NEH TURBO (2015 ...) <u>2011/2015 -</u> <i>Astra J Corsa E</i></p>	<p>18-3010110 STD -mm 18-3010110-30 STD -mm 18-3010113 0,50 mm 18-3010113-30 0,50 mm</p>	<p>A = 25,870 B = 44,180 C = 2,900 E = -2,000</p> <p>Ring Carrier Hard Anodising</p>	<p>RE43500000 -STD RE43500050 -0,50</p> <p>1,200 (504) NitB S IF 1,200 (508) P 2,000 (700) Nit S</p>	<p>ø18,0 x 48,0</p>			

							
Engine	Ref. No. - Kit 1	Dimensions	Rings	Pin	Piston Liner	Kit 2	Info
<p>ø72,50</p> <p>R 3 Gasoline, 973 cm³ 40 43 kW (54 58 PS) 10,1:1, 12 Ventile X10XE Z10XE <u>1996-2003</u></p> <p><i>Corsa Nova</i></p>	<p>14-3010190 STD -mm 14-3010193 0,50 mm</p>	<p>A = 24,000 B = 45,000 C = 1,200 E = -1,250 CD= 54,000</p>	<p>RE43360000 -STD RE43360050 -0,50</p> <p>1,200 (500) NitBSIF 1,500 (508) P 2,000 (700) Nits</p>	<p>ø18,0 x 51,0</p>			
<p>ø72,50</p> <p>4Cyl. Gasoline 1199 cc 44 48 Kw (60 65 Ps) X12XE Z12XE <u>1997-2003</u></p> <p><i>Astra Corso Agile</i></p>	<p>18-3010200 STD -mm 18-3010203 0,50 mm</p>	<p>A = 24,000 B = 45,000 C = 1,250</p>	<p>RE43360000 -STD RE43360050 -0,50</p> <p>1,200 (500) NitBSIF 1,500 (508) P 2,000 (700) Nits</p>	<p>ø18,0 x 50,9</p>			

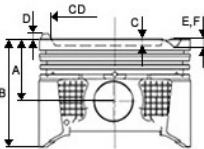









Engine	Ref. No. - Kit 1	Dimensions	Rings	Pin	Piston Liner	Kit 2	Info
<p>ø73,40</p> <p>4 Cyl. Gasoline 1229cc 63 kw/ 86 PS A12XER Euro 5 <u>2010 -</u></p> <p>Aveo II 1.2i 16V Corsa D 1.2i 16V</p>	<p>18-1010140 STD -mm 18-1010143 0,50 mm</p>	<p>A = 26,900 B = 47,900 D = 0,650 E = -1,350 F = -3,950 CD= 54,600</p> <p>Hard Anodising</p>	<p>RE43390000 -STD RE43390050 -0,50</p> <p>1,200 (500) NitBS 1,200 (508) P 2,000 (700) CrPS</p>	<p>ø18,0 x 53,0</p>			
<p>ø73,40</p> <p>4 Cyl. Gasoline 1364 cc 74 Kw 101 PS A14XER <u>2009 - 2011</u></p> <p>Astra J 1.4i16V Aveo II 1.4i16V Corsa D 1.4i 16V Meriva B 1.4i16V</p>	<p>18-3010130 STD -mm 18-3010133 0,50 mm</p>	<p>A = 25,800 B = 46,800 C = 1,600 E = -1,900 F = -3,830</p> <p>Hard Anodising</p>	<p>RE43390000 -STD RE43390050 -0,50</p> <p>1,200 (500) NitBS 1,200 (508) P 2,000 (700) CrPS</p>	<p>ø18,0 x 53,0</p>			



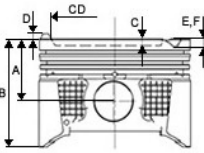







							
Engine	Ref. No. - Kit 1	Dimensions	Rings	Pin	Piston Liner	Kit 2	Info
<p>ø73,40</p> <p>R 3 Gasoline, 998 cm³ 44 kW (60 PS) 10,5:1,12 Ventile Z10XEP <u>2003-2007</u></p> <p><i>Corsa Agile</i></p>	<p>18-3010140 STD -mm 18-3010143 0,50 mm</p>	<p>A = 24,000 B = 45,000 C = 0,820 E = -1,330 F = -1,350 CD= 52,000</p>	<p>RE43390000 -STD RE43390050 -0,50</p> <p>1,200 (500) NitBS 1,200 (508) P 2,000 (700) CrPS</p>	<p>ø18,0 x 50,9</p>			
<p>ø73,40</p> <p>4 Cyl. Gasoline 1229 cc 59 KW (80 PS) Z12XEP <u>2004-.....</u></p> <p><i>Corsa C Agila Astra H Astra MK</i></p>	<p>18-3010150 STD -mm 18-3010153 0,50 mm</p>	<p>A = 24,000 B = 45,000 D = 0,530 E = -1,460 F = -1,490</p>	<p>RE43390000 -STD RE43390050 -0,50</p> <p>1,200 (500) NitBS 1,200 (508) P 2,000 (700) CrPS</p>	<p>ø18,0 x 50,9</p>			

Engine	Ref. No. - Kit 1	Dimensions	Rings	Pin	Piston Liner	Kit 2	Info
<p>ø73,40</p> <p>4 Cyl. Gasoline 1364 cc 66 Kw (90 Ps) 10,5:1 Catal.Conv Z14XEP <u>2001 -....</u></p> <p>Astra 1.4 Corsa 1.4 Meriva 1.4</p>	<p>18-3010160 STD -mm 18-3010163 0,50 mm</p>	<p>A = 23,000 B = 44,000 C = 1,250 E = -1,330 F = -1,350 CD= 53,500</p>	<p>RE43390000 -STD RE43390050 -0,50</p> <p>1,200 (500) NitBS 1,200 (508) P 2,000 (700) CrPS</p>	<p>ø18,0 x 50,9</p>			
<p>ø74,00</p> <p>3 Cyl. Gasoline 999 cc 66/77 KW 90/105 PS B10XFL Ecotec <u>2014 -.</u></p> <p>Astra Corsa Ascona Manta Kadett</p>	<p>18-3010060 STD -mm 18-3010063 0,50 mm</p>	<p>A = 27,500 B = 46,000 D = 2,500 E = -1,680 F = -2,810</p> <p>Hard Anodising</p>	<p>RE43640000 -STD -" RE43640050 -0,02 " "</p> <p>1,200 () 1,200 () 2,000 ()</p>	<p>ø19,0 x 47,2</p>			

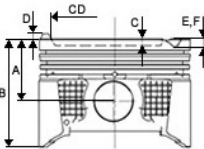









							
Engine	Ref. No. - Kit 1	Dimensions	Rings	Pin	Piston Liner	Kit 2	Info
<p>ø74,00</p> <p>4 Cyl. Gasoline 1399 cc 110 KW 150 HP B14XFT <u>2014 -.</u> Astra K</p>	<p>18-3010070 STD -mm 18-3010073 0,50 mm</p>	<p>A = 27,500 B = 46,000 D = 2,500 E = -1,680 F = -2,810</p> <p>Hard Anodising</p>	<p>RE43640000 -STD -" RE43640050 -0,02 "</p> <p>1,200 () 1,200 () 2,000 ()</p>	<p>ø19,0 x 47,2</p>			
<p>ø75,00</p> <p>Cyl. Gasoline 1297 cc 44 Kw (60 Ps) 9: Injection, Catal.Conv 1.3N 1.3NB 1.3S 1.3SB C1.3N <u>1986 - 1990</u> Astra Corsa Ascona Manta Kadett</p>	<p>14-3010050 STD -mm 14-3010053 0,50 mm</p>	<p>A = 35,800 B = 62,400 C = 3,600 E = -5,400 CD= 63,500</p> <p>Steel Support</p>	<p>RE43030000 -STD RE43030050 -0,50 RE43030100 -1,00</p> <p>1,500 (500) CrP 1,500 (501) P 4,000 (700) CrP</p>	<p>ø20,0 x 65,0</p>			

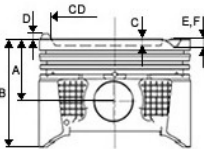









							
Engine	Ref. No. - Kit 1	Dimensions	Rings	Pin	Piston Liner	Kit 2	Info
<p>ø75,00</p> <p>4 Cyl. Gasoline 1297 cc 50 55 Kw (68 75 Ps) 1.3 S C1.3N <u>1986-1990</u></p> <p>Astra Corsa Ascona Manta Kadett</p>	<p>14-3010550 STD -mm 14-3010553 0,50 mm</p>	<p>A = 35,800 B = 62,400 C = 3,600 E = -4,750 CD= 63,000</p>	<p>RE43030000 -STD RE43030050 -0,50 RE43030100 -1,00</p> <p>1,500 (500) CrP 1,500 (501) P 4,000 (700) CrP</p>	<p>ø20,0 x 65,0</p>			
<p>ø76,00</p> <p>R4 1488 cc 37 kw 50 hp 4EC1 <u>1985-2000</u></p> <p>Corsa Kadett</p>	<p>14-3050210 STD -mm</p>	<p>A = 41,700 B = 71,700 C = 1,600 E = -0,350</p> <p>Ring Carrier</p>	<p>RE43040000 -STD RE43040050 -0,50</p> <p>2,000 (500) CrP 1,500 (501) P 3,000 (604) CrP</p>	<p>ø22,0 x 60,0</p>			

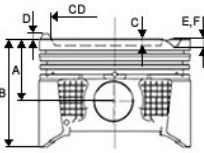









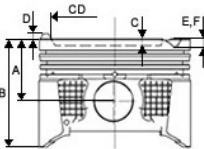

							
Engine	Ref. No. - Kit 1	Dimensions	Rings	Pin	Piston Liner	Kit 2	Info
<p>ø76,00</p> <p>R 4 Diesel, 1488 cm³ 49 kW (67 hp), 22,5:1 15TD <u>1988 -....</u> <i>Corsa Kadett</i></p>	<p>14-3050220 STD -mm</p>	<p>A = 41,700 B = 71,700 C = 1,600 E = -0,350</p> <p>Ring Carrier</p>	<p>RE43040000 -STD RE43040050 -0,50</p> <p>2,000 (500) CrP 1,500 (501) P 3,000 (604) CrP</p>	<p>ø25,0 x 60,0</p>			
<p>ø77,60</p> <p>4 Cyl. Gasoline 1389 cc 66 Kw (90 Ps) Z1.4XE GLHB <u>1999 -....</u> <i>Astra 1.4 Corsa 1.4 E16 SE16V C16 SE ENJ/KAT</i></p>	<p>18-3010300 STD -mm 18-3010303 0,50 mm</p>	<p>A = 31,300 B = 55,750 D = 2,450</p>	<p>RE43480000 -STD RE43480050 -0,50 RE43480100 -1,00</p> <p>1,200 (500) NitB S 1,500 (501) P 2,000 (700) Cr P S</p>	<p>ø18,0 x 55,0</p>			



							
Engine	Ref. No. - Kit 1	Dimensions	Rings	Pin	Piston Liner	Kit 2	Info
<p>ø77,60</p> <p>4 Cyl. Gasoline 1396 cc 44 Kw (60 Ps) 9,4:1 C14NZ Z14NZ 14NV <u>1991-....</u></p> <p>Astra Corsa Ascona Kadett</p>	<p>18-3010650 STD -mm 18-3010653 0,50 mm</p>	<p>A = 32,050 B = 52,500 C = 3,300</p>	<p>RE43050000 -STD RE43050050 -0,50</p> <p>1,500 (500) CrP 1,500 (501) P 3,000 (700) CrP</p>	<p>ø18,0 x 55,0</p>			
<p>ø77,60</p> <p>4 Cyl. Gasoline 1389 cc 66 Kw (90 Ps) 10,5:116 v Injection, Catal.Conv X14XE <u>1994-2000</u></p> <p>Astra 1,4i 16v Corsa CDX 1,4i 16v Tigra 1,4i 16v</p>	<p>18-3010770 STD -mm 18-3010773 0,50 mm</p>	<p>A = 32,050 B = 57,050 D = 0,300 E = -0,650</p> <p>Steel Support</p>	<p>RE43050000 -STD RE43050050 -0,50</p> <p>1,500 (500) CrP 1,500 (501) P 3,000 (700) CrP</p>	<p>ø18,0 x 55,0</p>			



							
Engine	Ref. No. - Kit 1	Dimensions	Rings	Pin	Piston Liner	Kit 2	Info
<p>ø79,00</p> <p>4Cyl. Gasoline 1598 cc 74 78 Kw (101 106 Ps) 10,5:1 16v Injection Catal.Conv X16XE X16XEL <u>1991-1995</u></p> <p>Astra Corsa Tigra Zafira Vectra</p> 	<p>18-3010380 STD -mm 18-3010383 0,50 mm</p>	<p>A = 28,000 B = 48,000 C = 0,800 E = -1,900 F = -2,150 CD= 60,200</p> <p>Steel Support</p>	<p>RE43320000 -STD RE43320050 -0,50</p> <p>1,200 (500) CrB S 1,500 (508) P 2,500 (700) Cr P S</p>	<p>ø18,0 x 55,0</p>			
<p>ø79,00</p> <p>4Cyl. Gasoline 1598 cc 74 Kw (101 Ps) Y16 XE Z16XE <u>2000-.....</u></p> <p>Vectra 1.6i 16v Astra 1.6i Meriva 1.6i 16v Zafira 1.6i 16v</p> 	<p>18-3010390 STD -mm 18-3010393 0,50 mm</p>	<p>A = 27,200 B = 50,200</p>	<p>RE43320000 -STD RE43320050 -0,50</p> <p>1,200 (500) CrB S 1,500 (508) P 2,500 (700) Cr P S</p>	<p>ø18,0 x 55,0</p>			

Engine	Ref. No. - Kit 1	Dimensions	Rings	Pin	Piston Liner	Kit 2	Info
<p>ø79,00</p> <p>4 Cyl. Gasoline 1598 cc 74 Kw (101 Ps) Z16XEP <u>2003 -....</u></p> <p><i>Meriva 1.6</i> <i>Astra Twinport</i></p>	<p>18-3010400 STD -mm 18-3010403 0,50 mm 18-3010408 1,00 mm</p>	<p>A = 26,730 B = 48,730</p>	<p>RE43490000 -STD RE43490050 -0,50 RE43490100 -1,00</p> <p>1,200 (500) NitB S 1,200 (501) P 2,000 (700) Cr P S</p>	<p>ø18,0 x 52,0</p>			
<p>ø79,00</p> <p>4 Cyl. Gasoline 1600 cc 132KW (180 BG) A16/Z16 LEL/LER/LET Euro 5 <u>2008/2009 -....</u></p> <p><i>Corsa D 1.6i Turbo 16V</i> <i>Astra H-J 1.6i 16V</i> <i>Insigna 1.6i Turbo 16V</i></p>	<p>18-3010420 STD -mm 18-3010423 0,50 mm 18-3010428 1,00 mm</p>	<p>A = 27,500 B = 45,100</p> <p>Hard Anodising</p>	<p>RE43490000 -STD RE43490050 -0,50 RE43490100 -1,00</p> <p>1,200 (500) NitB S 1,200 (501) P 2,000 (700) Cr P S</p>	<p>ø19,0 x 53,0</p>			



Engine	Ref. No. - Kit 1	Dimensions	Rings	Pin	Piston Liner	Kit 2	Info
<p>ø79,00</p> <p>R 4 Gasoline, 1598 cm³ 55 75 kW (75 102 PS) 8,6:1 Enjekt C16NZ X16SZR E16NZ X16SZ GLBH 1.6 LZ <u>1987-1993</u></p> <p>Astra II 1.6 I Kat Corsa Kadett Vectra Ascona</p>	<p>18-3010480 STD -mm 18-3010483 0,50 mm</p>	<p>A = 28,000 B = 48,400 C = -2,700 D = 0,400 CD= 62,500</p>	<p>RE43090000 -STD RE43090025 -0,25 RE43090050 -0,50 RE43090100 -1,00</p> <p>1,200 (500) CrB S 1,500 (508) P 3,000 (700) Cr S P</p>	<p>ø18,0 x 55,0</p>			
<p>ø79,00</p> <p>R 4 Gasoline, 1598 cm³ 60 66 kW (82 90 PS) C16SE E16SE 16SV</p> <p>Astra Corsa Kadett Vectra</p>	<p>18-3010580 STD -mm 18-3010583 0,50 mm 18-3010588 1,00 mm</p>	<p>A = 28,000 B = 48,400 C = 1,600 D = 0,400 CD= 59,000</p>	<p>RE43090000 -STD RE43090025 -0,25 RE43090050 -0,50 RE43090100 -1,00</p> <p>1,200 (500) CrB S 1,500 (508) P 3,000 (700) Cr S P</p>	<p>ø18,0 x 55,0</p>			



Engine	Ref. No. - Kit 1	Dimensions	Rings	Pin	Piston Liner	Kit 2	Info
<p>ø79,00</p> <p>4 Cyl. Diesel 1686 cc 55 Kw (75 Ps) 18,4:1 Turbo, Intercooler Y17DT/DTL</p> <p><u>2002-2005</u></p> <p>Astra G Combo Box Corsa C Meriva</p>	<p>18-3050260 STD -mm <i>18-3050260-20 STD -mm</i> <i>(0.2 mm SHORT)</i></p> <p>18-3050263 0,50 mm <i>18-3050263-20 0,50 mm</i> <i>(0.2 mm SHORT)</i></p> <p>18-3050268 1,00 mm <i>18-3050268-20 1,00 mm</i> <i>(0.2 mm SHORT)</i></p>	<p>A = 39,740 B = 84,000 C = 14,000 E = -1,100 CD= 38,700</p> <p>Ring Carrier Oil Cut-Out</p>	<p>RE43100000 -STD RE43100025 -0,25 RE43100050 -0,50 RE43100100 -1,00</p> <p>2,000 (500) Cr 1,500 (501) P 3,000 (604) Cr P</p>	<p>ø27,0 x 64,0</p>			<p>1,45 mm Gasket +0,63 +0,70</p> <p>1,50 mm Gasket +0,70 +0,76</p> <p>1,55 mm Gasket 0,76 0,83</p>
<p>ø79,00</p> <p>R 4 Diesel, 1689 cm³ 59 kW (80 PS) 18,4:1,16 Ventile Z17DTL</p> <p><u>2003-2009</u></p> <p>Astra G Combo Box Corsa C Meriva</p>	<p>18-3050270 STD -mm <i>18-3050270-20 STD -mm</i> <i>(0.2 mm SHORT)</i></p> <p>18-3050273 0,50 mm <i>18-3050273-20 0,50 mm</i> <i>(0.2 mm SHORT)</i></p>	<p>A = 39,740 B = 84,000 C = 14,000 CD= 41,800</p> <p>Ring Carrier</p>	<p>RE43100000 -STD RE43100025 -0,25 RE43100050 -0,50 RE43100100 -1,00</p> <p>2,000 (500) Cr 1,500 (501) P 3,000 (604) Cr P</p>	<p>ø27,0 x 64,0</p>			

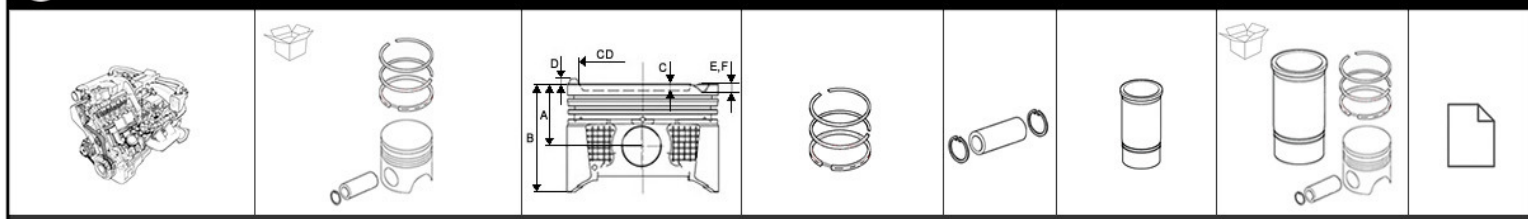

Engine Ref. No. - Kit 1 Dimensions Rings Pin Piston Liner Kit 2 Info

<p>ø79,00</p> <p>R 4 Diesel, 1689 cm³ 74 kW (100 PS) 18,4:1,16 Ventile Z17DTH</p> <p>Astra-H 1. CDTI 03/2004-02/2007 Combo 1.7 CDTI 12/2004- Corsa-C 1.7 CDTI 06/2003-08/2003 Meriva 1.7 CDTI 09/2003-05/2010</p>	<p>18-3050280 STD -mm <i>18-3050280-20 STD -mm</i> <i>(0.2 mm SHORT)</i></p> <p>18-3050281 0,25 mm 18-3050283 0,50 mm <i>18-3050283-20 0,50 mm</i> <i>(0.2 mm SHORT)</i></p> <p>18-3050288 1,00 mm</p>	<p>A = 39,750 B = 64,750 C = 14,100 E = -1,300 F = -1,200 CD= 41,800</p> <p>Ring Carrier Oil Gallery</p>	<p>RE43100000 -STD RE43100025 -0,25 RE43100050 -0,50 RE43100100 -1,00</p> <p>2,000 (500) Cr 1,500 (501) P 3,000 (604) Cr P</p>	<p>ø27,0 x 64,0</p>			
---	--	--	--	-------------------------	--	--	--

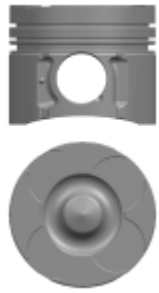



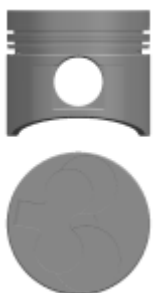





<p>ø79,00</p> <p>R 4 Diesel, 1686 cm³ 44 65 kW (60 88 PS) 22:1, 8 Ventile 17D(4EE1) TC4EE 1 X 17D(4EE1) <u>1991-2006</u></p> <p>Corsa B 1,7 D Combo 1,7 D ASTRA-F 1.7 TDS</p>	<p>14-3050940 STD -mm 14-3050943 0,50 mm</p>	<p>A = 39,700 B = 69,600 C = 1,900 E = -1,200</p> <p>Ring Carrier</p>	<p>RE43100000 -STD RE43100025 -0,25 RE43100050 -0,50 RE43100100 -1,00</p> <p>2,000 (500) Cr 1,500 (501) P 3,000 (604) Cr P</p>	<p>ø27,0 x 64,0</p>			
---	--	---	--	-------------------------	--	--	--

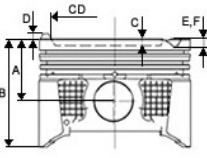

Engine	Ref. No. - Kit 1	Dimensions	Rings	Pin	Piston Liner	Kit 2	Info
<p>ø79,00</p> <p>4Cyl. Diesel 1686 cc 44/60 Kw (60/82 Ps) Turbo XATD 1.7TD</p> <p><u>1998 -....</u></p> <p>Corsa 1,7 D Combo 1,7</p>	<p>18-3050950 STD -mm <i>18-3050950-20 STD -mm (0.2 mm SHORT)</i></p> <p>18-3050953 0,50 mm <i>18-3050953-20 0,50 mm (0.2 mm SHORT)</i></p> <p>18-3050958 1,00 mm <i>18-3050958-20 1,00 mm (0.2 mm SHORT)</i></p>	<p>A = 39,700 B = 79,800 C = 1,200 E = -0,400</p> <p>Ring Carrier Steel Support</p>	<p>RE43100000 -STD RE43100025 -0,25 RE43100050 -0,50 RE43100100 -1,00</p> <p>2,000 (500) Cr 1,500 (501) P 3,000 (604) Cr P</p>	<p>ø25,0 x 60,0</p>			
<p>ø79,01</p> <p>4 Cyl. Gasoline 1600cc 120 BG Z16XER A16XER 1.6 CRUZE OEM2510255</p> <p><u>2009 -....</u></p> <p>Astra H Astra J Insignia 1.6 Cruze 1.6</p>	<p>18-3010410 STD -mm 18-3010413 0,50 mm 18-3010418 1,00 mm</p>	<p>A = 26,700 B = 48,700 D = 1,200 E = -1,900 F = -2,700 CD= 52,960</p> <p>Hard Anodising</p>	<p>RE43490000 -STD RE43490050 -0,50 RE43490100 -1,00</p> <p>1,200 (500) NitB S 1,200 (501) P 2,000 (700) Cr P S</p>	<p>ø19,0 x 46,0</p>			



							
Engine	Ref. No. - Kit 1	Dimensions	Rings	Pin	Piston Liner	Kit 2	Info
<p>ø79,70</p> <p>4 Cyl. Diesel 1598 cc 100 Kw (136 Ps) B16DTH Euro 6 Ecotec <u>2013 -.</u> Astra Vectra</p>	<p>18-3092310 STD -mm 18-3092313 0,50 mm</p>	<p>A = 45,800 B = 70,800 C = 13,500 E = -1,100 F = -1,000 CD= 45,000</p> <p>Ring Carrier Oil Gallery Oil Cut-Out</p>	<p>RE43610000 -STD RE43610050 -0,50</p> <p>1,500 (xxx) Cr 1,500 (xxx) P 2,000 (xxx)</p>				
<p>ø79,70</p> <p>4 Cyl. Diesel 1598 cc 110 Ps B16DTL Euro 6 Ecotec <u>2013 -.</u> Astra Zafir</p>	<p>18-3092320 STD -mm 18-3092323 0,50 mm</p>	<p>A = 40,800 B = 65,800 C = 13,500 E = -1,100 F = -1,000 CD= 45,000</p> <p>Ring Carrier Oil Gallery Oil Cut-Out</p>	<p>RE43610000 -STD RE43610050 -0,50</p> <p>1,500 (xxx) Cr 1,500 (xxx) P 2,000 (xxx)</p>				

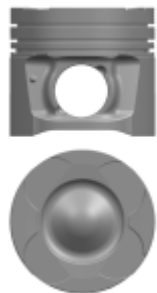









Engine	Ref. No. - Kit 1	Dimensions	Rings	Pin	Piston Liner	Kit 2	Info
<p>ø80,00</p> <p>4. Cyl. Gasolinecc</p> <p>1.6 LZ 1.6 LZ 2 <u>1994 - 2001</u></p> <p>1.6 LZ VECTRA A (94..95) 1.6 LZ 2 VECTRA B (96..2001)</p>	<p>18-3010670 STD -mm 18-3010673 0,50 mm</p>	<p>A = 33,650 B = 57,650 C = 2,900 CD= 58,000</p>	<p>RE43570000 -STD RE43570050 -0,50</p> <p>1,500 () Cr 1,500 () 2,000 () Cr</p>	<p>ø21,0 x 53,0</p>			
<p>ø80,00</p> <p>4 Cyl. Diesel 1598 cc 40 Kw (54 Ps) 22,5:1 16 D 16 DA <u>1982-1989</u></p> <p>Astra G Combo Box Corsa C Meriva</p>	<p>18-3050900 STD -mm 18-3050903 0,50 mm 18-3050908 1,00 mm</p>	<p>A = 44,950 B = 76,950 C = 1,500</p> <p>Ring Carrier Hard Anodising Steel Support</p>	<p>RE43110000 -STD RE43110050 -0,50 RE43110100 -1,00</p> <p>2,000 (500) CrB S 2,000 (501) P 3,000 (604) Cr P</p>	<p>ø26,0 x 65,0</p>			<p>1,30 mm Gasket 0 +0,75</p> <p>1,40 mm Gasket +0,75 +0,85</p> <p>1,50 mm Gasket +0,85 +1,05</p>

Engine	Ref. No. - Kit 1	Dimensions	Rings	Pin	Piston Liner	Kit 2	Info
<p>ø80,00</p> <p>4/6 Cyl. Diesel 1669/2498 cc 105 Kw (90/143 Ps) M41 M51 D25WA BMW <u>1990 -....</u></p> <p><i>Turbo Intercooler 318 Compact TDS/TouringSE 325 325/525 TDS/Touring 725 TDS Omega TDS Range Rover</i></p>	<p>18-6592090 STD -mm 18-6592093 0,50 mm</p>	<p>A = 39,450 B = 62,450 C = 2,500</p> <p>Ring Carrier Oil Gallery Steel Support Oil Cut-Out</p>	<p>RE15140000 -STD RE15140050 -0,50 RE15140100 -1,00</p> <p>3,000 (504) Cr 1,750 (501) P IFU 3,000 (604) Cr</p>	<p>ø27,0 x 63,0</p>			
<p>ø80,00</p> <p>4 Cyl. Diesel 1870 cc 74 Kw (100Ps)18.3: Turbo, Intercooler F9Q, Turbo Intercooler <u>2000 -...</u></p> <p><i>Kangoo 1.9 Tdi Megane 1.9 Tdi Laguna 1.9 Tdi Scenic 1.9 Tdi Traffic 1.9 Tdi Carisma 1.9 GDI Vivaro 1,9 CDTI 8 v</i></p>	<p>18-8050940 STD -mm 18-8050943 0,50 mm</p>	<p>A = 47,060 B = 77,000 C = 17,800 E = -0,750 CD= 38,000</p> <p>Ring Carrier Oil Cut-Out</p>	<p>RE49380000 -STD RE49380050 -0,50</p> <p>2,500 (500) CKP 2,000 (501) P 3,000 (604) Cr</p>	<p>ø28,0 x 60,0</p>			<p>+0,60 +0,80</p>

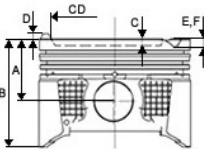
Engine	Ref. No. - Kit 1	Dimensions	Rings	Pin	Piston Liner	Kit 2	Info
<p>ø80,50</p> <p>R 4 Gasoline, 1796 cm³ 79 92 kW (107 125 PS) X18XE1 Z18XE Z18ZEL <u>1998-2005</u></p> <p>Astra Zafira Vectra Corsa Meriva Tigra</p>	<p>18-3010800 STD -mm 18-3010803 0,50 mm</p>	<p>A = 24,100 B = 44,700</p>	<p>RE43370000 -STD RE43370050 -0,50 RE43370100 -1,00</p> <p>1,200 (500) NitB S IF 1,200 (508) P 2,000 (700) Nit S</p>	<p>ø18,0 x 55,0</p>			
<p>ø80,50</p> <p>R 4 Petrol, 1796 cm³ 85 kW (115 hp) Z18XER <u>2000-.....</u></p> <p>Astra H 1.8i 16V Zafira B 1.8i 16V Vectra C 1.8i 16V Signum 1.8i 16V</p>	<p>18-3010830 STD -mm 18-3010833 0,50 mm 18-3010838 1,00 mm</p>	<p>A = 26,100 B = 45,100 D = 0,700</p> <p>Hard Anodising</p>	<p>RE43370000 -STD RE43370050 -0,50 RE43370100 -1,00</p> <p>1,200 (500) NitB S IF 1,200 (508) P 2,000 (700) Nit S</p>	<p>ø19,0 x 50,0</p>			







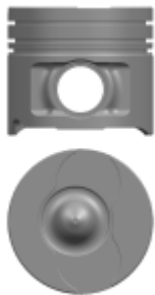



Engine	Ref. No. - Kit 1	Dimensions	Rings	Pin	Piston Liner	Kit 2	Info
<p>ø81,60</p> <p>R 4 Petrol, 1796 cm³ 92 kW (125 hp) C18XE C18XEL <u>1993-2000</u> Astra F Vectra B</p>	<p>18-3010790 STD -mm 18-3010793 0,50 mm</p>	<p>A = 30,400 B = 50,400 C = 1,840 E = -1,790 CD= 50,800</p>	<p>RE43140000 -STD RE43140050 -0,50 RE43140100 -1,00</p> <p>1,500 (500) CrB S IF 1,500 (508) P 3,000 (700) Cr P S</p>	<p>ø21,0 x 61,5</p>			
<p>ø81,60</p> <p>6 Cyl. Gasoline 2498 cc 125 Kw (170 Ps) C2.5XE X2.5XE <u>1993 -....</u> Omega B 2,5 24v Vectra B 2,5 24v Calibra 2,5l 24v Carlton 2,5l</p>	<p>18-3010810 STD -mm 18-3010813 0,50 mm</p>	<p>A = 30,450 B = 50,400 D = 0,630 E = -2,000</p>	<p>RE43140000 -STD RE43140050 -0,50 RE43140100 -1,00</p> <p>1,500 (500) CrB S IF 1,500 (508) P 3,000 (700) Cr P S</p>	<p>ø21,0 x 56,0</p>			

							
Engine	Ref. No. - Kit 1	Dimensions	Rings	Pin	Piston Liner	Kit 2	Info
<p>ø82,00</p> <p>4 Cyl. Diesel 1910 cc 77 Kw (103 Ps) Z19DT 182B.9000 <u>2001 -....</u> Doblo 1.9 JTD</p>	<p>18-3051940 STD -mm 18-3051942 0,40 mm 18-3051947 0,80 mm</p>	<p>A = 46,500 B = 72,500 C = 17,450 E = -0,650 CD= 37,550</p> <p>Ring Carrier Bushing</p>	<p>RE22730000 -STD RE22730040 -0,40 RE22730060 -0,60 RE22730080 -0,80 RE22730100 -1,00</p> <p>2,000 (500) Cr P 2,000 (508) P 2,000 (604) Cr P</p>	<p>ø26,0 x 61,0</p>			<p>0,77 0,87mm Gasket +0,014 +0,104</p> <p>0,87 0,97mm Gasket +0,105 +0,205</p> <p>0,97 1,07mm Gasket +0,236 +0,294</p>
<p>ø82,00</p> <p>4 Cyl. Diesel 1900 cc 110 Kw 1/9 JTD Euro 4 16 V <u>2000 -....</u> Astra Zafira Vectra&Signum Signum Vectra Zafira Doblo 1.9 JTD Bravo 1.9 JTD Stilo 1.9 JTD</p>	<p>18-3083440 STD -mm 18-3083442 0,40 mm</p>	<p>A = 46,500 B = 72,500 C = 15,400 E = -1,070 F = -1,020 CD= 41,500</p> <p>Ring Carrier Oil Gallery</p>	<p>RE22730000 -STD RE22730040 -0,40 RE22730060 -0,60 RE22730080 -0,80 RE22730100 -1,00</p> <p>2,000 (500) Cr P 2,000 (508) P 2,000 (604) Cr P</p>	<p>ø30,0 x 67,0</p>			

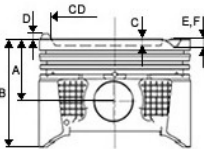











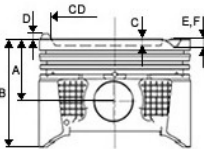



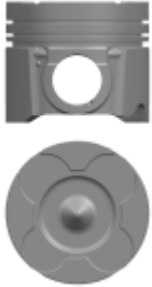

Engine	Ref. No. - Kit 1	Dimensions	Rings	Pin	Piston Liner	Kit 2	Info
<p>ø82,50</p> <p>R 4 Diesel, 1699 cm³ 50 kW (68 PS), 22:1 Turbo, LLK, 8 Ventile X17DTL X17DTL <u>1994-2006</u></p> <p>ASTRA-F 1.7 TD ASTRA-G 1.7 TD ASTRAVAN III 1.7 TD</p>	<p>14-3050920 STD -mm 14-3050923 0,50 mm 14-3050928 1,00 mm</p>	<p>A = 68,816 B = 72,950 C = 1,600</p> <p>Hard Anodising Steel Support</p>	<p>RE43150000 -STD RE43150050 -0,50 RE43150100 -1,00</p> <p>2,000 (500) Cr 2,000 (501) P 3,000 (604) Cr</p>	<p>ø26,0 x 65,0</p>			
<p>ø82,50</p> <p>4 Cyl. Diesel 1700 cc 42 Kw (57 Ps) 23:1 17D 17DR <u>1988-1995</u></p> <p>ASTRA-F 1.7 D ASTRAVAN III 1.7 D KADETT-E 1.7 D VECTRA-A 1.7 D COMBO 1,7 D,</p>	<p>18-3050960 STD -mm 18-3050963 0,50 mm 18-3050968 1,00 mm</p>	<p>A = 44,950 B = 72,950 C = 0,350</p> <p>Ring Carrier Hard Anodising Steel Support</p>	<p>RE43150000 -STD RE43150050 -0,50 RE43150100 -1,00</p> <p>2,000 (500) Cr 2,000 (501) P 3,000 (604) Cr</p>	<p>ø26,0 x 65,0</p>			<p>1.30 mm Gasket 0 +0,75</p> <p>1.40 mm Gasket +0,75 +0,85</p> <p>1.50 mm Gasket +0,85 +1,05</p>

Engine	Ref. No. - Kit 1	Dimensions	Rings	Pin	Piston Liner	Kit 2	Info
<p>ø83,00</p> <p>4 Cyl. Diesel 1991cc 110 Kw(150 BG) Z20S Z20DMH <u>2006 -</u></p> <p>CAPTIVA 2.0 16V D ANTARA 2.0 CDTI 16V</p>	<p>18-1092500 STD -mm 18-1092503 0,50 mm</p>	<p>A = 46,350 B = 72,350 C = 13,950 CD= 46,700</p> <p>Ring Carrier Oil Gallery</p>	<p>RE43460000 -STD RE43460000_NPR -STD RE43460050 -0,50</p> <p>2,000 (505) Nit S 2,000 (501) P 3,000 (604) Nit S</p>	<p>ø28,0 x 66,8</p>			<p>1 Notch 0.11 0.23</p> <p>2 Notch 0.24 0.33</p> <p>3 Notch 0.34 0.42</p>
<p>ø83,00</p> <p>4 Cyl. Diesel 1956 cc 100 125 KW 136 170Ps 16,5:1 198 A5.000 A 20DTH 939B 5.000/940A 5.000 <u>2008 -</u></p> <p>Freemont Astra J Insignia 2.0 CDTI 16V Zafira MK III 2.0 CDTI</p>	<p>18-2092650 STD -mm 18-2092652 0,40 mm 18-2092653 0,50 mm</p>	<p>A = 46,630 B = 72,630 C = 15,800 E = -1,171 F = -1,220 CD= 43,500</p> <p>Ring Carrier Oil Gallery</p>	<p>RE43510000 -STD RE43510040 -0,40 RE43510050 -0,50</p> <p>1,500 (500) Cr P 1,500 (508) P 2,000 (604) Nit S</p>	<p>ø30,0 x 67,0</p>			

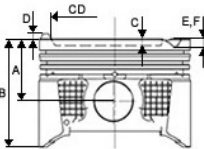







							
Engine	Ref. No. - Kit 1	Dimensions	Rings	Pin	Piston Liner	Kit 2	Info
<p>ø84,00</p> <p>4 Cyl. Diesel 1998 cc 60 Kw (82 Ps) 18,7:1 Turbo, Intercooler 24v X20DTL Y20DTL <u>1996-2004</u></p> <p>Astra F 16v Astra G 16v Omega B 26v Vectra B 16v</p>	<p>18-3050970 STD -mm 18-3050973 0,50 mm</p>	<p>A = 45,800 B = 70,800 C = 14,840 E = -1,000 CD= 41,000</p> <p>Ring Carrier</p>	<p>RE43330000 -STD RE43330050 -0,50</p> <p>2,000 (500) CrB S 1,750 (508) P 3,000 (604) Nit S</p>	<p>ø29,0 x 68,0</p>			<p>STD Gasket +0,40 + 0,50</p> <p>1NotchGasket +0,51 +0,60</p> <p>2NotchGasket +0,61 +0,70</p>
<p>ø84,00</p> <p>4 Cyl. Diesel 1998 cc 74 Kw (100 Ps) 19,5:1 Turbo, Intercooler 24 v X20DTH <u>1997-2004</u></p> <p>Zafira 16v Astra G 16v Omega B 16v Vectra B 16v</p>	<p>18-3050980 STD -mm 18-3050983 0,50 mm</p>	<p>A = 45,800 B = 70,800 C = 14,610 E = -1,000 CD= 41,000</p> <p>Ring Carrier Oil Cut-Out</p>	<p>RE43340000 -STD RE43340050 -0,50</p> <p>2,500 (505) Cr P 1,750 (508) P 3,000 (604) Nit S</p>	<p>ø29,0 x 68,0</p>			<p>STD Gasket +0,40 +0,50</p> <p>1Notch Gasket +0,51 +0,60</p> <p>2Notch Gasket +0,61 +0,70</p>



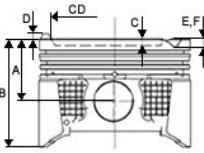







							
Engine	Ref. No. - Kit 1	Dimensions	Rings	Pin	Piston Liner	Kit 2	Info
<p>ø84,00</p> <p>4 Cyl. Diesel 2172 cc 81/85/86/88/92 kW 110/116/117/120/125 PS X22DTH Y22DTH Y22DTR</p> <p>..... -</p> <p><i>Frontera B 2.2 DTI Sintra 2.2 DTI Omega B 2.2 DTI 16V Astra G 2.2 DTI Signum 2.2 DTI/16V Vectra B/C/GTS 2.2 DTI Zafira A 2.2 DTI 16V</i></p> 	<p>18-3092930 STD -mm 18-3092933 0,50 mm</p>	<p>A = 45,800 B = 70,800 C = 14,670 E = -1,050 CD= 43,000</p> <p>Ring Carrier Oil Gallery Oil Cut-Out</p>	<p>RE43350000 -STD RE43350050 -0,50 RE43350100 -1,00</p> <p>1,750 (500) Cr P 1,750 (501) P 3,000 (604) Cr P</p>	<p>ø29,0 x 68,0</p>			
<p>ø84,00</p> <p>4 Cyl. Diesel 1995 cc 74 Kw (101 Ps) 18,5:1 Turbo, Intercooler 24 v Y20DTH</p> <p><u>08/2002 -.....</u></p> <p><i>ASTRA 2.0 DTI GLS ASTRA 2.0 DTI ASTRA-G 2.0 DI ASTRAVAN IV 2.0 DTI SIGNUM 2.0 DTI VECTRA I/II 2. DTI ZAFIRA I 2.0 DTI</i></p>	<p>14-3092990 STD -mm 14-3092993 0,50 mm</p>	<p>A = 45,800 B = 70,800 C = 14,900 E = -1,000 CD= 41,000</p>	<p>RE43350000 -STD RE43350050 -0,50 RE43350100 -1,00</p> <p>1,750 (500) Cr P 1,750 (501) P 3,000 (604) Cr P</p>	<p>ø29,0 x 62,0</p>			

							
Engine	Ref. No. - Kit 1	Dimensions	Rings	Pin	Piston Liner	Kit 2	Info
<p>ø84,80</p> <p>R 4 Gasoline, 1796 cm³ 60 74 kW (82 101 PS) 18S Z18XER <u>1986-1988</u></p> <p>Astra Corca Kadett Vectra</p>	<p>14-3010490 STD -mm 14-3010493 0,50 mm</p>	<p>A = 33,650 B = 53,650 C = 5,000 CD= 52,000</p>	<p>RE43160000 -STD RE43160050 -0,50 RE43160100 -1,00</p> <p>1,500 (500) CrB S IF 1,500 (508) P 3,000 (700) Cr S P</p>	<p>ø21,0 x 61,5</p>			
<p>ø84,80</p> <p>R 4 Gasoline, 1796 cm³ 63 85 kW (86 115 PS) 18E 18SV <u>1982-1994</u></p> <p>Astra Kadett Omega Vectra</p>	<p>18-3010590 STD -mm 18-3010593 0,50 mm</p>	<p>A = 33,650 B = 53,650 C = 4,000 CD= 41,000</p>	<p>RE43160000 -STD RE43160050 -0,50 RE43160100 -1,00</p> <p>1,500 (500) CrB S IF 1,500 (508) P 3,000 (700) Cr S P</p>	<p>ø21,0 x 61,5</p>			

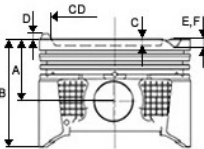









							
Engine	Ref. No. - Kit 1	Dimensions	Rings	Pin	Piston Liner	Kit 2	Info
<p>ø86,00</p> <p>R 4 Petrol, 2198 cm³ 106 kW (144 hp), 10,5: Y22XE Z22XE <u>1993-2003</u></p> <p><i>Omega B 2.2 16V</i> <i>Omega 2.2 16V</i></p>	<p>18-3010610 STD -mm 18-3010613 0,50 mm</p>	<p>A = 27,600 B = 55,000 D = 2,400</p>	<p>RE43430000 -STD RE43430050 -0,50</p> <p>1,200 (500) NitB S 1,500 (508) P 2,500 (700) Cr P S</p>	<p>ø21,0 x 61,5</p>			
<p>ø86,00</p> <p>R 4 Gasoline, 1998 cm³ 85 115 kW X20SE 20SE 20SEH 20SER 20XE 20XEJ <u>1986-2000</u></p> <p><i>Astra</i> <i>Kadett</i> <i>Omega</i></p>	<p>14-3010620 STD -mm 14-3010623 0,50 mm</p>	<p>A = 30,400 B = 55,400 C = 5,000 CD= 45,000</p>	<p>RE43190000 -STD RE43190050 -0,50 RE43190100 -1,00</p> <p>1,500 (500) CrB S 1,500 (501) P 3,000 (700) Cr P S</p>	<p>ø21,0 x 61,5</p>			

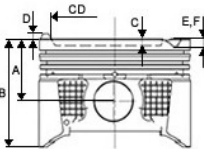









							
Engine	Ref. No. - Kit 1	Dimensions	Rings	Pin	Piston Liner	Kit 2	Info
<p>ø86,00</p> <p>R 4 Gasoline, 1998 cm³ 85 95 kW 20NE C20NE <u>1986-1998</u></p> <p><i>Omega Kadett Ascona Vectra Le Mans 2,0 Espero 2,0 Frontera</i></p>	<p>18-3010630 STD -mm 18-3010633 0,50 mm 18-3010638 1,00 mm</p>	<p>A = 30,400 B = 55,400 C = 5,000 CD= 57,000</p> <p>Steel Support</p>	<p>RE43190000 -STD RE43190050 -0,50 RE43190100 -1,00</p> <p>1,500 (500) CrB S 1,500 (501) P 3,000 (700) Cr P S</p>	<p>ø21,0 x 61,5</p>			
<p>ø86,00</p> <p>2.2 i 16v Z22SE <u>2000-2005</u></p> <p><i>Omega Kadett Ascona Vectra Zafira Astra</i></p>	<p>18-3010710 STD -mm 18-3010713 0,50 mm 18-3010718 1,00 mm</p>	<p>A = 26,750 B = 48,900 C = 0,610 CD= 70,000</p> <p>Hard Anodising</p>	<p>RE43430000 -STD RE43430050 -0,50</p> <p>1,200 (500) NitB S 1,500 (508) P 2,500 (700) Cr P S</p>	<p>ø20,0 x 62,0</p>			

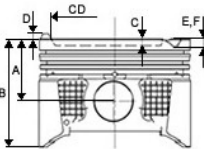









							
Engine	Ref. No. - Kit 1	Dimensions	Rings	Pin	Piston Liner	Kit 2	Info
<p>ø86,00</p> <p>V 6 Petrol, 2962 cm³ 155 kW (211 hp), 10 X30XE <u>1994-2001</u> <i>Omega B 24v Sintra Carlton</i></p>	<p>14-3010720 STD -mm</p>	<p>A = 26,750 B = 48,900 C = 0,610 CD= 70,000</p>	<p>RE43190000 -STD RE43190050 -0,50 RE43190100 -1,00</p> <p>1,500 (500) CrB S 1,500 (501) P 3,000 (700) Cr P S</p>	<p>ø21,0 x 65,0</p>			
<p>ø86,00</p> <p>2.0i 2.2i X22XE X22SE <u>1998-2000</u> <i>Omega Kadett Ascona Vectra Leganza Frontera</i></p>	<p>18-3010730 STD -mm 18-3010733 0,50 mm</p>	<p>A = 30,400 B = 55,400 C = 6,500 CD= 63,180</p>	<p>RE43190000 -STD RE43190050 -0,50 RE43190100 -1,00</p> <p>1,500 (500) CrB S 1,500 (501) P 3,000 (700) Cr P S</p>	<p>ø21,0 x 61,5</p>			

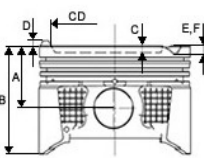

							
Engine	Ref. No. - Kit 1	Dimensions	Rings	Pin	Piston Liner	Kit 2	Info
<p>ø86,00</p> <p>R 4 Gasoline, 1998 cm³ 110 kW (150 PS) C20XE <u>1991-1998</u></p> <p><i>Omega Kadett Ascona Vectra Leganza</i></p>	<p>14-3010740 STD -mm</p>	<p>A = 30,430 B = 55,430 C = 0,850 E = -1,930 CD= 70,000</p>	<p>RE43190000 -STD RE43190050 -0,50 RE43190100 -1,00</p> <p>1,500 (500) CrB S 1,500 (501) P 3,000 (700) Cr P S</p>	<p>ø21,0 x 61,5</p>			
<p>ø86,00</p> <p>4 Cyl. Gasoline 1998 cc 82 Kw (112 Ps) 9,2:1 Catal.Conv, 16 v X20XEV C20XEV <u>1994-2000</u></p> <p><i>Omega Kadett Ascona Vectra</i></p>	<p>18-3010780 STD -mm 18-3010783 0,50 mm 18-3010788 1,00 mm</p>	<p>A = 30,400 B = 55,400 C = 3,160 E = -1,650 CD= 59,000</p>	<p>RE43190000 -STD RE43190050 -0,50 RE43190100 -1,00</p> <p>1,500 (500) CrB S 1,500 (501) P 3,000 (700) Cr P S</p>	<p>ø21,0 x 61,5</p>			



							
Engine	Ref. No. - Kit 1	Dimensions	Rings	Pin	Piston Liner	Kit 2	Info
<p>ø87,00</p> <p>4 Cyl. Diesel 2188cc 66 Kw(90 Ps) 18:1 Turbo , Intercooler C.Rail G9T 722/720/750 <u>2000 -....</u></p> <p><i>(Turbo-Intercooler/C.Rail)</i> Movano 2.2 DTI 16v Espace IV 2.2 TDCI Laguna 2.2 TDCI Master 2.2 TDCI Velsatis 2.2 TDCI</p>	<p>18-8050330 STD -mm 18-8050333 0,50 mm</p>	<p>A = 54,530 B = 84,200 C = 17,500 E = -1,600 F = -2,000 CD= 40,400</p> <p>Ring Carrier Oil Cut-Out</p>	<p>RE49440000 -STD RE49440050 -0,50</p> <p>3,000 (503) CKP 1,750 (501) P 2,500 (604) P</p>	<p>ø31,0 x 65,0</p>			<p>+0.6 +0.40</p>
<p>ø89,00</p> <p>4 Cyl. Diesel 2463 cc 84 Kw (115 Ps) 17.75:1 Common Rail G9U Euro 3 720/724/730/750/754 <u>2001-2006</u></p> <p>Master II 2,5 Dci OPEL/Movano Box Movano Platform Vivaro Box Vivaro Platform</p>	<p>18-3050290 STD -mm 18-3050290-20 STD -mm (0.2 mm SHORT) 18-3050293 0,50 mm 18-3050293-20 0,50 mm (0.2 mm SHORT)</p>	<p>A = 53,030 B = 83,090 C = 17,850 E = -1,600 F = -2,000 CD= 43,200</p> <p>Ring Carrier Oil Cut-Out</p>	<p>RE49450000 -STD RE49450050 -0,50</p> <p>2,500 (500) Cr P IF 1,750 (501) P IFU 2,500 (604) Cr P</p>	<p>ø31,0 x 65,0</p>			<p>+0,35 +0,60</p>

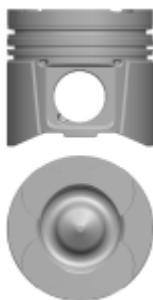
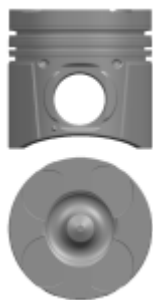









Engine	Ref. No. - Kit 1	Dimensions	Rings	Pin	Piston Liner	Kit 2	Info
<p>ø89,00</p> <p>4 Cyl. Diesel 2463 cc 84 Kw (115 Ps) 17.75 G9U Euro 4 632/650 <u>2001-2006</u></p> <p><i>Master II 2,5 Dci OPEL/Movano Box Movano Platform Vivaro Box Vivaro Platform</i></p>	<p>18-3050300 STD -mm 18-3050303 0,50 mm</p>	<p>A = 53,075 B = 83,090 C = 16,130 E = -1,600 F = -2,000 CD= 48,000</p> <p>Ring Carrier</p>	<p>RE49490000 -STD RE49490050 -0,50</p> <p>3,000 (503) Cr P 1,750 (508) P 2,500 (604) Nit S</p>	<p>ø31,0 x 65,0</p>			
<p>ø89,00</p> <p>4 Diesel, 2464 cm³ 74/107 kW (101/146 PS) 18:1 18,1:1,16 Ventile G9U 630 G9U 632 G9U 650 <u>10/2003</u></p> <p><i>INTERSTAR DCI 100/120/150 PRIMASTAR DCI 150 MOVANO-A 2.5 CDTI VIVARO 2.5 CDTI/DTI TRAFIC II 2.5 DCI MASTER II 2.5 DCI</i></p>	<p>18-3092350 STD -mm 18-3092351 0,25 mm 18-3092353 0,50 mm</p>	<p>A = 53,075 B = 83,090 C = 16,300 E = -2,000 F = -1,700 CD= 48,000</p> <p>Ring Carrier Oil Gallery Oil Cut-Out</p>	<p>RE49490000 -STD RE49490050 -0,50</p> <p>3,000 (503) Cr P 1,750 (508) P 2,500 (604) Nit S</p>	<p>ø31,0 x 68,0</p>			



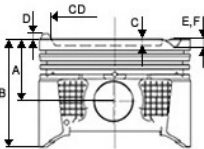





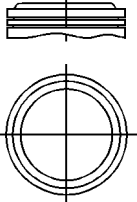

Engine	Ref. No. - Kit 1	Dimensions	Rings	Pin	Piston Liner	Kit 2	Info
<p>ø90,00</p> <p>4 Cyl. Diesel 2112 cc 46/43/48/55/78 Kw (59/63/56/75/95/106 Ps) XD4.90 XDP4.90 XDP6.90WTA <u>1969....</u></p> <p><i>J 7 2.1 D</i> <i>504 2.1 D</i> <i>J 9 2.1 D</i> <i>J 7 2.1 D</i> <i>Granada 2.1 D</i> <i>Blitz 2.1 D</i></p>	<p>14-7550940 STD -mm 14-7550943 0,50 mm 14-7550948 1,00 mm</p>	<p>A = 57,200 B = 96,350 C = 2,000</p>	<p>RE47170000 -STD RE47170050 -STD RE47170100 -STD</p> <p>2,000 (500) Cr 2,000 (501) P 2,000 (508) P 4,500 (604) P</p>	<p>ø28,0 x 77,0</p>			
<p>ø93,00</p> <p>4 Cyl. Gasoline 1897 cc 65/66/78KW (88/90/107 PS) 8,8:1 19E 19S 19SH <u>1965 - 1981</u></p> <p><i>1.9</i> <i>ASCONA A/B</i> <i>GT</i> <i>KADETT B/C</i> <i>MANTA A/B</i> <i>OLYMPIA</i> <i>REKORD S/SPRINT/1900</i> <i>CAVALIER 1.5</i></p>	<p>18-3010520 STD -mm 18-3010522 0,20 mm 18-3010523 0,50 mm 18-3010528 1,00 mm 18-301052X 0,30 mm 18-301052Z 0,20 mm</p>	<p>A = 45,000 B = 87,000 E = -3,500</p>	<p>RE43280000 -STD RE43280020 -0,20 RE43280030 -0,30 RE43280040 -0,40 RE43280050 -0,50 RE43280100 -1,00</p> <p>2,000 (500) Cr P IF 2,000 (506) P 5,000 (700) Cr P S</p>	<p>ø23,0 x 70,0</p>			

Engine	Ref. No. - Kit 1	Dimensions	Rings	Pin	Piston Liner	Kit 2	Info
<p>ø93,00</p> <p>4 Cyl. Diesel 2499 cc 62 Kw (85 Ps) Atmospheric SOFIM 2/5 Düz <u>2001 -....</u></p> <p><i>Ducato 2.5 D Movano 2.5 D Master 2.5 D</i></p>	<p>18-3051880 STD -mm <i>18-3051880-20 STD -mm (0.2 mm SHORT)</i></p> <p>18-3051882 0,40 mm <i>18-3051882-20 0,40 mm (0.2 mm SHORT)</i></p>	<p>A = 54,000 B = 89,000 C = 2,200</p> <p>Ring Carrier Hard Anodising Oil Cut-Out</p>	<p>RE22340000 -STD RE22340040 -0,40 RE22340060 -0,60</p> <p>3,000 (504) Cr P 2,000 (501) P 3,000 (604) Cr P</p>	<p>ø32,0 x 68,0</p>			<p>+0,40 +0,50 1.20 mm Gasket</p> <p>+0,51 +0,60 1.30 mm Gasket</p> <p>+0,61 +0,70 1.40 mm Gasket</p>
<p>ø94,40</p> <p>4 Cyl. Diesel 2798 cc 76 Kw (103 Ps) 18,5:1 Sofim Turbo, Intercooler Euro 2 SOFIM TurboS9W700 702</p> <p><u>1996 -....</u></p> <p><i>Movano 2.8 TD Ducato 2.8 TD 49.10 49.12 M14 Minibus Turbo Daily35.12 Motor No: 2572280 --> Boxer 2.8 TD Master 2.8 TDI Jumper 2.8 TD</i></p>	<p>18-3051670 STD -mm <i>18-3051670-20 STD -mm (0.2 mm SHORT)</i></p> <p>18-3051672 0,40 mm <i>18-3051672-20 0,40 mm (0.2 mm SHORT)</i></p> <p>18-3051674 0,60 mm <i>18-3051674-20 0,60 mm (0.2 mm SHORT)</i></p>	<p>A = 58,750 B = 87,600 C = 19,400 CD= 39,500</p> <p>Ring Carrier Oil Gallery Oil Cut-Out</p>	<p>RE22780000 -STD RE22780040 -0,40 RE22780060 -0,60</p> <p>2,500 (504) Cr P 2,000 (501) P 2,500 (604) Cr P</p>	<p>ø32,0 x 72,0</p>			<p>1,20 mm Gasket +0,40 +0,50</p> <p>1,30 mm Gasket +0,51 +0,60</p> <p>1,40 mm Gasket + 0,61 +0,70</p>

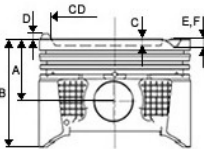
Engine	Ref. No. - Kit 1	Dimensions	Rings	Pin	Piston Liner	Kit 2	Info
<p>ø95,00</p> <p>4/6 Cyl. Gasoline 1979/2969 cc 74/130/135 kW (100/177 PS) 9,4:1 8/12 Ventile 20E 20S 30E 30NE</p> <p><u>1975 - 1990</u></p> <p>(2.0) ASCONA A/B GT KADETT C MANTA BE/BS OLYMPIA REKORD 2.0/E/S (3.0) MONZA-A OMEGA-A SENATOR I/II-A/B CARLTON II/III 1.9/2.0 I/3.0 CAVALIER I/II 2.0/SROYALE 2.9/3.0</p>	<p>18-3010530 STD -mm 18-3010533 0,50 mm 18-3010538 1,00 mm</p> 	<p>A = 45,000 B = 87,000 E = -3,500</p>	<p>RE43310000 -STD RE43310050 -0,50 RE43310100 -1,00</p> <p>2,000 (500) CrB S 2,000 (508) P 4,000 (700) P</p>	<p>ø23,0 x 68,0</p>			

							
Engine	Ref. No. - Kit 1	Dimensions	Rings	Pin	Piston Liner	Kit 2	Info
<p>ø70,00</p> <p>4 Cyl. Gasoline 954 cc 31/33/37 42/45/50 ps TU9M/Z <u>1992 -</u> <i>205 1.0i</i> <i>106 1.0i</i></p>	<p>14-7510510 STD -mm</p>	<p>A = 33,900 B = 58,000 D = 0,800</p>	<p>RE47360000 -STD RE47360050 -0,50</p> <p>1,500 (500) CrBSIF 1,500 (501) P 3,000 (700) CrPS</p>	<p>ø18,0 x 53,0</p>			
<p>ø72,00</p> <p>R 4 Petrol, 1124 cm³ 37 kW (50 hp), 9,7:1 XW7 <u>1981 - 1986</u> <i>104</i> <i>205</i></p>	<p>14-7510070 STD -mm</p> 	<p>A = 40,050 B = 73,700 D = 4,200</p>	<p>RE18020000 -STD</p> <p>1,500 (500) Cr S 2,000 (501) P 4,000 (700) Cr P S</p>	<p>ø19,5 x 62,0</p>			

Engine	Ref. No. - Kit 1	Dimensions	Rings	Pin	Piston Liner	Kit 2	Info
<p>ø72,00</p> <p>R 4 Petrol, 1124 cm³ 40 kW (54 hp) TU1 E1 A TU1K TU 1M XW3 XW3S XW7/A</p> <p><u>1988-1992</u></p> <p>106 205 306 309 Partner</p>	<p>14-7510130 STD -mm</p>	<p>A = 40,000 B = 67,000 D = 3,000</p>	<p>RE18020000 -STD</p> <p>1,500 (500) Cr S 2,000 (501) P 4,000 (700) Cr P S</p>	<p>ø19,5 x 62,0</p>			
<p>ø73,70</p> <p>4 Cyl. Diesel 1399 cc 50 Kw (68 Ps) DV4TD DV4 TED DV4C TED F6JA F6JB 8HX 8HR 8HZ 8HS</p> <p><u>2002 -....</u></p> <p>Fiesta V 1.4 TDCI Fusion 1.4 TDCI Mazda 2 1,4D C2 1.4 HDI C3 1.4 HDI XSARA 1.4 HDI NEMO 1.4 HDI 1007 1.4 HDI 107 1.4 HDI 206 1.4 HDI 207 1.4 HDI 307 1.4 HDI BIPPER 1.4 HDI</p>	<p>18-2550150 STD -mm 18-2550150-20 STD -mm (0.2 mm SHORT) 18-2550150-40 STD -mm (0.4 mm SHORT)</p> <p>18-2550153 0,50 mm 18-2550153-20 0,50 mm (0.2 mm SHORT) 18-2550153-40 0,50 mm (0.4 mm SHORT)</p>	<p>A = 42,940 B = 65,440 C = 14,700 CD= 37,200</p> <p>Ring Carrier</p>	<p>RE23050000 -STD RE23050050 -0,50</p> <p>2,500 (505) CrB P 1,950 (508) P IFU 2,500 (604) Cr P</p>	<p>ø25,0 x 60,0</p>			

							
Engine	Ref. No. - Kit 1	Dimensions	Rings	Pin	Piston Liner	Kit 2	Info
<p>ø73,70</p> <p>4 Cyl. Diesel 1398cc 68 HP 50 KW DV4C Euro 5 <u>2010 -</u> <i>Fiesta V 1.4 TDCI</i></p>	<p>18-2550160 STD -mm 18-2550163 0,50 mm</p>	<p>A = 42,900 B = 65,400 C = 12,500 CD= 45,100</p> <p>Ring Carrier Oil Cut-Out</p>	<p>RE23580000 -STD RE23580050 -0,50</p> <p>2,500 (514) Cr P 1,950 (508) P IFU 2,000 (604) Nit S</p>	<p>ø25,0 x 60,0</p>			
<p>ø73,70</p> <p>R 4 Diesel, 1398 cm³ 50/66kW (68PS/90PS) 17,5:1,16 Ventile,T 8HY (DV4TED4) 8HS (DV4TED), Euro 4 <u>02/2002...04/2005</u> <i>C3 I 1.4 HDI Peugeot Turbo</i></p>	<p>18-7592160 STD -mm 18-7592161 0,25 mm 18-7592163 0,50 mm</p>	<p>A = 42,940 B = 65,440 C = 14,390 E = -1,180 CD= 37,160</p> <p>Ring Carrier Oil Gallery Oil Cut-Out</p>	<p>RE23050000 -STD RE23050050 -0,50</p> <p>2,500 (505) CrB P 1,950 (508) P IFU 2,500 (604) Cr P</p>	<p>ø24,9 x 60,0</p>			

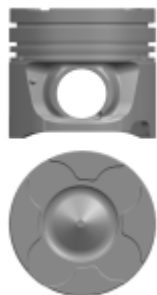
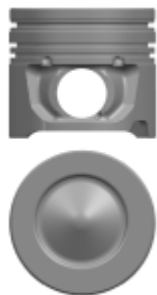

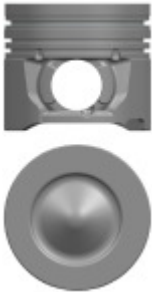
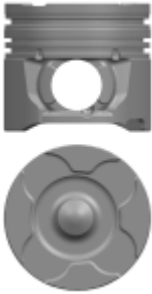
Engine	Ref. No. - Kit 1	Dimensions	Rings	Pin	Piston Liner	Kit 2	Info
<p>ø75,00</p> <p>4 Cyl. Diesel 1560cc 70 Kw (95 Ps) 1.6 HDi (DV6C) EUR5 1.6 HDi (DV6D) Euro 4 <u>2011 -</u></p> <p><i>FOCUS</i> <i>BERLINGO 1.6 8V</i> <i>C4 (B7)</i> <i>DS4 (9HR-9HL)</i> <i>DS5</i> <i>Grand Picasso II</i> <i>C4</i> <i>DS4</i> <i>DS3</i> <i>C3</i> <i>C3 II</i> <i>3008</i> <i>308</i> <i>5008</i> <i>508</i> <i>Partner</i> <i>Tepee</i> <i>2008</i> <i>308 SW</i> <i>207 SW</i> <i>208</i> <i>207</i></p> 	<p>18-2581660 STD -mm <i>18-2581660-20 STD -mm</i> <i>(0.2 mm SHORT)</i> 18-2581663 0,50 mm <i>18-2581663-20 0,50 mm</i> <i>(0.2 mm SHORT)</i> <i>18-2581663-40 0,50 mm</i> <i>(0.4 mm SHORT)</i></p>	<p>A = 41,750 B = 65,200 C = 13,850 CD= 45,000</p> <p>Ring Carrier Oil Gallery Oil Cut-Out</p>	<p>RE23550000 -STD RE23550050 -0,50</p> <p>2,500 (514) Cr P 1,950 (508) P 2,000 (604) Nit S</p>	<p>ø26,0 x 61,0</p>			<p>1 Notch 0,5 mm 0,63 mm</p> <p>2 Notch 0,63 mm 0,68 mm</p> <p>3 Notch 0,68 mm 0,73 mm</p> <p>4 Notch 0,73 mm 0,78 mm</p> <p>5 Notch 0,78 mm 0,88 mm</p>
<p>ø75,00</p> <p>4 Cyl. Diesel 1560 cc 80 Kw (109 Ps) DV6TD/TED <u>2004 -....</u></p> <p><i>Expert 1,6 HDI</i> <i>307 1,6 HDI</i> <i>206 1,6 HDI</i> <i>C4 1,6 HDI</i> <i>Jumpy 1,6 HDI</i> <i>C-Max 1,6 HDI</i> <i>Focus 1,6 HDI</i></p> 	<p>18-2591770 STD -mm <i>18-2591770-20 STD -mm</i> <i>(0.2 mm SHORT)</i> 18-2591773 0,50 mm <i>18-2591773-20 0,50 mm</i> <i>(0.2 mm SHORT)</i> <i>18-2591773-40 0,50 mm</i> <i>(0.4 mm SHORT)</i> 18-2591774 0,60 mm <i>18-2591774-20 0,60 mm</i> <i>(0.2 mm SHORT)</i> <i>18-2591774-40 0,60 mm</i> <i>(0.4 mm SHORT)</i></p>	<p>A = 41,700 B = 65,300 C = 13,250 E = -1,200 CD= 41,800</p> <p>Ring Carrier Oil Gallery Oil Cut-Out</p>	<p>RE47460000 -STD RE47460040 -0,40 RE47460050 -0,50 RE47460060 -0,60</p> <p>3,000 (505) CKP 1,950 (508) P 2,500 (604) CrP</p>	<p>ø26,0 x 61,0</p>			<p>1.35 mm Gasket +0,68 +0,73</p> <p>1.25 mm Gasket +0,53 +0,63</p> <p>1.30 mm Gasket +0,63 +0,68</p> <p>1.40 mm Gasket +0,73 +0,78</p> <p>1.45 mm Gasket +0,78 +0,88</p>

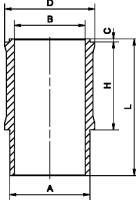
Engine	Ref. No. - Kit 1	Dimensions	Rings	Pin	Piston Liner	Kit 2	Info
<p>ø75,00</p> <p>R 4 Petrol, 1361 cm³ 55 kW (75 hp), 10,5:1 Düz Tepe TU3JPL4 KFW(TU3JP) KFX(TU3JP) <u>2004 -....</u></p> <p><i>Berlingo 1.4 l</i> <i>Saxo 1.4 l</i> <i>Xsara 1.4 l</i> <i>106 II 1.4 l</i> <i>205 II 1.4 l</i> <i>206 1.4 l</i> <i>306 1.4 l</i> <i>307 1.4 l</i> <i>Partner 1.4 l</i></p> 	<p>18-7510060 STD -mm 18-7510063 0,50 mm</p>	<p>A = 27,750 B = 49,930 D = 0,180</p>	<p>RE47580000 -STD RE47580050 -0,50</p> <p>1,500 (500) CrB Fe S IF 1,500 (501) P 2,500 (700) Cr P S</p>	<p>ø18,0 x 55,0</p>	<p>G79501350S_1</p> <p>A= 79,500 B= 75,000 D= 89,200 F= 0,000 H= 90,000 L= 135,000</p> 		
<p>ø75,00</p> <p>4. Cyl. Gasoline 1361cc 54/55 kW 73/75 ps TU3JP <u>2005 -....</u></p> <p><i>PARTNER 1.4i</i> <i>1007 1.4i</i> <i>307 1.4i</i> <i>306 1.4i</i> <i>206 1.4i</i> <i>RANCH 1.4i</i> <i>106 1.4i</i></p>	<p>18-7510090 STD -mm</p>	<p>A = 27,900 B = 49,700 C = 1,250 CD= 64,750</p>	<p>RE47580000 -STD RE47580050 -0,50</p> <p>1,500 (500) CrB Fe S IF 1,500 (501) P 2,500 (700) Cr P S</p>	<p>ø18,0 x 55,0</p>			

Engine	Ref. No. - Kit 1	Dimensions	Rings	Pin	Piston Liner	Kit 2	Info
<p>ø75,00</p> <p>R 4 Petrol, 1218 cm³ 42 kW (57 hp) XZ5 XY6B XY7 XYB XYR <u>1978 - 1984</u></p>	<p>14-7510100 STD -mm</p>	<p>A = 28,250 B = 52,330 D = 1,300 E = -3,100</p>	<p>RE47000000 -STD RE47000050 -0,50</p> <p>1,750 (500) CrBSIF 2,000 (508) P 3,000 (700) CrPS</p>	<p>ø19,5 x 62,0</p>			
<p>ø75,00</p> <p>R 4 Petrol, 1361 cm³ 65 kW (88 hp) KFU(ET 3 J4) <u>2003 -....</u> C 2 1.4 I C 3 1.4 I C 4 1.4 I 1007 1.4 I 206 1.4 207 1.4 307 1.4</p>	<p>18-7510110 STD -mm 18-7510113 0,50 mm</p>	<p>A = 28,250 B = 52,330 D = 1,300 E = -3,180</p>	<p>RE47590000 -STD RE47590050 -0,50</p> <p>1,200 (500) Cr P 1,500 (508) P 2,500 (604) P</p>	<p>ø18,0 x 44,5</p>	<p>G79501350S_1</p> <p>A= 79,500 B= 75,000 D= 89,200 F= 0,000 H= 90,000 L= 135,000</p>		

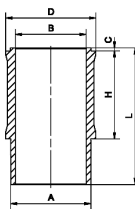
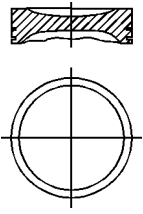
Engine	Ref. No. - Kit 1	Dimensions	Rings	Pin	Piston Liner	Kit 2	Info
<p>ø75,00</p> <p>R 4 Petrol, 1361 cm³ 55 kW (75 hp), 10,5:1 TU3JPL4 KFW(TU3JP) KFX(TU3JP) <u>2004 -....</u></p> <p><i>Berlingo 1.4 l</i> <i>Saxo 1.4 l</i> <i>Xsara 1.4 l</i> <i>106 II 1.4 l</i> <i>205 II 1.4 l</i> <i>206 1.4 l</i> <i>306 1.4 l</i> <i>307 1.4 l</i> <i>Partner 1.4 l</i></p> 	<p>18-7510120 STD -mm 18-7510123 0,50 mm</p>	<p>A = 27,750 B = 49,930 D = 0,180</p>	<p>RE47580000 -STD RE47580050 -0,50</p> <p>1,500 (500) CrB Fe S IF 1,500 (501) P 2,500 (700) Cr P S</p>	<p>ø18,0 x 55,0</p>	<p>G79501350S_1</p> <p>A= 79,500 B= 75,000 D= 89,200 F= 0,000 H= 90,000 L= 135,000</p> 		
<p>ø75,00</p> <p>R 4 Petrol, 1361 cm³ 44 55 kW (60 75 hp) 9,3:1 TU3A <u>1987-1992</u></p> <p><i>106</i> <i>205</i> <i>206</i> <i>306</i> <i>309</i> <i>Partner</i></p> 	<p>14-7510270 STD -mm 14-7510273 0,50 mm</p>	<p>A = 40,500 B = 64,500 C = 1,100 CD= 63,000</p>	<p>RE47000000 -STD RE47000050 -0,50</p> <p>1,750 (500) CrBSIF 2,000 (508) P 3,000 (700) CrPS</p>	<p>ø19,5 x 62,0</p>			

Engine	Ref. No. - Kit 1	Dimensions	Rings	Pin	Piston Liner	Kit 2	Info
<p>ø75,00</p> <p>3 SiL.Gasoline.1199cc 53kW (72ps) 1.2 VTi (72 Hp) Euro 5 EB2 M 301 1.2 16V <u>2012 -....</u> <i>C-Elysee 1.2 VTi 301 1.2 VTi</i></p>	<p>18-7511270 STD -mm 18-7511273 0,50 mm</p>	<p>A = 28,810 B = 46,820 C = 8,000 E = -1,200 CD= 64,500</p> <p>Hard Anodising</p>	<p>RE18520000 -STD RE18520050 -0,50</p> <p>1,000 (910) NIT SY 1,000 (931) FE S 2,000 (947) EX NIT S</p>	<p>ø17,0 x 51,0</p>			
<p>ø75,00</p> <p>3 SiL.Gasoline.1199cc 60kW (82ps) 1.2 VTi (72 Hp) Euro 5 EB2 108/2008/208/308II 1.2 60KW/82 PS <u>2012 -....</u> <i>108 2008 208308 II 1.2 VTi 60 kW/82 PS</i></p>	<p>18-7511280 STD -mm 18-7511283 0,50 mm</p>	<p>A = 26,500 B = 45,000 C = 5,300</p> <p>Hard Anodising</p>	<p>RE18520000 -STD RE18520050 -0,50</p> <p>1,000 (910) NIT SY 1,000 (931) FE S 2,000 (947) EX NIT S</p>	<p>ø17,0 x 51,0</p>			







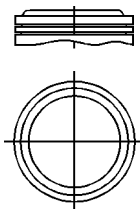
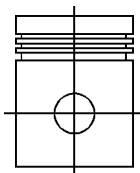

Engine	Ref. No. - Kit 1	Dimensions	Rings	Pin	Piston Liner	Kit 2	Info
<p>ø77,00</p> <p>4 Cyl.Gasoline 1598 cc BMW N 13 B16A MINI N18 B 16A 2010 -....</p> <p><i>BMW 116i MINI COOPER S 1.6i 16V PEUGEOT 77 MM</i></p>	<p>18-5510310 STD -mm 18-5510310-30 STD -mm 18-5510313 0,50 mm 18-5510313-30 0,50 mm</p>	<p>A = 28,500 B = 51,200 C = 3,500 D = 2,700 E = -3,300 F = -3,400 CD= 34,700</p> <p>Hard Anodising</p>	<p>RE15260000 -STD ø20,0 RE15260000_NPR -STD ø18,0 RE15260050 -0,50 RE15260050_NPR -0,50</p> <p>1,200 (500) Cr S IF 1,500 (508) P 2,000 (700) Cr P S</p>				
<p>ø77,00</p> <p>4 Cyl.Gasoline 1598 cc EP6 EP6C 2010 -....</p> <p><i>3008 16i 16V 5008 1.6i 2 207 1.6 16V 308 1.6 16V</i></p>	<p>18-5510320 STD -mm 18-5510323 0,50 mm</p>	<p>A = 27,500 B = 47,500 C = 2,000 E = -5,700 F = -3,800 CD= 56,600</p>	<p>RE15260000 -STD ø18,0 RE15260000_NPR -STD ø13,0 RE15260050 -0,50 RE15260050_NPR -0,50</p> <p>1,200 (500) Cr S IF 1,500 (508) P 2,000 (700) Cr P S</p>				

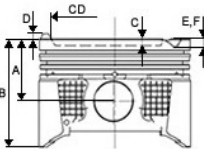

Engine	Ref. No. - Kit 1	Dimensions	Rings	Pin	Piston Liner	Kit 2	Info
<p>ø77,00</p> <p>4 Cyl. Gasoline 13970 cc 70 kW 95 PS EP3</p> <p>..... -</p> <p>207 WA/WC 1.4 16V 207 SW (WK) 1.4 16V 308 4A/4C 1.4 16V</p>	<p>18-7510280 STD -mm 18-7510283 0,50 mm</p>	<p>A = 27,600 B = 47,500 D = 3,100</p>	<p>RE15260000 -STD ø18,0 RE15260000_NPR -STD ø13,0 RE15260050 -0,50 RE15260050_NPR -0,50</p> <p>1,200 (500) Cr S IF 1,500 (508) P 2,000 (700) Cr P S</p>				
<p>ø77,00</p> <p>4 Cyl. Diesel 1527cc 37 42 Kw (50 57 Ps) VJX VJY VJZ (TUD5) TUD 5</p> <p>1994 -.....</p> <p>106 II Micra 1.5D Saxo 1.5D XSara 1.5D 106 1.5D 2 Serisi</p>	<p>18-7550420 STD -mm 18-7550422 0,40 mm</p>	<p>A = 40,400 B = 66,300 C = 1,580 E = -2,040</p> <p>Oil Cut-Out</p>	<p>RE47270000 -STD ø23,0 RE47270040 -0,40 x 60,0</p> <p>2,000 (500) Cr P 1,750 (501) P 3,000 (604) Cr P</p>				<p>+1,04 +1,14</p>

Engine	Ref. No. - Kit 1	Dimensions	Rings	Pin	Piston Liner	Kit 2	Info
<p>ø78,00</p> <p>R 4 Petrol, 1290 cm³ 44 48 kW (60 65 hp) XL5 <u>1976-1988</u> 305 SR</p>	<p>14-7510140 STD -mm 14-7510143 0,50 mm</p>	<p>A = 36,100 B = 72,300</p>	<p>RE47400000 -STD RE47400050 -0,50</p> <p>1,750 (500) CrB S IF 2,000 (501) P 4,000 (604) P</p>	<p>ø20,5 x 68,0</p>			
<p>ø78,00</p> <p>R 4 Petrol, 1472 cm³ 49 58 kW (67 79 hp) XR5 <u>1977-.....</u> 305 SR</p>	<p>14-7510150 STD -mm 14-7510153 0,50 mm</p>	<p>A = 36,100 B = 73,100 D = 0,400</p>	<p>RE47400000 -STD RE47400050 -0,50</p> <p>1,750 (500) CrB S IF 2,000 (501) P 4,000 (604) P</p>	<p>ø20,5 x 68,0</p>			



							
Engine	Ref. No. - Kit 1	Dimensions	Rings	Pin	Piston Liner	Kit 2	Info
<p>ø78,50</p> <p>4 Cyl. Gasoline 1587 cc 80 Kw (109 Ps) TU5JP4 Euro3 <u>2000 -....</u></p> <p>C3 1.6i 16V Berlingo 1.6i 16v 206 1.6i 16v 207 1.6i 16v 307 1.6i 16v Partner 1.6i 16v</p>	<p>18-7510700 STD -mm 18-7510703 0,50 mm</p>	<p>A = 32,350 B = 50,150 D = 0,150</p> <p>Oil Cut-Out</p>	<p>RE47380000 -STD RE47380025 -0,25 RE47380040 -0,40 RE47380050 -0,50 RE47380100 -1,00</p> <p>1,200 (500) MoB N S 1,500 (508) P 2,500 (604) P</p>	<p>ø19,6 x 57,0</p>			
<p>ø78,50</p> <p>4 Cyl. Gasoline 1587 cc 80 Kw (118 Ps) 10,8:1 16 Ventile NFX (TU5J4) <u>05/1996 -....</u></p> <p>106 GTI 106 II 1.6 206 306 307</p>	<p>18-7510710 STD -mm 18-7510711 0,25 mm 18-7510713 0,50 mm</p>	<p>A = 32,500 B = 57,800 C = 1,200</p>	<p>RE47280000 -STD RE47280025 -0,25 RE47280050 -0,50</p> <p>1,500 (500) Cr P S IF 1,500 (508) P 3,000 (700) Cr P S</p>	<p>ø19,5 x 59,0</p>			



Engine	Ref. No. - Kit 1	Dimensions	Rings	Pin	Piston Liner	Kit 2	Info
<p>ø78,50</p> <p>4 Cyl. Gasoline 85 kw 115 HP EC5 1.6 VTI EURO 5 <u>2012 -</u> 301 C-ELYSEE</p>	<p>18-7510820 STD -mm 18-7510823 0,50 mm</p>	<p>A = 32,350 B = 53,750 D = 1,400 E = -2,450</p>	<p>RE47650000 -STD RE47650050 -0,50</p> <p>1,000 (500) Nit S IF 1,200 (508) P 2,000 (604) Nit S</p>	<p>ø19,6 x 57,0</p>			
<p>ø78,50</p> <p>R 4 Petrol, 1587 cm³ 65 kW (88 hp) TU5JP <u>1996 - 1998</u> C3 1.6i 16V Berlingo 1.6i 16v 206 1.6i 16v 307 1.6i 16v Partner 1.6i 16v</p>	<p>18-7510880 STD -mm 18-7510882 0,40 mm 18-7510883 0,50 mm</p>	<p>A = 32,250 B = 57,500 C = 1,500 CD= 68,500</p>	<p>RE47280000 -STD RE47280025 -0,25 RE47280050 -0,50</p> <p>1,500 (500) Cr P S IF 1,500 (508) P 3,000 (700) Cr P S</p>	<p>ø19,5 x 61,9</p>			

Engine	Ref. No. - Kit 1	Dimensions	Rings	Pin	Piston Liner	Kit 2	Info
<p>ø78,60</p> <p>4 Cyl. Gasoline 87 kw 114 Ps EF7 <u>2008 -</u></p> <p><i>IKCO Dena SAMAND SOREN</i></p>	<p>18-7510810 STD -mm 18-7510811 0,25 mm 18-7510813 0,50 mm</p>	<p>A = 29,700 B = 51,700 C = 3,550</p>	<p>RE47620000 -STD RE47620025 -0,25 RE47620050 -0,50</p> <p>1,200 (500) CrB Fe S 1,500 (508) P 2,500 (700) P S</p>	<p>ø21,0 x 58,0</p>			
<p>ø80,00</p> <p>4 Cyl. Diesel 1768 cc 22:1 Turbo XUD7T TE TEY <u>1995 -</u></p> <p><i>205 TD 309TD SRD GRD SXD XSD,405TD SRD GRD GTD</i></p>	<p>18-7550430 STD -mm 18-7550433 0,50 mm 18-7550437 0,80 mm</p>	<p>A = 46,800 B = 84,500 C = 2,200</p> <p>Ring Carrier Hard Anodising Oil Cut-Out</p>	<p>RE47050000 -STD RE47050050 -0,50 RE47050080 -0,80</p> <p>3,000 (504) Cr 2,000 (501) P 3,000 (604) Cr P</p>	<p>ø28,0 x 68,0</p>			<p>1. Tamir + 0,54 + 0,65</p> <p>2. Tamir + 0,65 + 0,77</p> <p>3. Tamir + 0,77 + 0,82</p>

Engine	Ref. No. - Kit 1	Dimensions	Rings	Pin	Piston Liner	Kit 2	Info
<p>ø80,00</p> <p>R 4 Diesel, 1769 cm³ 44 kW (60 PS) 23:1 8 Ventile XUD7</p> <p><u>1985 - 1993</u></p> <p>205 I 1.7 D 205 II 1.7 D 305 II 1.8 D 306 1.8 D BIPPER 1.8 D</p>	<p>18-7550440 STD -mm 18-7550443 0,50 mm 18-7550447 0,80 mm</p>	<p>A = 46,800 B = 84,500 C = 2,000</p>	<p>RE47060000 -STD RE47060050 -0,50 RE47060080 -0,80 RE47060100 -1,00</p> <p>2,000 (500) CrB S 2,000 (501) P 3,000 (604) Cr P</p>	<p>ø25,0 x 69,8</p>			
<p>ø81,00</p> <p>4/6 Cyl. Diesel 2720cc 150 KW(204 PS) 2.7 Lion TVM 276DT PEUGEOT JAGUAR</p> <p><u>2008 -....</u></p> <p>DISCOVERY 2.7 TDI RANGE ROVER 2.7 TDV6 2008 -</p>	<p>18-6592100 STD -mm 18-6592103 0,50 mm</p>	<p>A = 47,000 B = 71,000 C = 14,050 E = -0,500 F = -0,500 CD= 44,000</p> <p>Ring Carrier Oil Gallery</p>	<p>RE47570000 -STD RE47570050 -0,50</p> <p>2,000 (500) Cr PIF 2,000 (501) P IFU 2,000 (604) Nit S</p>	<p>ø29,0 x 62,0</p>			

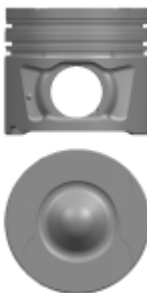

Engine	Ref. No. - Kit 1	Dimensions	Rings	Pin	Piston Liner	Kit 2	Info
<p>ø82,20</p> <p>4 Cyl. Diesel 1868 cc 51 Kw (71 Ps) 23:1 DW8 <u>1998 -....</u> 206 1.9 D 306 1.9 D Expert 1.9 D Partner 1.9 D</p>	<p>18-7550460 STD -mm 18-7550460-20 STD -mm (0.2 mm SHORT)</p> <p>18-7550463 0,50 mm 18-7550463-20 0,50 mm (0.2 mm SHORT)</p> <p>18-7550464 0,60 mm 18-7550464-20 0,60 mm (0.2 mm SHORT)</p> <p>18-7550467 0,80 mm 18-7550468 1,00 mm</p>	<p>A = 46,730 B = 78,000 C = 1,300</p> <p>Oil Cut-Out</p>	<p>RE47430000 -STD RE47430050 -0,50 RE47430060 -0,60 RE47430080 -0,80 RE47430100 -1,00</p> <p>2,000 (500) CrBS 2,000 (508) P 3,000 (604) Cr</p>	<p>ø25,0 x 66,0</p>			<p>1.26 mm Gasket + 0,51 + 0,55</p> <p>1.30 mm Gasket + 0,55 + 0,59</p> <p>1.34 mm Gasket + 0,59 + 0,63</p>
<p>ø83,00</p> <p>4 Cyl. Gasoline 1580 cc 9,5:1 XU5 S 2C 1C CP <u>1982 - 1990</u> 205 Automatic Open XR XS XT 305GL</p>	<p>18-7510180 STD -mm 18-7510183 0,50 mm</p>	<p>A = 37,500 B = 67,500 C = 2,100</p>	<p>RE47080000 -STD RE47080050 -0,50 RE47080080 -0,80</p> <p>1,750 (500) CrB S IF 1,750 (508) P 4,000 (700) Cr P S</p>	<p>ø22,0 x 66,0</p>	<p>G88001410S_1</p> <p>A= 79,500 B= 75,000 D= 89,200 F= 0,000 H= 90,000 L= 135,000</p>		

Engine	Ref. No. - Kit 1	Dimensions	Rings	Pin	Piston Liner	Kit 2	Info
<p>ø83,00</p> <p>R 4 Petrol, 1580 cm³ 59 66 kW (80 90 hp) XU52C CR <u>1982 - 1990</u></p> <p>309 405 1983></p>	<p>14-7510190 STD -mm</p>	<p>A = 37,500 B = 67,500 C = 2,900</p>	<p>RE47080000 -STD RE47080050 -0,50 RE47080080 -0,80</p> <p>1,750 (500) CrB S IF 1,750 (508) P 4,000 (700) Cr P S</p>	<p>ø22,0 x 66,2</p>			
<p>ø83,00</p> <p>R 4 Petrol, 1905 cm³ 73 95 kW (99 129 hp) XU9JA <u>1985 - 1993</u></p> <p>205 1,9 GTI 309 1,9</p>	<p>14-7510360 STD -mm 14-7510363 0,50 mm</p>	<p>A = 37,500 B = 67,500 C = 9,000</p>	<p>RE47090000 -STD RE47090050 -0,50</p> <p>1,500 (500) CrB S IF 1,500 (501) P 4,000 (700) Cr S</p>	<p>ø22,0 x 66,2</p>			

Engine	Ref. No. - Kit 1	Dimensions	Rings	Pin	Piston Liner	Kit 2	Info
<p>ø83,00</p> <p>R 4 Petrol, 1581 cm³ 53 59 kW (72 80 hp) XU51C XU92C</p> <p><u>1982 - 1990</u></p> <p>309 405</p>	<p>14-7510380 STD -mm 14-7510383 0,50 mm</p>	<p>A = 37,500 B = 67,500 C = 3,000 CD= 73,800</p>	<p>RE47080000 -STD RE47080050 -0,50 RE47080080 -0,80</p> <p>1,750 (500) CrB S IF 1,750 (508) P 4,000 (700) Cr P S</p>	<p>ø22,0 x 66,2</p>			
<p>ø83,00</p> <p>4 Cyl. Gasoline 1762 cc 74 76 KW101 103PS 9,25;1 XU7JPZ</p> <p><u>1992 - 2002</u></p> <p>306 1,8i 405 1,8i 806 1,8i</p>	<p>18-7510400 STD -mm 18-7510403 0,50 mm</p>	<p>A = 33,300 B = 53,300 C = 4,200 CD= 67,700</p> <p>Steel Support</p>	<p>RE47100000 -STD RE47100050 -0,50 RE47100080 -0,80</p> <p>1,500 (500) CrB Fe S IF 1,500 (501) P 3,000 (700) Cr P S</p>	<p>ø22,0 x 62,0</p>	<p>G88001410S_1</p> <p>A= 79,500 B= 75,000 D= 89,200 F= 0,000 H= 90,000 L= 135,000</p>		

Engine	Ref. No. - Kit 1	Dimensions	Rings	Pin	Piston Liner	Kit 2	Info
<p>ø83,00</p> <p>R 4 Diesel, 1905 cm³ 55 69 kW (75 94 PS) XUD9/A <u>1995 -</u></p> <p>205 II 1.9D 306 1.9D 309 II 1.9D 405 II 1.9D Boxer 1.9D Partner 1.9D</p> 	<p>18-7550450 STD -mm 18-7550453 0,50 mm 18-7550458 1,00 mm</p>	<p>A = 46,800 B = 84,300 C = 2,200</p>	<p>RE47070000 -STD RE47070050 -0,50 RE47070060 -0,60 RE47070080 -0,80 RE47070100 -1,00</p> <p>2,000 (500) CrB S 2,000 (501) P 3,000 (604) Cr P</p>	<p>ø25,0 x 72,0</p>			
<p>ø83,00</p> <p>4 Cyl. Diesel 1905 cc 51 Kw (69 Ps) 23,5:1 XUD9/A/L/Y <u>1996 -.....</u></p> <p>205D GLD GRD/XLD/XRD 305D/GLD/GRD/SRD Utilitaire 306/309D GLD/GRD/GTD/SRD XDT/XRD/X 405GLD/GRD/J5 Boxer Expert Partner</p>	<p>18-7550480 STD -mm 18-7550483 0,50 mm 18-7550488 1,00 mm</p>	<p>A = 46,850 B = 84,250 C = 2,200</p> <p>Ring Carrier</p>	<p>RE47070000 -STD RE47070050 -0,50 RE47070060 -0,60 RE47070080 -0,80 RE47070100 -1,00</p> <p>2,000 (500) CrB S 2,000 (501) P 3,000 (604) Cr P</p>	<p>ø25,0 x 70,4</p>			

Engine	Ref. No. - Kit 1	Dimensions	Rings	Pin	Piston Liner	Kit 2	Info
<p>ø83,00</p> <p>4 Cyl. Gasoline 1905 cc 9,3:1 8v MPi XU9JA J1 J2 JAZ M <u>1986 - 1998</u></p> <p><u>19 Evasion</u> XU9J1 (D6A) XUPJ2 (DFZ) 19 RI XU9J1 (D6A) XUPJ2 (DFZ) 19 RI XU9JA (DDZ-DKZ) 19 TRI XU9JA (DDZ-DKZ) 19GTI XU9J1 (D6A) XUPJ2 (DFZ) 19GTI XU9JA (DDZ-DKZ) 19TRI XU9J1 (D6A) XUPJ2 (DFZ) BX 19 4W</p>	<p>14-7550490 STD -mm</p>	<p>A = 37,500 B = 67,500 C = 8,900</p> <p>Steel Support</p>	<p>RE47090000 -STD RE47090050 -0,50</p> <p>1,500 (500) CrB S IF 1,500 (501) P 4,000 (700) Cr S</p>	<p>ø22,0 x 66,2</p>			
<p>ø85,00</p> <p>4 Cyl. Diesel 1997/1998 cc 79/80/81/100Kw 90/107/109Ps 110/136 Ps DW10ATED TD10ATED DW10TD Euro 3 G6DB RHS RHW RHX RHY RHZ D420 4T</p> <p><u>1998 -</u></p> <p>2.0 HDI 206/306/307/406 Boxer Partner Expet C5 Jumpy Xsara Scudo 2.0JTD Cmax Focus II Grand Vitara C30 C70 S40/80 II V50 V70 III TDI</p>	<p>18-7550900 STD -mm 18-7550900-20 STD -mm (0.2 mm SHORT) 18-7550903 0,50 mm 18-7550904 0,60 mm</p>	<p>A = 46,750 B = 80,750 C = 18,300 E = -1,000 CD= 38,000</p> <p>Ring Carrier Oil Cut-Out</p>	<p>RE47440000 -STD RE47440060 -0,60</p> <p>3,500 (505) Cr P 2,000 (501) P IFU 3,000 (604) Cr P</p>	<p>ø28,0 x 70,0</p>			<p>1,25 mm Gasket +0,55 + 0,60</p> <p>1,30 mm Gasket +0,61 +0,65</p> <p>1,35 mm Gasket +0,66 +0,70</p> <p>1,40 mm Gasket +0,71 +0,75</p>

Engine	Ref. No. - Kit 1	Dimensions	Rings	Pin	Piston Liner	Kit 2	Info
<p>ø83,00</p> <p>R 4 Diesel, 1905 cm³ 55 69 kW (75 94 PS) XUD9ATF XUD9BSD XUD9BTF</p> <p><u>1993 - 2004</u></p> <p>306 1.9 TD 405 1.9 TD 406 1.9 TD 806 1.9 TD Boxer 1.9 TD Ducato 1.9 TD</p>	<p>18-7550910 STD -mm 18-7550913 0,50 mm 18-7550917 0,80 mm</p>	<p>A = 46,750 B = 79,250 C = 3,500</p> <p>Hard Anodising</p>	<p>RE22250000 -STD RE22250050 -0,50 RE22250080 -0,80</p> <p>3,000 (504) Cr P 2,000 (501) P 3,000 (604) Cr P</p>	<p>ø28,0 x 68,0</p>			
<p>ø83,00</p> <p>R 4 Diesel, 1905 cm³ 55 69 kW (75 94 PS) XUD9ATF XUD9BSD XUD9 BTF</p> <p><u>1992 - 2004</u></p> <p>306 1.9 TD 405 1.9 TD 406 1.9 TD 806 1.9 TD Boxer 1.9 TD Ducato 1.9 TD</p>	<p>14-7550920 STD -mm 14-7550923 0,50 mm</p>	<p>A = 46,750 B = 79,250 C = 3,500</p> <p>Ring Carrier Hard Anodising Oil Cut-Out</p>	<p>RE47230000 -STD RE47230050 -0,50 RE47230080 -0,80</p> <p>3,500 (504) Cr 2,000 (501) P 3,000 (604) Cr P</p>	<p>ø28,0 x 68,0</p>			

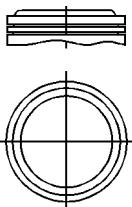

Engine	Ref. No. - Kit 1	Dimensions	Rings	Pin	Piston Liner	Kit 2	Info
<p>ø85,00</p> <p>R 4 Diesel, 1997 cm³ 62 88 kW (84 120 PS) DW10BTED4 <u>1999 - 2007</u></p> <p>(2.0HDI) Berlingo C4 16V C4 GrandPicasso 16V C4 Picasso 16V C5 16V C8 16V Jumpy 6V C-Max Kuga 307 16V 307 CC 16V 308 16V 407 16V 508</p>	<p>18-7551920 STD -mm 18-7551924 0,60 mm</p>	<p>A = 46,705 B = 80,705 C = 15,400 E = -0,520 CD= 44,800</p> <p>Ring Carrier Oil Gallery Oil Cut-Out</p>	<p>RE47440000 -STD RE47440060 -0,60</p> <p>3,500 (505) Cr P 2,000 (501) P IFU 3,000 (604) Cr P</p>	<p>ø28,0 x 70,0</p>			
<p>ø84,00</p> <p>R 4 Gasoline1796cc 49 51kW(69 PS) 7,5:1,8 VentileC25 1.8 169 (XM7T) <u>07/87-02/94</u></p> <p>C25 1.8 E C25 1.8E7/87-2/94 DUCATO 1.8 1/82-10/88 504 1.8 1/71-12/89 505 1.8 6/81-10/85 J5 1.8 1/83-11/88 7/70-3/80</p>	<p>14-7510020 STD -mm</p>	<p>A = 37,800 B = 70,250</p>	<p>RE22280000 -STD</p> <p>1,500 (500) Cr S IF 2,000 (508) P 4,000 (700) Cr P S</p>	<p>ø23,0 x 70,0</p>			

Engine	Ref. No. - Kit 1	Dimensions	Rings	Pin	Piston Liner	Kit 2	Info
<p>ø84,00</p> <p>R 4 Petrol, 1796 cm³ 48 58 kW (65 79 hp) 7,5:1 XM7 KF5 KF6 <u>1971 - 1981</u></p> <p>504 505 J7 J9 1986></p>	<p>14-7510030 STD -mm</p>	<p>A = 37,300 B = 70,300 D = 1,000</p>	<p>RE47120000 -STD</p> <p>1,500 (500) CrS IF 25,000 (508) P 4,000 (700) Cr P S</p>	<p>ø23,0 x 70,0</p>			
<p>ø85,00</p> <p>4 Cyl. Diesel 2179 cc 110 KW 150 HP DW12BTED4 PEUGEOT COMMON ENGINE <u>2010 -....</u></p> <p>Freelander 2 2.2 TD4 2010</p>	<p>14-6592990 STD -mm 14-6592993 0,50 mm</p>	<p>A = 48,705 B = 74,705 C = 13,475 E = -0,385 CD= 52,400</p> <p>Ring Carrier Oil Gallery Oil Cut-Out</p>	<p>RE35000000 -STD RE35000050 -0,50</p> <p>2,500 (505) Cr P 2,000 (501) P IFU 2,000 (604) Nit S</p>	<p>ø30,0 x 68,0</p>			

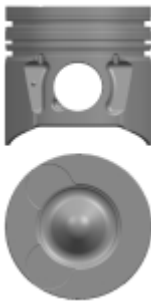

Engine	Ref. No. - Kit 1	Dimensions	Rings	Pin	Piston Liner	Kit 2	Info
<p>ø85,00</p> <p>4 Cyl. Gasoline 2000 cc 100/105 kW 136/1436 PS EW10J B</p> <p>..... -</p> <p>307 206 EXPEERT 407 607 406 806</p>	<p>18-7510750 STD -mm 18-7510752 0,40 mm 18-7510754 0,60 mm</p>	<p>A = 29,000 B = 51,000 C = 0,750 CD= 48,000</p>	<p>RE18500000 -STD RE18500040 -0,40 RE18500050 -0,50 RE18500060 -0,60 RE18500080 -0,80</p> <p>1,200 (500) Nit S IF 1,500 (508) P 2,500 (700) Nit S</p>	<p>ø21,0 x 68,0</p>			
<p>ø85,00</p> <p>4 Cyl. Diesel 2088 cc 81 Kw (110 Ps) 21,5:1 XUD11BTE</p> <p>1995 -.....</p> <p>406 2.1TD 605 2.1TD 806 2.1TD</p>	<p>14-7550880 STD -mm 14-7550884 0,60 mm</p>	<p>A = 44,900 B = 74,700 C = 2,400</p> <p>Ring Carrier Hard Anodising Oil Gallery Oil Cut-Out</p>	<p>RE47240000 -STD RE47240050 -0,50 RE47240060 -0,60</p> <p>3,000 (504) Cr P 2,000 (501) P 3,000 (604) Cr P</p>	<p>ø30,0 x 68,0</p>			<p>1.52 mm Gasket 0,65 0,75</p> <p>1.57 mm Gasket 0,77 0,81</p> <p>1.62 mm Gasket 0,82 0,86</p>

Engine	Ref. No. - Kit 1	Dimensions	Rings	Pin	Piston Liner	Kit 2	Info
<p>ø85,00</p> <p>Turbo Intercooler 3 Valf DW12TD/TED <u>2002 -....</u></p> <p>607 HDI 406 HDI Boxer 330M/330C/290C 2,2 HDI</p>	<p>18-7550890 STD -mm 18-7550894 0,60 mm</p>	<p>A = 48,700 B = 70,700 C = 17,700 E = -1,200 CD= 42,000</p> <p>Ring Carrier Oil Cut-Out</p>	<p>RE47440000 -STD RE47440060 -0,60</p> <p>3,500 (505) Cr P 2,000 (501) P IFU 3,000 (604) Cr P</p>	<p>ø30,0 x 68,0</p>			
<p>ø85,00</p> <p>4 Cyl. Diesel 1997/1998 cc 79/80/81/100Kw 90/107/109Ps 110/136 Ps DW10ATED TD10ATED DW10TD Euro 3 G6DB RHS RHW RHX RHY RHZ D420 4T</p> <p><u>1998 -</u></p> <p>2,0 HDI 206/306/307/406 Boxer Partner Expet C5 Jumpy Xsara Scudo 2.0JTD Cmax Focus II Grand Vitara C30 C70 S40/80 II V50 V70 III TDI</p>	<p>18-7550900 STD -mm 18-7550900-20 STD -mm (0.2 mm SHORT) 18-7550903 0,50 mm 18-7550904 0,60 mm</p>	<p>A = 46,750 B = 80,750 C = 18,300 E = -1,000 CD= 38,000</p> <p>Ring Carrier Oil Cut-Out</p>	<p>RE47440000 -STD RE47440060 -0,60</p> <p>3,500 (505) Cr P 2,000 (501) P IFU 3,000 (604) Cr P</p>	<p>ø28,0 x 70,0</p>			<p>1,25 mm Gasket +0,55 + 0,60</p> <p>1,30 mm Gasket +0,61 +0,65</p> <p>1,35 mm Gasket +0,66 +0,70</p> <p>1,40 mm Gasket +0,71 +0,75</p>

Engine	Ref. No. - Kit 1	Dimensions	Rings	Pin	Piston Liner	Kit 2	Info
<p>ø85,00</p> <p>R 4 Diesel, 1997 cm³ 62 88 kW (84 120 PS) DW10BTED4 <u>1999 - 2007</u></p> <p>(2.0HDI) Berlingo C4 16V C4 GrandPicasso 16V C4 Picasso 16V C5 16V C8 16V Jumpy 6V C-Max Kuga 307 16V 307 CC 16V 308 16V 407 16V 508</p> 	<p>18-7551920 STD -mm 18-7551924 0,60 mm</p>	<p>A = 46,705 B = 80,705 C = 15,400 E = -0,520 CD= 44,800</p> <p>Ring Carrier Oil Gallery Oil Cut-Out</p>	<p>RE47440000 -STD RE47440060 -0,60</p> <p>3,500 (505) Cr P 2,000 (501) P IFU 3,000 (604) Cr P</p>	<p>ø28,0 x 70,0</p>			
<p>ø85,00</p> <p>4 Cyl. Diesel 1997 cc 163PS DW10CTED4 <u>2009 -</u></p> <p>3008 5008 C4 C5 III 2.0 HDI DS4 KUGA</p> 	<p>18-7592960 STD -mm 18-7592964 0,50 mm</p>	<p>A = 46,705 B = 74,705 C = 13,710 E = -0,455 CD= 50,400</p> <p>Ring Carrier Oil Gallery Oil Cut-Out</p>	<p>RE47770000 -STD RE47770060 -0,60</p> <p>2,000 () 2,000 () P 2,000 ()</p>	<p>ø30,0 x 68,0</p>			

Engine	Ref. No. - Kit 1	Dimensions	Rings	Pin	Piston Liner	Kit 2	Info
<p>ø86,00</p> <p>4 Cyl. Gasoline 1998 cc 88 Kw (121 Ps) XU10J2 XU10J2 TE XU 10J2 Z</p> <p><u>1993 -....</u></p> <p>Dizel 2446 cc Boxer 2,5 D 1996</p>	<p>18-7510860 STD -mm 18-7510863 0,50 mm 18-7510864 0,60 mm</p>	<p>A = 40,000 B = 64,850 C = 5,000</p>	<p>RE47130000 -STD RE47130025 -0,25 RE47130050 -0,50 RE47130060 -0,60</p> <p>1,500 (500) CrB S 1,750 (508) P 3,000 (700) Cr P S</p>	<p>ø22,0 x 62,0</p>			
<p>ø86,00</p> <p>R 4 Petrol, 1998 cm³ 98 kW (133 hp) XU10J4R</p> <p><u>1995 -....</u></p> <p>206 306 307 406 Boxer Partner</p>	<p>18-7510870 STD -mm 18-7510873 0,50 mm 18-7510874 0,60 mm</p>	<p>A = 33,800 B = 53,800 C = 4,300 E = -1,700 F = -2,000 CD= 52,000</p> <p>Oil Cut-Out</p>	<p>RE47130000 -STD RE47130025 -0,25 RE47130050 -0,50 RE47130060 -0,60</p> <p>1,500 (500) CrB S 1,750 (508) P 3,000 (700) Cr P S</p>	<p>ø22,0 x 62,0</p>			

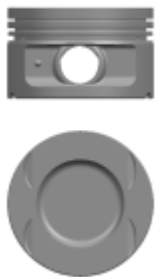
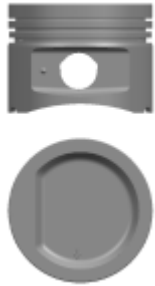



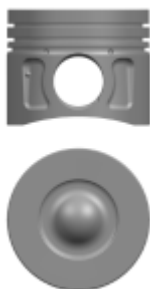



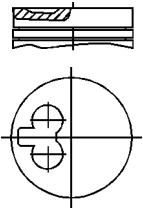
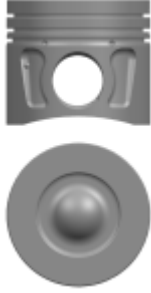

Engine	Ref. No. - Kit 1	Dimensions	Rings	Pin	Piston Liner	Kit 2	Info
<p>ø86,00</p> <p>4 Petrol, 1998 cm³ 120 kW (163 PS) 10:1 16 Ventile RFS (XU10J4RS) <u>05/1996 - 03/2005</u></p> <p><i>XSARA 2.0 I</i> <i>ZSARA 2.0 16 ZX 2.0 I</i></p>	<p>18-7510900 STD -mm 18-7510904 0,60 mm</p>	<p>A = 33,900 B = 58,400 C = 2,000 E = -1,740 F = -1,350 CD= 71,920</p> <p>Oil Cut-Out</p>	<p>RE43190000 -STD RE43190050 -0,50 RE43190100 -1,00</p> <p>1,500 (500) CrB S 1,500 (501) P 3,000 (700) Cr P S</p>	<p>ø22,0 x 62,0</p>			
<p>ø86,01</p> <p>4 Cyl. Diesel 2198 cc 100/120/130 Ps 17,5:1 QWFB/V347 Duratorq Euro 4 Duratorq/V347 D <u>2003/2008..</u></p> <p><i>Common Rail</i> <i>Transit 2.2 TDCI</i> <i>Yeni Jumper 2.2 HDI</i> <i>Ducato 100 Multijet</i> <i>Yeni Boxer HDI</i></p>	<p>18-2582350 STD -mm 18-2582350-20 STD -mm (0.2 mm SHORT) 18-2582351 0,25 mm 18-2582353 0,50 mm 18-2582353-20 0,50 mm (0.2 mm SHORT)</p>	<p>A = 43,420 B = 69,820 C = 15,850 CD= 46,900</p> <p>Ring Carrier Oil Gallery</p>	<p>RE23350000 -STD RE23350025 -0,25 RE23350050 -0,50</p> <p>2,000 (500) Cr P IF 2,000 (508) P 2,000 (604) Nit S</p>	<p>ø30,0 x 66,9</p>			<p>1,10 mm Gasket +0,38 +0,47</p> <p>1,20 mm Gasket +0,48 +0,58</p> <p>1,30 mm Gasket + 0,59 +0,68</p>



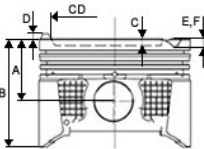







Engine	Ref. No. - Kit 1	Dimensions	Rings	Pin	Piston Liner	Kit 2	Info
<p>ø86,01</p> <p>4 Cyl. Gasoline 2198/2179 cc 155 PS 74 Kw (100 Ps) 15,5:1 2.2L Duratorq/HDI (CUFF,CUF5,CVR5,UYRG)) <u>2002 -</u></p> <p><i>Euro 5 TRANSIT 2.2 (YENI) Boxer 2.2L</i></p>	<p>18-2582420 STD -mm 18-2582420-20 STD -mm (0.2 mm SHORT) 18-2582421 0,25 mm 18-2582423 0,50 mm 18-2582423-20 0,50 mm (0.2 mm SHORT)</p>	<p>A = 48,420 B = 74,820 C = 16,170 CD= 49,040</p> <p>Ring Carrier Oil Gallery Oil Cut-Out</p>	<p>RE23350000 -STD RE23350025 -0,25 RE23350050 -0,50</p> <p>2,000 (500) Cr P IF 2,000 (508) P 2,000 (604) Nit S</p>	<p>ø30,0 x 66,9</p>			
<p>ø83,00</p> <p>R 4 Diesel, 1905 cm³ 55 69 kW (75 94 PS) XUD9ATF XUD9BSD XUD9BTF <u>1993 - 2004</u></p> <p><i>306 1.9 TD 405 1.9 TD 406 1.9 TD 806 1.9 TD Boxer 1.9 TD Ducato 1.9 TD</i></p>	<p>18-7550910 STD -mm 18-7550913 0,50 mm 18-7550917 0,80 mm</p>	<p>A = 46,750 B = 79,250 C = 3,500</p> <p>Hard Anodising</p>	<p>RE22250000 -STD RE22250050 -0,50 RE22250080 -0,80</p> <p>3,000 (504) Cr P 2,000 (501) P 3,000 (604) Cr P</p>	<p>ø28,0 x 68,0</p>			

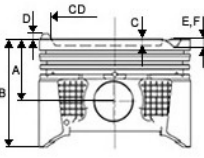

Engine	Ref. No. - Kit 1	Dimensions	Rings	Pin	Piston Liner	Kit 2	Info
<p>ø88,00</p> <p>4 Cyl. Gasoline 1971 cc 57 Kw (78 Ps) XN1P XNA XN1T XN2/3</p> <p><u>1971 - 1993</u></p>	<p>14-7510200 STD -mm 14-7510203 0,50 mm</p>	<p>A = 38,250 B = 71,850 D = 0,650</p>	<p>RE47160000 -STD RE47160050 -0,50</p> <p>1,500 (500) Cr 2,000 (501) 4,000 (700) Cr P S</p>	<p>ø23,0 x 74,1</p>			
<p>ø88,00</p> <p>4 Cyl. Gasoline 1971 cc 57 Kw (78 Ps) XN1T XN1 XN2</p> <p><u>1971 - 1993</u></p> <p>J5 J9 504</p>	<p>18-7510220 STD -mm</p>	<p>A = 37,900 B = 65,450 D = 2,550</p>	<p>RE47160000 -STD RE47160050 -0,50</p> <p>1,500 (500) Cr 2,000 (501) 4,000 (700) Cr P S</p>	<p>ø23,0 x 74,1</p>	<p>G93001356S_1</p> <p>A= 79,500 B= 75,000 D= 89,200 F= 0,000 H= 90,000 L= 135,000</p>		







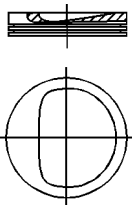

							
Engine	Ref. No. - Kit 1	Dimensions	Rings	Pin	Piston Liner	Kit 2	Info
<p>ø88,00</p> <p>4 Cyl. Diesel 1975/1987/1990 cc 32/40/42/44 Kw (49/54/5760 Ps) VTA XDP4.88 XD 4.88 XD 88 XD P 4.88/4.88/88</p> <p><u>1987....</u></p> <p>504 1.9D 404 1.9D 404 2.0D/504 2.0D J 7 1.9D Granada 2.0D</p>	<p>14-7550930 STD -mm</p>	<p>A = 58,700 B = 95,700 C = 1,950</p>	<p>RE47140000 -STD</p> <p>2,000 (500) Cr 2,000 (501) P 2,000 (508) P 4,500 (604) P</p>	<p>ø28,0 x 68,0</p>			
<p>ø90,00</p> <p>4 Cyl. Diesel 2112 cc 46/43/48/55/78 Kw (59/63/56/75/95/106 Ps) XD4.90 XDP4.90 XDP6.90WTA</p> <p><u>1969....</u></p> <p>J 7 2.1 D 504 2.1 D J 9 2.1 D J 7 2.1 D Granada 2.1 D Blitz 2.1 D</p>	<p>14-7550940 STD -mm 14-7550943 0,50 mm 14-7550948 1,00 mm</p>	<p>A = 57,200 B = 96,350 C = 2,000</p>	<p>RE47170000 -STD RE47170050 -STD RE47170100 -STD</p> <p>2,000 (500) Cr 2,000 (501) P 2,000 (508) P 4,500 (604) P</p>	<p>ø28,0 x 77,0</p>			

							
Engine	Ref. No. - Kit 1	Dimensions	Rings	Pin	Piston Liner	Kit 2	Info
<p>ø92,00</p> <p>4 Cyl. Diesel 2446 cc DJ5 <u>1996 -....</u> Boxer 2,5 D</p>	<p>18-7550530 STD -mm 18-7550533 0,50 mm</p>	<p>A = 49,740 C = 1,750</p>	<p>RE47500000 -STD RE47500050 -0,50</p> <p>2,250 (500) Cr P 2,000 (508) P 3,000 (604) Cr P</p>	<p>ø34,0 x 58,0</p>			<p>+ 0,40 + 0,60</p>
<p>ø92,00</p> <p>4 Cyl. Diesel 2446 cc DJ5TDI TED <u>1997 -....</u> Boxer 2,5 TD</p>	<p>18-7589220 STD -mm 18-7589223 0,50 mm</p>	<p>A = 57,000 B = 89,000 C = 18,250 E = -1,500 CD= 41,000</p> <p>Ring Carrier Oil Gallery</p>	<p>RE47520000 -STD RE47520050 -0,50</p> <p>3,500 (505) MoB N 2,000 (508) P 3,500 (604) Cr P</p>	<p>ø34,0 x 68,0</p>			<p>1,30 mm Gasket + 0,50 + 0,60</p>

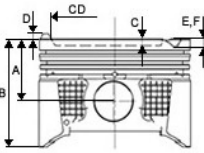







Engine	Ref. No. - Kit 1	Dimensions	Rings	Pin	Piston Liner	Kit 2	Info
<p>ø92,00</p> <p>4 Cyl. 2446 cc 76 96 Kw (103 130 Ps) Turbo DJ5T <u>1997 -.....</u></p> <p>Boxer 2,5 T Citroen Jumper 2,5 T</p>	<p>18-7589330 STD -mm 18-7589333 0,50 mm</p>	<p>A = 49,840 C = 2,300</p> <p>Ring Carrier Hard Anodising Oil Gallery</p>	<p>RE47310000 -STD RE47310050 -0,50</p> <p>3,000 (504) MoB N IF 1,750 (501) Cr IF 3,500 (604) Cr P</p>	<p>ø34,0 x 68,0</p>			<p>+ 0,64 + 0,74</p>
<p>ø93,03</p> <p>4 Cyl. Diesel 2498cc 54 kW (73 PS) 4JB1 <u>1981 - 1994</u></p> <p>Karsan J9 Premier</p>	<p>14-7550870 STD -mm</p>	<p>A = 51,850 B = 91,850 C = 19,500 E = -0,550 CD= 43,900</p> <p>Ring Carrier Steel Support Oil Cut-Out</p>	<p>RE47420000 -STD RE47420050 -0,50</p> <p>2,000 (500) Cr P 2,000 (508) P 4,000 (604) Cr P</p>	<p>ø31,0 x 76,0</p>			<p>0 + 0,70</p>



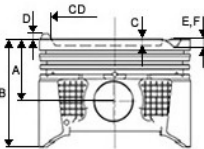





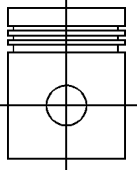



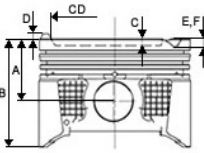

Engine	Ref. No. - Kit 1	Dimensions	Rings	Pin	Piston Liner	Kit 2	Info
<p>ø94,40</p> <p>4 Cyl. Diesel 2798 cc 64 Kw (87 Ps) Sofim Motor 8140.63.3700</p> <p><u>1998 - 1999</u></p> <p><i>Ducato 14 2.8 D</i> <i>Ducato Maxi 2.8D</i></p>	<p>18-2051130 STD -mm 18-2051132 0,40 mm 18-2051134 0,60 mm</p>	<p>A = 55,000 B = 90,000 C = 1,700</p> <p>Ring Carrier Hard Anodising Oil Cut-Out</p>	<p>RE22790000 -STD RE22790040 -0,40 RE22790060 -0,60</p> <p>3,000 (504) Cr P 2,000 (501) P IWU 2,500 (604) Cr P</p>	<p>ø32,0 x 68,0</p>			<p>+ 0,40 + 0,50 (1.20 mm Gasket)</p> <p>+ 0,51 + 0,60 (1.30 mm Gasket)</p> <p>+ 0,61 + 0,70 (1.40 mm Gasket)</p>

							
Engine	Ref. No. - Kit 1	Dimensions	Rings	Pin	Piston Liner	Kit 2	Info
<p>ø69,00</p> <p>4 Cyl. Gasoline 1149 cc 44 Kw (60 Ps) D7F F4P 44KW 700/701/702 706/710/720/ <u>1996 -....</u></p> <p><i>Clio 1.2i</i> <i>Kangoo 1.2i</i> <i>Twingo 1.2i</i></p>	<p>18-8010040 STD -mm 18-8010043 0,50 mm</p>	<p>A = 27,150 B = 50,500</p>	<p>RE49330000 -STD RE49330050 -0,50</p> <p>1,500 (500) Cr P IF 1,500 (501) P IFU 2,500 (604) Cr P</p>	<p>ø17,0 x 53,7</p>			
<p>ø69,00</p> <p>4 Cyl. Gasoline 1200cc 75 D4F 740 <u>1993 - 2009</u></p> <p><i>Clio II</i> <i>Clio III</i> <i>Modus</i> <i>Twingo</i></p>	<p>18-8011040 STD -mm 18-8011043 0,50 mm</p>	<p>A = 26,700 B = 44,700 C = 1,100 CD= 60,300</p>	<p>RE49520000 -STD RE49520050 -0,50</p> <p>1,200 (500) Nit S 1,500 (501) P IF 2,500 (700) Cr P S</p>	<p>ø17,0 x 53,7</p>			

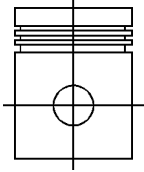



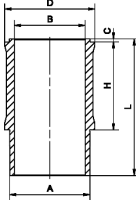

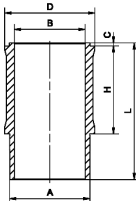



							
Engine	Ref. No. - Kit 1	Dimensions	Rings	Pin	Piston Liner	Kit 2	Info
<p>ø70,00</p> <p>4 Cyl. Gasoline 1108 cc 39 Kw (53 Ps) 688.01 688.02 688.06 688.09 688.10 688.11 688.12 6 <u>1976 - 1990</u></p> <p>R4 R5 R6 R8 R9 R10 R11</p> 	<p>14-8010050 STD -mm</p>	<p>A = 40,000 B = 68,000</p>	<p>RE49030000 -STD</p> <p>1,750 (500) Cr S IF 2,000 (501) P 3,500 (700) Cr P S</p>	<p>ø18,0 x 62,0</p>			
<p>ø73,00</p> <p>4 Cyl. Gasoline 1289 cc 40 Kw (54 Ps) 9,5:1 810.05 <u>1971 - 1989</u></p> <p>R12</p>	<p>14-8010080 STD -mm</p>	<p>A = 37,610 B = 62,500 C = 1,600 CD= 50,000</p>	<p>RE49050000 -STD</p> <p>1,750 (500) Cr S 2,000 (508) P 4,000 (700) Cr P S</p>	<p>ø20,0 x 64,0</p>			

							
Engine	Ref. No. - Kit 1	Dimensions	Rings	Pin	Piston Liner	Kit 2	Info
<p>ø73,00</p> <p>4 Cyl. Gasoline 1289 cc 44 50 Kw (60 68 Ps) 810. 810.01 810.02 810.03 810.05 810.10 810.19 810 <u>1971 - 1984</u></p> <p>R5 R10 R12 R15</p> 	<p>14-8010090 STD -mm</p>	<p>A = 37,500 B = 62,500</p>	<p>RE49050000 -STD</p> <p>1,750 (500) Cr S 2,000 (508) P 4,000 (700) Cr P S</p>	<p>ø20,0 x 64,0</p>			
<p>ø75,80</p> <p>4 Cyl. Gasoline 1171 cc 44 Kw (60 Ps) 9,25:1 Catal.Conv E5FA710 E7F 08 <u>1991 - 1998</u></p> <p>Clio 1.2 RL RN RT</p>	<p>14-8010160 STD -mm</p>	<p>A = 35,100 B = 56,600 C = 1,200</p> <p>Steel Support</p>	<p>RE49410000 -STD RE49410050 -0,50</p> <p>1,500 (500) Cr P 1,750 (501) P IF 3,000 (604) P</p>	<p>ø19,0 x 60,0</p>			

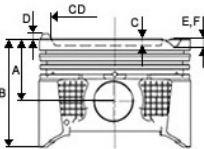
Engine	Ref. No. - Kit 1	Dimensions	Rings	Pin	Piston Liner	Kit 2	Info
<p>ø75,80</p> <p>4 Cyl. Gasoline 1390 cc 55 59 Kw (75 80 Ps) E7J (720/724/726/728/773) E6JA700 <u>1988 -....</u></p> <p><i>Clio 1.4 R 19 1.4 Clio RN-RT Express Kangoo 1.4i R 19 RN-RT-Rti R 19 RL R12 1.4</i></p> 	<p>18-8010180 STD -mm</p>	<p>A = 31,700 B = 52,700</p> <p>Steel Support</p>	<p>RE49260000 -STD</p> <p>1,500 (500) CrB Fe S IF 1,750 (501) P 3,000 (700) Cr P S</p>	<p>ø19,0 x 60,0</p>	<p>G80601300S_1</p> <p>A= 79,500 B= 75,000 D= 89,200 F= 0,000 H= 90,000 L= 135,000</p> 		
<p>ø76,00</p> <p>4 Cyl. Gasoline 1397 cc 43 53 Kw (59 72 Ps) C1/2/3/16 J B14 B14 OE 847 700/720 847.2 715/717/742/768 <u>1981 - 1998</u></p> <p><i>R18/5/19/21 R12 TSW/TX TOROS R9 BVA AUTOMOTIC R9 GTE BRODWAY/SPRING FUEGO RAPID EXPRESS TRAFIC VOLVO 340/343/345</i></p> 	<p>18-8010190 STD -mm</p>	<p>A = 37,500 B = 64,000</p>	<p>RE49070000 -STD RE49070050 -0,50</p> <p>1,750 (500) Cr S IF 2,000 (508) P 4,000 (700) Cr P S</p>	<p>ø20,0 x 64,0</p>	<p>G80551340S_1</p> <p>A= 79,500 B= 75,000 D= 89,200 F= 0,000 H= 90,000 L= 135,000</p> 		<p>O-Ring Bilgi 04x 77,2x1,25</p>



Engine	Ref. No. - Kit 1	Dimensions	Rings	Pin	Piston Liner	Kit 2	Info
<p>ø76,00</p> <p>4 Cyl. Diesel 1461cc 65 KW 90 HP K9K Euro5 OM607</p> <p><u>2010 -.....</u></p> <p>Grand Scenic III 1.5DCI 16V Megane Grandtour III 1.5dCi Megane III 1.5dCi Citane 108/109 A 160 CDi B160 CDi</p>	<p>18-8050840 STD -mm <i>18-8050840-20 STD -mm (0.2 mm SHORT)</i></p> <p>18-8050843 0,50 mm <i>18-8050843-20 0,50 mm (0.2 mm SHORT)</i></p> <p>18-8050848 1,00 mm <i>18-8050848-20 1,00 mm (0.2 mm SHORT)</i></p>	<p>A = 41,667 B = 66,000 C = 13,500 D = 0,430 E = -0,250 CD= 47,000</p> <p>Ring Carrier Oil Cut-Out</p>	<p>RE49400000 -STD RE49400050 -0,50 RE49400100 -1,00</p> <p>2,000 (500) CKP 2,000 (501) P 2,500 (604) CrP</p>	<p>ø26,0 x 60,0</p>			
<p>ø76,00</p> <p>4 Cyl. Diesel 1500 cc 65 PsCommon Rail K9K</p> <p><u>2002 -.....</u></p> <p>Clio Symbol 1.5dci Kangoo 1.5 dci Duster 1.5 dci Logan 1.5 dci Logan Epress 1.5 dci Logan MCV 1.5 dci Logan Pickup 1.5 dci Sandero 1.5 dci</p>	<p>18-8050850 STD -mm 18-8050853 0,50 mm</p>	<p>A = 41,700 B = 66,000 C = 14,000 E = -0,430 F = -0,250 CD= 39,700</p> <p>Ring Carrier Oil Cut-Out</p>	<p>RE49400000 -STD RE49400050 -0,50 RE49400100 -1,00</p> <p>2,000 (500) CKP 2,000 (501) P 2,500 (604) CrP</p>	<p>ø25,0 x 60,0</p>			<p>+0.25 +0.30</p>

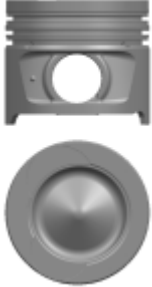
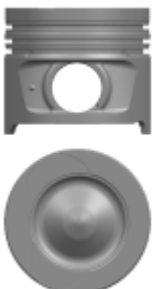

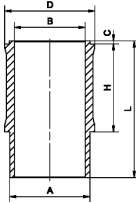
Engine	Ref. No. - Kit 1	Dimensions	Rings	Pin	Piston Liner	Kit 2	Info
<p>ø76,00</p> <p>4 Cyl. Diesel 1500 cc 65 Ps Common Rail K9K BP</p> <p><u>2002 -....</u></p> <p><i>Clio Symbol 1.5 dci</i> <i>Kangoo 1.5 dci</i> <i>Duster 1.5 dci</i> <i>Logan 1.5 dci</i> <i>Logan Express 1.5 dci</i> <i>Logan MCV 1.5 dci</i> <i>Logan Pickup 1.5 dci</i> <i>Sandero 1.5 dci</i></p>	<p>18-8050860 STD -mm <i>18-8050860-20 STD -mm</i> <i>(0.2 mm SHORT)</i></p> <p>18-8050860-40 STD -mm <i>(0.4 mm SHORT)</i></p> <p>18-8050863 0,50 mm <i>18-8050863-20 0,50 mm</i> <i>(0.2 mm SHORT)</i></p> <p>18-8050863-40 0,50 mm <i>(0.4 mm SHORT)</i></p> <p>18-8050868 1,00 mm <i>18-8050868-20 1,00 mm</i> <i>(0.2 mm SHORT)</i></p> <p>18-8050868-40 1,00 mm <i>(0.4 mm SHORT)</i></p>	<p>A = 41,700 B = 66,000 C = 14,000 E = -0,430 F = -0,250 CD= 39,700</p> <p>Ring Carrier</p>	<p>RE49400000 -STD RE49400050 -0,50 RE49400100 -1,00</p> <p>2,000 (500) CKP 2,000 (501) P 2,500 (604) CrP</p>	<p>ø26,0 x 60,0</p>			<p>+0.25 +0.30</p>
<p>ø76,00</p> <p>4 Cyl. Diesel 1461 cc 74 Kw (100 Ps) K9K 728 Euro 3</p> <p><u>2004 -...</u></p> <p><i>Megane II 1,5 DCI</i> <i>Clio</i></p>	<p>18-8088330 STD -mm <i>18-8088330-20 STD -mm</i> <i>(0.2 mm SHORT)</i></p> <p>18-8088333 0,50 mm <i>18-8088333-20 0,50 mm</i> <i>(0.2 mm SHORT)</i></p> <p>18-8088338 1,00 mm</p>	<p>A = 41,700 B = 66,000 C = 14,000 E = -0,430 F = -0,250 CD= 39,700</p> <p>Ring Carrier Oil Gallery Oil Cut-Out</p>	<p>RE49400000 -STD RE49400050 -0,50 RE49400100 -1,00</p> <p>2,000 (500) CKP 2,000 (501) P 2,500 (604) CrP</p>	<p>ø26,0 x 60,0</p>			<p>+0.25 +0.30</p>

							
Engine	Ref. No. - Kit 1	Dimensions	Rings	Pin	Piston Liner	Kit 2	Info
<p>ø76,00</p> <p>4 Cyl. Diesel 1461cc 78 Kw (106 Ps) Turbo, Intercooler K9K 732 Euro4 K9K 764 Euro4 K9K 780 Euro4 K9K 804</p> <p><u>2005 -....</u></p> <p><i>Megane II 1.5 dCi</i> <i>Scenic 1.5 dCi</i> <i>Clio Grandtour 1.5 dCi</i> <i>Clio III 1.5 dCi</i> <i>Modus 1.5 dCi</i> <i>Laguna III 1.5 dCi</i> <i>Kangoo 1.5 dCi</i> <i>Kangoo Be Bop 1.5 dCi</i> <i>Kangoo Express 1.5 dCi</i></p> 	<p>18-8088440 STD -mm <i>18-8088440-20 STD -mm</i> <i>(0.2 mm SHORT)</i></p> <p>18-8088443 0,50 mm <i>18-8088443-20 0,50 mm</i> <i>(0.2 mm SHORT)</i></p> <p>18-8088448 1,00 mm</p>	<p>A = 41,700 B = 66,000 C = 12,800 E = -0,250 F = -0,430 CD= 49,000</p> <p>Ring Carrier Oil Gallery Oil Cut-Out</p>	<p>RE49400000 -STD RE49400050 -0,50 RE49400100 -1,00</p> <p>2,000 (500) CKP 2,000 (501) P 2,500 (604) CrP</p>	<p>ø26,0 x 60,0</p>			<p>+0.25 +0.30</p>
<p>ø76,00</p> <p>4 Cyl. Diesel 1461cc 81KW 110HP 15.5:1 K9K 837/846 EURO5 (2010>) OM607 (2013>)</p> <p><u>2010>2013></u></p> <p><i>Grand Secnic III 1.5DCI16V</i> <i>Megane Grandtour III 1.5dCi</i> <i>Megane III 1.5dCi</i> <i>Citane 111</i> <i>CLA 180 CDi</i> <i>CLA 180 CDi</i> <i>A180 CDi</i> <i>B180 CDi</i></p> 	<p>18-8092830 STD -mm 18-8092833 0,50 mm</p>	<p>A = 41,667 B = 66,000 C = 13,500 E = -0,430 F = -0,250 CD= 47,000</p> <p>Ring Carrier Oil Gallery Oil Cut-Out</p>	<p>RE49400000 -STD RE49400050 -0,50 RE49400100 -1,00</p> <p>2,000 (500) CKP 2,000 (501) P 2,500 (604) CrP</p>	<p>ø26,0 x 60,0</p>			

Engine	Ref. No. - Kit 1	Dimensions	Rings	Pin	Piston Liner	Kit 2	Info
<p>ø77,00</p> <p>4 Cyl. Gasoline 1565 cc 69 Kw (94 Ps) 9:1 C2L <u>1985 - 1995</u></p> <p><i>R 11 Rainbow</i> <i>R 21 Optima</i> 1985-1995</p>	<p>18-8010200 STD -mm</p>	<p>A = 34,000 B = 60,500 C = 1,950 CD= 65,000</p>	<p>RE49350000 -STD</p> <p>1,750 (500) Cr P 2,000 (508) P 4,000 (603) P</p>	<p>ø20,0 x 64,0</p>	<p>G80901340S_1</p> <p>A= 79,500 B= 75,000 D= 89,200 F= 0,000 H= 90,000 L= 135,000</p> 		
<p>ø78,00</p> <p>H4J H4M</p> <p><i>Megane 3</i></p>	<p>18-8010210 STD -mm 18-8010213 0,50 mm</p>	<p>A = 34,300 B = 52,300 C = 7,680 E = -2,800 F = -6,500</p> <p>Hard Anodising</p>	<p>RJ23036A00 -STD - RJ23036C00 -0,02 "</p> <p>1,200 () CrI SV 1,200 () 2,000 () CrI</p>	<p>ø20,0 x 52,2</p>			

Engine	Ref. No. - Kit 1	Dimensions	Rings	Pin	Piston Liner	Kit 2	Info
<p>ø79,50</p> <p>4 Cyl. Gasoline 1598 cc 66 Kw (90 Ps) K7M 702/703/720 744 745/746 1.&2.Sil <u>1996 -....</u></p> <p>1.&2.Sil. Megane 1.6i RL, RN, RT, RXE Megane Coupe Megane Scenic</p>	<p>18-8010650 STD -mm 18-8010653 0,50 mm</p>	<p>A = 29,250 B = 56,300 D = 2,250</p> <p>Steel Support</p>	<p>RE49280000 -STD RE49280050 -0,50</p> <p>1,500 (500) CrB Fe S IF 1,500 (508) P 2,500 (700) Cr P S</p>	<p>ø19,0 x 62,0</p>			
<p>ø79,50</p> <p>4 Cyl. Gasoline 1598 cc 66 Kw (90 Ps) K7M.702/703/720/744 745/746 3.&4.Sil. <u>1996 -....</u></p> <p>3.&4. Sil. Megane 16i RL RN-RT-RXE</p>	<p>18-8010660 STD -mm 18-8010663 0,50 mm</p>	<p>A = 29,250 B = 56,300 D = 2,550</p> <p>Steel Support</p>	<p>RE49280000 -STD RE49280050 -0,50</p> <p>1,500 (500) CrB Fe S IF 1,500 (508) P 2,500 (700) Cr P S</p>	<p>ø19,0 x 62,0</p>			







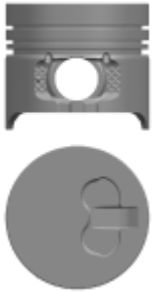
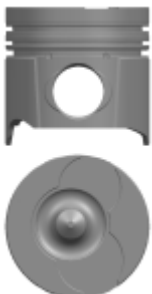

Engine	Ref. No. - Kit 1	Dimensions	Rings	Pin	Piston Liner	Kit 2	Info
<p>ø79,50</p> <p>4 Cyl. Gasoline 1400 cc 55 Kw (75 Ps) K7J <u>1996 -....</u></p> <p><i>Clio Symbol 1.4i 8V Logan 1.4i Logan Express 1.4i Logan MCV 1.4i Logan Pickup 1.4i Sandero 1.4i</i></p> 	<p>18-8010670 STD -mm 18-8010673 0,50 mm</p>	<p>A = 35,830 B = 58,000</p>	<p>RE49280000 -STD RE49280050 -0,50</p> <p>1,500 (500) CrB Fe S IF 1,500 (508) P 2,500 (700) Cr P S</p>	<p>ø19,0 x 62,0</p>			
<p>ø79,50</p> <p>4 Cyl. Gasoline 1600cc 90 HP K7M 732 <u>2004 -....</u></p> <p><i>Clio Dacia Logan 1 6</i></p> 	<p>18-8010680 STD -mm 18-8010683 0,50 mm</p>	<p>A = 28,310 B = 58,810</p>	<p>RE49280000 -STD RE49280050 -0,50</p> <p>1,500 (500) CrB Fe S IF 1,500 (508) P 2,500 (700) Cr P S</p>	<p>ø19,0 x 62,0</p>			

Engine	Ref. No. - Kit 1	Dimensions	Rings	Pin	Piston Liner	Kit 2	Info
<p>ø79,50</p> <p>4 Cyl. Gasoline 1390 cc 72 Kw (98 Ps) 10:1 K4J 730 K4J 710 K4J 780 K4J 770 <u>2004 -....</u></p> <p><i>Megan II 16v</i> <i>Scenic II 16v</i> <i>Clio II 16v</i> <i>Clio III 16v</i> <i>Modus 16v</i></p> 	<p>18-8010690 STD -mm 18-8010693 0,50 mm</p>	<p>A = 37,200 B = 64,500 E = -1,200 F = -2,100</p>	<p>RE49280000 -STD RE49280050 -0,50</p> <p>1,500 (500) CrB Fe S IF 1,500 (508) P 2,500 (700) Cr P S</p>	<p>ø20,0 x 62,0</p>			
<p>ø79,50</p> <p>4 Cyl. Gasoline 1598 cc 110 115 Ps K4M 760 761 <u>2002 -....</u></p> <p><i>Megane II 1.6 16 V Sedan</i> <i>Méga</i></p> 	<p>18-8010700 STD -mm 18-8010703 0,50 mm</p>	<p>A = 31,700 B = 55,000 C = 1,500 E = -4,000</p> <p>Hard Anodising</p>	<p>RE49270000 -STD RE49270050 -0,50</p> <p>1,200 (500) CrB Fe S 1,500 (508) P 2,500 (700) Cr P S</p>	<p>ø20,0 x 62,0</p>			

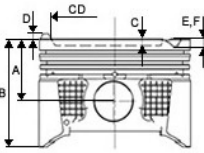
Engine	Ref. No. - Kit 1	Dimensions	Rings	Pin	Piston Liner	Kit 2	Info
<p>ø79,50</p> <p>4 Cyl. Gasoline 1600 cc 95/107/110/116 Ps K4M 708/730/732/750 752/753/754</p> <p><u>1998 -....</u></p> <p>Kango 1.6 16V Megane I 1.6 16V Clio 1.6 16V Laguna 1.6 16V</p>	<p>18-8010710 STD -mm 18-8010713 0,50 mm</p>	<p>A = 31,700 B = 55,000 C = 1,400 E = -2,000 CD= 29,400</p>	<p>RE49280000 -STD RE49280050 -0,50</p> <p>1,500 (500) CrB Fe S IF 1,500 (508) P 2,500 (700) Cr P S</p>	<p>ø20,0 x 62,0</p>			
<p>ø80,00</p> <p>4 Cyl. Diesel 1870 cc 47 Kw (64 Ps) 21,5:1 F8Q.706</p> <p><u>1990 - 1996</u></p> <p>Megane 19 D R 19 D Express Solenza 1.9 D</p>	<p>18-8050900 STD -mm 18-8050903 0,50 mm 18-8050908 1,00 mm</p>	<p>A = 42,250 B = 70,500 C = 0,700</p> <p>Ring Carrier</p>	<p>RE49100000 -STD RE49100050 -0,50 RE49100080 -0,80 RE49100100 -1,00</p> <p>2,000 (500) CrB S 2,000 (501) P 3,000 (604) Cr P</p>	<p>ø24,0 x 63,0</p>			<p>+0.6 +0.8</p>



Engine	Ref. No. - Kit 1	Dimensions	Rings	Pin	Piston Liner	Kit 2	Info
<p>ø80,00</p> <p>4 Cyl. Diesel 1870 cc 47 Kw (64 Ps) 21,5:1 F8Q.630/632/662 <u>1998 -....</u></p> <p><i>Kangoo 1.9 D</i> <i>Solenza 1.9 D</i></p>	<p>18-8050920 STD -mm <i>18-8050920-20 STD -mm</i> <i>(0.2 mm SHORT)</i></p> <p>18-8050923 0,50 mm <i>18-8050923-20 0,50 mm</i> <i>(0.2 mm SHORT)</i></p> <p>18-8050928 1,00 mm <i>18-8050928-20 1,00 mm</i> <i>(0.2 mm SHORT)</i></p> 	<p>A = 42,250 B = 70,500 C = 1,580</p>	<p>RE49100000 -STD RE49100050 -0,50 RE49100080 -0,80 RE49100100 -1,00</p> <p>2,000 (500) CrB S 2,000 (501) P 3,000 (604) Cr P</p>	<p>ø24,0 x 63,0</p>			
<p>ø80,00</p> <p>4 Cyl. Diesel 1870 cc 74 Kw (100Ps)18.3: Turbo, Intercooler F9Q. Turbo Intercooler <u>2000 -...</u></p> <p><i>Kangoo 1.9 Tdi</i> <i>Megane 1.9 Tdi</i> <i>Laguna 1.9 Tdi</i> <i>Scenic 1.9 Tdi</i> <i>Traffic 1.9 Tdi</i> <i>Carlisma 1.9 GDI</i> <i>Vivaro 1,9 CDTI 8 v</i></p>	<p>18-8050940 STD -mm 18-8050943 0,50 mm</p> 	<p>A = 47,060 B = 77,000 C = 17,800 E = -0,750 CD= 38,000</p> <p>Ring Carrier Oil Cut-Out</p>	<p>RE49380000 -STD RE49380050 -0,50</p> <p>2,500 (500) CKP 2,000 (501) P 3,000 (604) Cr</p>	<p>ø28,0 x 60,0</p>			<p>+0,60 +0,80</p>



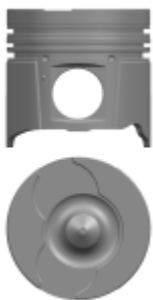
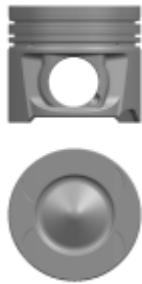



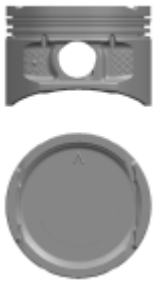
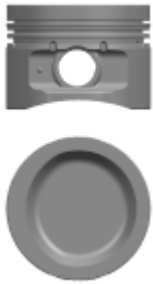

							
Engine	Ref. No. - Kit 1	Dimensions	Rings	Pin	Piston Liner	Kit 2	Info
<p>ø80,00</p> <p>4 Cyl. Diesel 1598cc 96 KW 130PS R9M 402 <u>2015 -</u> Qashgai (2015 -)</p>	<p>18-8092820 STD -mm 18-8092823 0,50 mm</p>	<p>A = 46,000 B = 70,500 C = 12,350 E = -0,300 CD= 46,500</p> <p>Ring Carrier Oil Gallery Oil Cut-Out</p>	<p>RE49510000 -STD RE49510050 -0,50</p> <p>2,000 (500) Cpk 1,750 (501) P IFU 2,000 (604) Cr P</p>	<p>ø30,0 x 60,0</p>			
<p>ø80,00</p> <p>4 Cyl. Diesel 1900 cc 81/97Kw 110/132 Ps F9Q 266/759/803/804-..... MEGANE II 1.9 dCi SCENIC II J 1.9dCi</p>	<p>18-8092950 STD -mm 18-8092953 0,50 mm</p>	<p>A = 47,004 B = 77,000 C = 17,800 E = -0,850 F = -0,850 CD= 40,000</p> <p>Ring Carrier Oil Gallery Oil Cut-Out</p>	<p>RE49380000 -STD RE49380050 -0,50</p> <p>2,500 (500) CKP 2,000 (501) P 3,000 (604) Cr</p>	<p>ø28,0 x 60,0</p>			



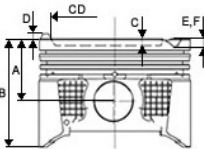





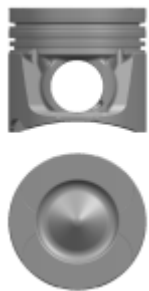

Engine	Ref. No. - Kit 1	Dimensions	Rings	Pin	Piston Liner	Kit 2	Info
<p>ø80,01</p> <p>4 Cyl. Diesel 1870cc 66/81/88 Kw (95/110/120 Ps) F9Q (650/664/670 674/750/756/758 756/812/816/818 808/820/826 <u>1999 - 2009</u></p> <p><i>Megane/Laguna II 1.9 dCi Grandtour II 1.9 dCi Scenic/Clio III 1.9 dCi Megane Grandtour 1.9 dCi Grand Scenic II 1.9 dCi Espace IV 1.9 dCi</i></p>	<p>18-8092930 STD -mm 18-8092933 0,50 mm</p>	<p>A = 47,040 B = 77,000 C = 17,800 E = -0,750 CD= 38,000</p> <p>Ring Carrier Oil Gallery Oil Cut-Out</p>	<p>RE49380000 -STD RE49380050 -0,50</p> <p>2,500 (500) CKP 2,000 (501) P 3,000 (604) Cr</p>	<p>ø28,0 x 60,0</p>			
<p>ø81,00</p> <p>4 Cyl. Gasoline 1721 cc 59/60.5/60/90KW (80/82/122 PS) 10:1 F2NA 700/E708 B18E/F/FP/FT <u>1984 - 1989</u></p> <p><i>Flash R11 GTX/TXE R21 ELECTRONIC R9 GTX/TXE VOLVO 440/460/480</i></p>	<p>18-8010800 STD -mm 18-8010803 0,50 mm</p>	<p>A = 44,050 B = 70,000 C = 13,870 CD= 59,970</p> <p>Steel Support</p>	<p>RE49110000 -STD RE49110050 -0,50</p> <p>1,750 (500) CrB S IF 2,000 (508) P 3,000 (700) Cr P S</p>	<p>ø21,0 x 65,0</p>			

Engine	Ref. No. - Kit 1	Dimensions	Rings	Pin	Piston Liner	Kit 2	Info
<p>ø82,70</p> <p>4 Cyl. Gasoline 2000 cc F3R 722/723/728/729 <u>1994 -....</u></p> <p>Laguna 1 Megane Scenic 2.0</p>	<p>18-8010400 STD -mm 18-8010403 0,50 mm</p>	<p>A = 36,170 B = 60,000 C = 9,000 CD= 67,400</p> <p>Steel Support</p>	<p>RE49300000 -STD RE49300050 -0,50</p> <p>1,500 (500) CrB Fe S IF 1,750 (501) P 3,000 (700) Cr P S</p>	<p>ø21,0 x 57,0</p>			
<p>ø82,70</p> <p>4 Cyl. Gasoline 1998 cc 140 Ps F4R 770 F 4R 771 <u>2002 -....</u></p> <p>Scenic II 2,0 16v Megane II 2.0 16V</p>	<p>18-8010410 STD -mm 18-8010413 0,50 mm</p>	<p>A = 30,500 B = 56,900 C = 2,200 E = -1,200 F = -2,000</p>	<p>RE49430000 -STD RE49430050 -0,50</p> <p>1,200 (500) NitB S 1,500 (508) P 2,000 (700) Cr P S</p>	<p>ø21,0 x 61,0</p>			

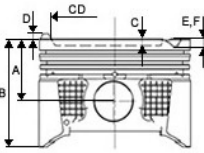







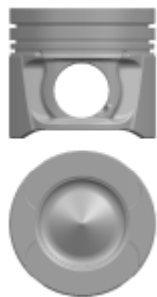

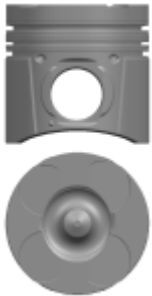
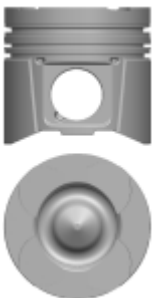
							
Engine	Ref. No. - Kit 1	Dimensions	Rings	Pin	Piston Liner	Kit 2	Info
<p>ø82,70</p> <p>4 Cyl. Gasoline 1998 cc 103 Kw (140 Ps) F4R 780 F 4 R 740 F 4 R 712 <u>1999 - 2003</u></p> <p>Laguna 2,0 Mégane Scenic 2,0 16v Laguna 2,0 16v</p>	<p>18-8010420 STD -mm 18-8010423 0,50 mm</p>	<p>A = 30,300 B = 56,800 C = 2,600 E = -1,600 F = -2,000</p>	<p>RE49430000 -STD RE49430050 -0,50</p> <p>1,200 (500) NitB S 1,500 (508) P 2,000 (700) Cr P S</p>	<p>ø21,0 x 61,0</p>			
<p>ø84,00</p> <p>4 Cyl. Diesel 1995 cc 66 84 KW (90 114 PS) 16:1 127 KW (173 PS) M9R 780 EURO 4 2006> M9R 839 2008> <u>2006/2008 -</u></p> <p>Box - Bus dCi 120 Primaster Bus 120 Koleos 2.0 dCi</p>	<p>18-8092440 STD -mm 18-8092443 0,50 mm</p>	<p>A = 48,000 B = 76,000 C = 14,850 E = -0,400 CD= 49,150</p> <p>Ring Carrier Oil Gallery</p>	<p>RE49470000 -STD RE49470050 -0,50</p> <p>2,500 (503) Cr P 2,000 (501) Cr P IFU 2,000 (604) Nit S</p>	<p>ø32,0 x 65,0</p>			

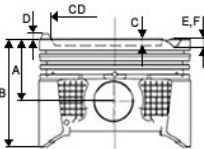

							
Engine	Ref. No. - Kit 1	Dimensions	Rings	Pin	Piston Liner	Kit 2	Info
<p>ø85,01</p> <p>4 Cyl. Diesel 2298 cc 74/107 Kw (101/146 Ps) M9T EURO 4/5 <u>2010 -....</u> Master III 2.3 DCi 100 Master III 2.3 DCi 125</p>	<p>18-8092430 STD -mm 18-8092433 0,50 mm</p>	<p>A = 48,000 B = 76,000 C = 14,850 E = -0,400 CD= 49,150</p> <p>Ring Carrier Oil Gallery</p>	<p>RE49480000 -STD RE49480050 -0,50</p> <p>2,500 (503) Cr P 2,000 (501) Cr P IFU 2,000 (604) Nit S</p>	<p>ø32,0 x 65,0</p>			
<p>ø86,00</p> <p>4 Cyl. Diesel 2068 cc 44/46/47/49/ Kw 51/56/65/68 Kw (60/63/64/70 ps /76/88/92 Ps) 852 700 J8S 330/600/704/784/800 J8S 604/620/711/736 J8S 712 <u>1983 -....</u> R 18/20/21/25 2.1D R 18/21 2.1TD Trafic 2.1D/Fuego 2.1TD Master T28 2.1D Jeep CJ-7 2.1D</p>	<p>14-8050430 STD -mm</p>	<p>A = 51,000 B = 92,900 C = 4,200</p>	<p>RE49130000 -STD</p> <p>2,000 (500) Cr IF 2,000 (501) PIW 4,000 (604) Cr P</p>	<p>ø28,0 x 75,0</p>			









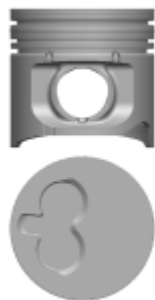

Engine	Ref. No. - Kit 1	Dimensions	Rings	Pin	Piston Liner	Kit 2	Info
<p>ø87,00</p> <p>4 Cyl. Diesel 2188cc 66 Kw(90 Ps) 18:1 Turbo , Intercooler C.Rail G9T 722/720/750 <u>2000 -.....</u></p> <p><i>(Turbo-Intercooler/C.Rail)</i> Movano 2.2 DTI 16v Espace IV 2.2 TDCI Laguna 2.2 TDCI Master 2.2 TDCI Velsatis 2.2 TDCI</p> 	<p>18-8050330 STD -mm 18-8050333 0,50 mm</p>	<p>A = 54,530 B = 84,200 C = 17,500 E = -1,600 F = -2,000 CD= 40,400</p> <p>Ring Carrier Oil Cut-Out</p>	<p>RE49440000 -STD RE49440050 -0,50</p> <p>3,000 (503) CKP 1,750 (501) P 2,500 (604) P</p>	<p>ø31,0 x 65,0</p>			<p>+0.6 +0.40</p>
<p>ø89,00</p> <p>4 Cyl. Diesel 2463 cc 84 Kw (115 Ps) 17.75:1 Common Rail G9U Euro 3 720/724/730/750/754 <u>2001-2006</u></p> <p>Master II 2,5 Dci OPEL/Movano Box Movano Platform Vivaro Box Vivaro Platform</p> 	<p>18-3050290 STD -mm 18-3050290-20 STD -mm (0.2 mm SHORT) 18-3050293 0,50 mm 18-3050293-20 0,50 mm (0.2 mm SHORT)</p>	<p>A = 53,030 B = 83,090 C = 17,850 E = -1,600 F = -2,000 CD= 43,200</p> <p>Ring Carrier Oil Cut-Out</p>	<p>RE49450000 -STD RE49450050 -0,50</p> <p>2,500 (500) Cr P IF 1,750 (501) P IFU 2,500 (604) Cr P</p>	<p>ø31,0 x 65,0</p>			<p>+0,35 +0,60</p>

							
Engine	Ref. No. - Kit 1	Dimensions	Rings	Pin	Piston Liner	Kit 2	Info
<p>ø89,00</p> <p>4 Cyl. Diesel 2463 cc 84 Kw (115 Ps) 17.75 G9U Euro 4 632/650 <u>2001-2006</u></p> <p><i>Master II 2,5 Dci OPEL/Movano Box Movano Platform Vivaro Box Vivaro Platform</i></p>	<p>18-3050300 STD -mm 18-3050303 0,50 mm</p>	<p>A = 53,075 B = 83,090 C = 16,130 E = -1,600 F = -2,000 CD= 48,000</p> <p>Ring Carrier</p>	<p>RE49490000 -STD RE49490050 -0,50</p> <p>3,000 (503) Cr P 1,750 (508) P 2,500 (604) Nit S</p>	<p>ø31,0 x 65,0</p>			
<p>ø89,00</p> <p>4 Diesel, 2464 cm³ 74/107 kW (101/146 PS) 18:1 18,1:1,16 Ventile G9U 630 G9U 632 G9U 650 <u>10/2003</u></p> <p><i>INTERSTAR DCI 100/120/150 PRIMASTAR DCI 150 MOVANO-A 2.5 CDTI VIVARO 2.5 CDTI/DTI TRAFIC II 2.5 DCI MASTER II 2.5 DCI</i></p>	<p>18-3092350 STD -mm 18-3092351 0,25 mm 18-3092353 0,50 mm</p>	<p>A = 53,075 B = 83,090 C = 16,300 E = -2,000 F = -1,700 CD= 48,000</p> <p>Ring Carrier Oil Gallery Oil Cut-Out</p>	<p>RE49490000 -STD RE49490050 -0,50</p> <p>3,000 (503) Cr P 1,750 (508) P 2,500 (604) Nit S</p>	<p>ø31,0 x 68,0</p>			

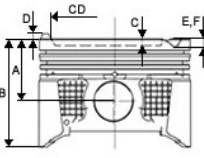
Engine	Ref. No. - Kit 1	Dimensions	Rings	Pin	Piston Liner	Kit 2	Info
<p>ø92,90</p> <p>V6/8 Gasoline, 3498/4663 cm³ 190/215250 kW (258/292/340 PS) 10:1/12,2:1,24Ventile 10,7:1,32Ventile M 272.960/961,964/967 970 972/975,977/980 988/991 Euro 4 M 273.922/924 2005 -</p> <p>C 350 CLC 350 CLS 350 E 350 E 350 T GLK 350 ML 350 R 350 S 350 SL 350 SPRINTER 3 SPRINTER 224/424/524 VITO 126 3.5 VIANO 3.5 GL 450 S 450</p>	<p>14-5010330 STD -mm</p>	<p>A = 30,430 B = 50,830 E = -1,550</p>	<p>RE15260000 -STD ø20,0 RE15260000_NPR -STD ø48,0 RE15260050 -0,50 RE15260050_NPR -0,50</p> <p>1,200 (500) Cr S IF 1,500 (508) P 2,000 (700) Cr P S</p>				
<p>ø93,00</p> <p>4 Cyl. Diesel 2499 cc 62 Kw (85 Ps) Atmospheric SOFIM 2/5 Düz 2001 -</p> <p>Ducato 2.5 D Movano 2.5 D Master 2.5 D</p>	<p>18-3051880 STD -mm 18-3051880-20 STD -mm (0.2 mm SHORT) 18-3051882 0,40 mm 18-3051882-20 0,40 mm (0.2 mm SHORT)</p>	<p>A = 54,000 B = 89,000 C = 2,200</p> <p>Ring Carrier Hard Anodising Oil Cut-Out</p>	<p>RE22340000 -STD ø32,0 RE22340040 -0,40 x 68,0 RE22340060 -0,60</p> <p>3,000 (504) Cr P 2,000 (501) P 3,000 (604) Cr P</p>				<p>+0,40 +0,50 1.20 mm Gasket</p> <p>+0,51 +0,60 1.30 mm Gasket</p> <p>+0,61 +0,70 1.40 mm Gasket</p>









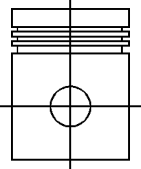

Engine	Ref. No. - Kit 1	Dimensions	Rings	Pin	Piston Liner	Kit 2	Info
<p>ø73,00</p> <p>4 Cyl. Diesel 1364 cc 90 Ps 1ND TV <u>2005 -....</u></p> <p><i>Corolla 1.4D-4D Auris 1.4D-4D Yaris 1.4D-4D</i></p>	<p>18-4592100 STD -mm <i>18-4592100-20 STD -mm (0.2 mm SHORT)</i></p> <p>18-4592103 0,50 mm <i>18-4592103-20 0,50 mm (0.2 mm SHORT)</i></p>	<p>A = 41,940 B = 64,350 C = 14,700 E = -0,900 CD= 36,500</p> <p>Ring Carrier Hard Anodising Oil Gallery</p>	<p>RJ28084A00 -STD - " ø27,0 RJ28084C00 -0,02 " x 59,3</p> <p>1,500 () GN SM 1,200 () RN CrI 2,000 () GN</p>				

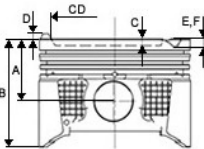
							
Engine	Ref. No. - Kit 1	Dimensions	Rings	Pin	Piston Liner	Kit 2	Info
<p>ø67,10</p> <p>R 4 Petrol, 999 cm³ 37 kW (50 hp), 10,5/7:1 8 Ventile AER ALL <u>1996 - 2005</u></p> <p><i>Polo 1.0 Lupo 1.0 Arosa 1.0 Cordoba I 1.0 I Ibiza II 1.0 I</i></p>	<p>18-7010340 STD -mm 18-7010343 0,50 mm</p>	<p>A = 31,270 B = 56,270 C = 5,700 CD= 51,000</p>	<p>RE56080000 -STD RE56080050 -0,50</p> <p>1,000 (500) CrB S IF 1,200 (508) P 2,000 (700) Cr P S</p>	<p>ø17,0 x 45,0</p>			
<p>ø69,50</p> <p>4 sil.benzin 1100 cc FA FJ GG HB <u>04/74 - 07/83</u></p> <p><i>Golf Polo Jetta Audi 50</i></p>	<p>18-1910010 STD -mm 18-1910013 0,50 mm</p>	<p>A = 40,200</p>	<p>RE53050000 -STD RE53050050 -0,50</p> <p>1,500 (500) Cr S 1,500 (501) P 3,000 (700) Cr S P</p>	<p>ø100,0 x 0,0</p>			

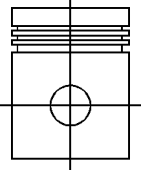
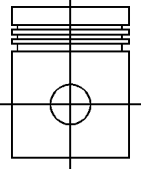

Engine	Ref. No. - Kit 1	Dimensions	Rings	Pin	Piston Liner	Kit 2	Info
<p>ø69,50</p> <p>R 4 Petrol, 895 cm³ 29,5 kW (40 hp), 8:1 FA FJ GG HB <u>1974 -....</u></p> <p><i>Golf Polo Jetta Audi 50</i></p> 	<p>18-7010010 STD -mm 18-7010013 0,50 mm</p>	<p>A = 40,200 B = 67,000 C = 4,000</p>	<p>RE53050000 -STD RE53050050 -0,50</p> <p>1,500 (500) Cr S 1,500 (501) P 3,000 (700) Cr S P</p>	<p>ø20,0 x 54,0</p>			
<p>ø69,50</p> <p>R 4 Petrol, 895 cm³ 29,5 kW (40 hp), 8:1 HB HD <u>1974 -....</u></p> <p><i>Polo 1.1 Derby 1.1</i></p> 	<p>14-7010040 STD -mm 14-7010043 0,50 mm</p>	<p>A = 40,350 B = 64,350</p>	<p>RE56000000 -STD RE56000050 -0,50 RE56000100 -1,00</p> <p>1,750 (500) Cr P IF 2,000 (508) P 4,000 (603) P</p>	<p>ø20,0 x 58,0</p>			

							
Engine	Ref. No. - Kit 1	Dimensions	Rings	Pin	Piston Liner	Kit 2	Info
<p>ø69,50</p> <p>R 4 Petrol, 895 cm³ 29,5 kW (40 hp), 8:1 HB HD <u>1974 -....</u> <i>Polo 1.1</i> <i>Derby 1.1</i></p> 	<p>14-7010040 STD -mm 14-7010043 0,50 mm</p>	<p>A = 40,350 B = 64,350</p>	<p>RE56000000 -STD RE56000050 -0,50 RE56000100 -1,00</p> <p>1,750 (500) Cr P IF 2,000 (508) P 4,000 (603) P</p>	<p>ø20,0 x 58,0</p>			
<p>ø75,00</p> <p>R 4 Petrol, 1272 cm³ 40 kW (55 hp), 8,2:1 FY FZ GF GS GT HH HJ <u>1979 -....</u> <i>Golf</i> <i>Jetta</i> <i>Passat</i> <i>Santana</i></p> 	<p>14-7010050 STD -mm 14-7010053 0,50 mm</p>	<p>A = 38,300 B = 66,300</p>	<p>RE56020000 -STD RE56020050 -0,50 RE56020100 -1,00</p> <p>1,750 (500) CrB S IF 2,000 (508) P 4,000 (700) Cr P S</p>	<p>ø20,0 x 58,0</p>			

Engine	Ref. No. - Kit 1	Dimensions	Rings	Pin	Piston Liner	Kit 2	Info
<p>ø75,00</p> <p>R 4 Petrol, 1296 cm³ 44 kW (60 hp), 8,5:1 ZA ZF</p> <p><u>1972 - 1983</u></p> <p>Audi 80 1.3 VW Passat 1.3</p>	<p>14-7010060 STD -mm 14-7010063 0,50 mm</p>	<p>A = 45,500 B = 77,500 C = 4,500 CD= 57,800</p>	<p>RE56040000 -STD RE56040050 -0,50 RE56040100 -1,00</p> <p>2,000 (500) CrB Fe S IF 2,500 (508) P 4,000 (700) Cr P S</p>	<p>ø22,0 x 63,0</p>			
<p>ø75,00</p> <p>R 4 Petrol, 1272 cm³ 40 kW (54 hp), 9,5:1 AAV HK HW MH NU NZ 2G</p> <p><u>1985 - 1992</u></p> <p>Polo Golf Jetta Derby Ibiza II 1.3 I</p>	<p>18-7010260 STD -mm 18-7010263 0,50 mm</p>	<p>A = 42,870 B = 64,870 C = 16,600 E = -1,500 F = -1,650 CD= 56,600</p>	<p>RE56030000 -STD RE56030050 -0,50 RE56030100 -1,00</p> <p>1,750 (500) CrB Fe S IF 2,000 (508) P 3,000 (700) Cr P S</p>	<p>ø20,0 x 54,0</p>			

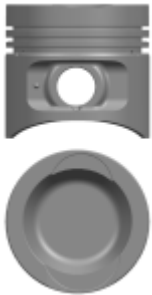
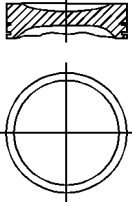







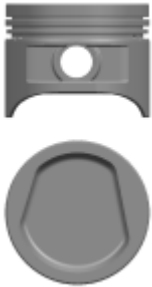
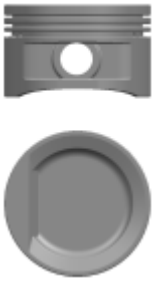

Engine	Ref. No. - Kit 1	Dimensions	Rings	Pin	Piston Liner	Kit 2	Info
<p>ø75,00</p> <p>4 Cyl. Gasoline 1043 cc 33 Kw (45 Ps) 9.8: AAU <u>1990 - 1994</u></p> <p><i>Golf Polo Vento (1990-1994)</i></p>	<p>14-7010360 STD -mm</p>	<p>A = 47,370 B = 73,500 C = 6,800 CD= 1,000</p> <p>Steel Support</p>	<p>RE56070000 -STD</p> <p>1,500 (500) CrB Fe S IF 1,500 (501) P 2,500 (700) Cr P S</p>	<p>ø20,0 x 50,0</p>			
<p>ø76,50</p> <p>4 Cyl. Gasoline 1390cc 103 Kw (140/170 Hp) BMY BLG CAVD <u>2006 -....</u></p> <p><i>GOLF 1.4 TSI JETTA 1.4 TSI Jetta 1.4TSI16V Touran 1.4FSI16V Touran 1.4 TSI16V Golf Plus 1.4TSI16V Golf V 1.4FSI+TSI16V Tiguan 1.4TSI16V Scirocco 1.4TSI16V Beetle 1.4TSI</i></p>	<p>18-7010280 STD -mm 18-7010280-30 STD -mm 18-7010283 0,50 mm 18-7010283-30 0,50 mm</p>	<p>A = 29,000 B = 48,200 C = 5,900 D = 1,850 E = -1,100 F = -3,900</p> <p>Hard Anodising</p>	<p>RE56200000 -STD RE56200050 -0,50</p> <p>1,200 (500) NitBS 1,500 (501) P 2,000 (700) NitS</p>	<p>ø19,0 x 54,0</p>			

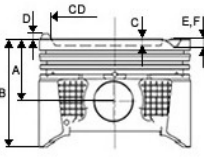







Engine	Ref. No. - Kit 1	Dimensions	Rings	Pin	Piston Liner	Kit 2	Info
<p>ø76,50</p> <p>R 4 Petrol, 1598 cm³ 55 kW (75 hp), 9,3:1 ABU <u>1992 - 1999</u></p> <p><i>Golf III</i> <i>Polo</i> <i>Vento</i></p>	<p>14-7010510 STD -mm 14-7010513 0,50 mm</p>	<p>A = 32,000 B = 54,000 C = 8,700 CD= 64,000</p>	<p>RE56090000 -STD RE56090050 -0,50</p> <p>1,500 (500) CrB Fe S IF 1,500 (508) P 2,500 (700) Cr P S</p>	<p>ø17,0 x 52,0</p>			
<p>ø76,50</p> <p>4 Cyl. Gasoline 1390 cc 40 44 Kw (54 60 Ps) AEX <u>1995 - 1997</u></p> <p><i>Golf</i> <i>Polo</i> <i>Vento/1389 cc</i></p>	<p>18-7010530 STD -mm 18-7010533 0,50 mm</p>	<p>A = 28,350 B = 50,350 C = 5,900</p>	<p>RE56310000 -STD RE56310050 -0,50</p> <p>1,200 (500) NitB S IF 1,500 (508) P 2,500 (700) Cr P S</p>	<p>ø17,0 x 52,0</p>			



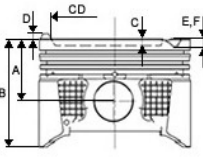

Engine	Ref. No. - Kit 1	Dimensions	Rings	Pin	Piston Liner	Kit 2	Info
<p>ø76,50</p> <p>4 Cyl. Gasoline 1598 cc 55 Kw (75 Ps) 9.8:1 AEA AEE AHS ALM <u>1994 - 1999</u></p> <p><i>Golf Polo Vento Felicia Octavia</i></p> 	<p>18-7010540 STD -mm 18-7010543 0,50 mm</p>	<p>A = 30,850 B = 60,400 C = 8,000</p>	<p>RE56310000 -STD RE56310050 -0,50</p> <p>1,200 (500) NitB S IF 1,500 (508) P 2,500 (700) Cr P S</p>	<p>ø17,0 x 52,0</p>			
<p>ø76,50</p> <p>R 4 Petrol, 1390 cm³ 44 kW (60 hp) AKK ANW AUD <u>1996 -....</u></p> <p><i>Golf Polo Vento</i></p> 	<p>18-7010610 STD -mm 18-7010613 0,50 mm</p>	<p>A = 28,500 B = 48,500 C = 5,360</p>	<p>RE56310000 -STD RE56310050 -0,50</p> <p>1,200 (500) NitB S IF 1,500 (508) P 2,500 (700) Cr P S</p>	<p>ø17,0 x 52,0</p>			

							
Engine	Ref. No. - Kit 1	Dimensions	Rings	Pin	Piston Liner	Kit 2	Info
<p>ø76,50</p> <p>4 Cyl. Gasoline 1390cc 90 92 KW(122 125 BG) CAX CAXA CMSA <u>2007 -....</u></p> <p>VW EOS 1.4FSI16V VW Golf Plus 1.4FSI16V Golf V 1.4FSI16V Golf V 1.4TFSI16V Golf V 1.4TFSI16V Jetta 1.4FSI16V Passat 1.4FSI16V Scirocco 1.4TFSI16V</p>	<p>18-7010630 STD -mm 18-7010633 0,50 mm</p>	<p>A = 29,200 B = 48,200 C = 4,500 E = -3,600 F = -0,700</p> <p>Hard Anodising</p>	<p>RE56450000 -STD RE56450050 -0,50</p> <p>1,200 (500) NitB S 1,200 (501) P 2,000 (700) Nit S</p>	<p>ø19,0 x 52,0</p>			
<p>ø76,50</p> <p>4 Cyl. Gasoline 1390cc 103 KW (170 Ps) BMY BLG CAVD <u>2006 -....</u></p> <p>Jetta 1.4TFSI16V Touran 1.4FSI16V Touran 1.4 TFSI16V Golf Plus 1.4TFSI16V Golf V 1.4FSI+TFSI16V Tiguan 1.4TFSI16V Scirocco 1.4TFSI16V Beetle 1.4TFSI</p>	<p>18-7010640 STD -mm 18-7010643 0,50 mm</p>	<p>A = 29,000 B = 48,200 C = 5,900 D = 1,850 E = -1,100 F = -3,900</p> <p>Hard Anodising</p>	<p>RE56200000 -STD RE56200050 -0,50</p> <p>1,200 (500) NitBS 1,500 (501) P 2,000 (700) NitS</p>	<p>ø19,0 x 52,0</p>			

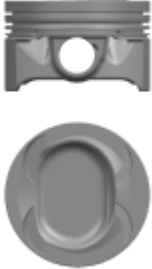
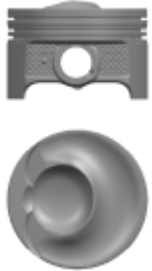





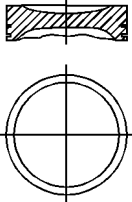

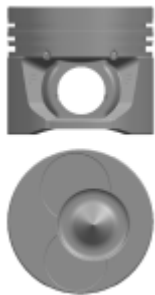
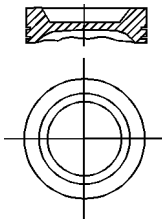

							
Engine	Ref. No. - Kit 1	Dimensions	Rings	Pin	Piston Liner	Kit 2	Info
<p>ø76,50</p> <p>4 Cyl. Gasoline 1390cc 118/136/110/132W 160ps CTJA/CTHG/CAVG CAVE/CTHA/CAVA CTHE/CTKA/CTHD CNWA/CAVD/CNWA CAVC/CAVB/CTHC CTHB</p> <p><u>2008 - 2014</u></p> <p>Touran/Golf/Plus Jetta/Tiguan Eos/Passat Scirocco/A1 Ibiza/Alhambra Fabia RS Sharan Passat CC Polo GTI (1.4 TSI/16V)</p>	<p>18-7010650 STD -mm 18-7010653 0,50 mm</p> <div data-bbox="336 860 488 1128">  </div>	<p>A = 28,970 B = 49,970 C = 4,570 D = 2,000 E = -4,000 F = -1,300</p> <p>Ring Carrier</p>	<p>RE56200000 -STD RE56200050 -0,50</p> <p>1,200 (500) NitBS 1,500 (501) P 2,000 (700) Nits</p>	<p>ø19,0 x 54,0</p>			
<p>ø76,50</p> <p>4 Cyl. Gasoline 1600 cc 115 Ps BAG BLF BLP</p> <p><u>2003 -....</u></p> <p>Golf V Passat Jetta</p>	<p>18-7010660 STD -mm 18-7010663 0,50 mm</p> <div data-bbox="336 1715 488 1984">  </div>	<p>A = 29,300 B = 49,300 C = 6,000 D = 4,500 E = -2,800</p> <p>Hard Anodising</p>	<p>RE56450000 -STD RE56450050 -0,50</p> <p>1,200 (500) NitB S 1,200 (501) P 2,000 (700) Nit S</p>	<p>ø17,0 x 47,0</p>			

Engine	Ref. No. - Kit 1	Dimensions	Rings	Pin	Piston Liner	Kit 2	Info
<p>ø76,50</p> <p>4 Cyl. Diesel 1588 cc 2383 cc 37/40/44/51 /55/57/60,5 Kw (50/54/60/69/75/78/82 Ps) D24 ADK CR JK JP CY JR JX MF ATC 1S CP DW 751</p> <p><u>1980 - 1992</u></p> <p>Volvo 240D/244D/245D/740D Golf Polo Bora Audi 80 1.6D/TD Audi 90 1.6TD Audi 100 2.0D/TD Audi 100 2.4TD SKODA</p>	<p>18-7050760 STD -mm 18-7050763 0,50 mm</p> 	<p>A = 41,700 B = 71,700 C = 1,600</p> <p>Ring Carrier Steel Support</p>	<p>RE56110000 -STD RE56110050 -0,50 RE56110100 -1,00</p> <p>1,750 (500) CrB Fe S 2,000 (501) Cr IFU 3,000 (604) Cr</p>	<p>ø24,0 x 64,0</p>			<p>1. Notch 1.40 mm Gasket + 0,67 + 0,80</p> <p>2. Notch 1.50 mm Gasket + 0,81 + 0,90</p> <p>3. Notch 1.60 mm Gasket + 0,91 + 1,02</p>
<p>ø76,51</p> <p>4 Cyl. Gasoline 1598 cc 77 Kw (105 Ps) BCB</p> <p><u>2001 - 2006</u></p> <p>Bora Golf (2001 - 2006)</p>	<p>18-7010520 STD -mm 18-7010523 0,50 mm</p> 	<p>A = 29,270 B = 50,270 C = 2,800 E = -1,400 F = -2,350</p>	<p>RE56310000 -STD RE56310050 -0,50</p> <p>1,200 (500) NitB S IF 1,500 (508) P 2,500 (700) Cr P S</p>	<p>ø17,0 x 52,0</p>			

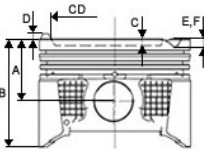







Engine	Ref. No. - Kit 1	Dimensions	Rings	Pin	Piston Liner	Kit 2	Info
<p>ø76,51</p> <p>4 Cyl. Diesel 1588 cc 59 Kw (80 Ps) 23:1 RA SBDE <u>1989 - 1993</u></p> <p><i>Golf Jetta Passat 1989 - 1993</i></p>	<p>18-7081140 STD -mm 18-7081143 0,50 mm 18-7081148 1,00 mm</p>	<p>A = 41,700 B = 71,700 C = 1,600</p> <p>Ring Carrier Hard Anodising Steel Support Oil Cut-Out</p>	<p>RE56100000 -STD RE56100050 -0,50 RE56100100 -1,00</p> <p>1,750 (500) CrB Fe S 2,000 (501) P IFU 3,000 (604) Cr</p>	<p>ø24,0 x 64,0</p>			<p>1.Notch 1.53 mm Gasket +0,66 +0,80</p> <p>2.Notch 1.57 mm Gasket +0,81 +0,90</p> <p>3.Notch 1.61 mm Gasket +0,91 +1,02</p>
<p>ø79,50</p> <p>R 4 Petrol, 1588 cm³ 58 kW (79 hp), 8,2:1 EE EF EJ FN FR WV WVA YG YH YN YP YV <u>1974 - 1983</u></p> <p><i>Audi (80 1.6-100 1.6) VW Golf I 1.6</i></p>	<p>14-7010070 STD -mm 14-7010073 0,50 mm</p> 	<p>A = 41,800 B = 73,800 C = 6,100 CD= 65,100</p>	<p>RE56150000 -STD RE56150050 -0,50 RE56150100 -1,00</p> <p>1,750 (500) CrB Fe S IF 2,000 (508) P 4,000 (700) Cr P S</p>	<p>ø22,0 x 55,0</p>			



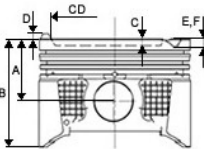



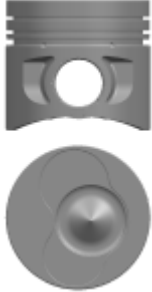
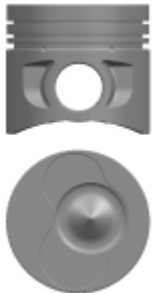

Engine	Ref. No. - Kit 1	Dimensions	Rings	Pin	Piston Liner	Kit 2	Info
<p>ø79,50</p> <p>R 4 Petrol, 1588 cm³ 81 kW (110 hp), 9,5:1 EG</p> <p><u>1976 - 1980</u></p> <p><i>Golf Gti Cabriolet Scirocco Gti Passat Gti Jetta Gti</i></p>	<p>14-7010100 STD -mm 14-7010103 0,50 mm</p>	<p>A = 40,700 B = 72,700 C = 8,300</p>	<p>RE56150000 -STD RE56150050 -0,50 RE56150100 -1,00</p> <p>1,750 (500) CrB Fe S IF 2,000 (508) P 4,000 (700) Cr P S</p>	<p>ø22,0 x 63,0</p>			
<p>ø79,50</p> <p>3 Cyl. Diesel 1422 cc 55 Kw (75 Ps) 19.5:1 AMF BAY BWB BHC BNV</p> <p><u>1999 -....</u></p> <p><i>1. & 2. Sil. Polo 1,4 Tdi Lupo 1,4 Tdi Fox 1,4 Tdi Fabiá 1.4 TDi</i></p>	<p>18-7050880 STD -mm 18-7050883 0,50 mm</p>	<p>A = 45,800 B = 69,800 C = 17,650 E = -1,100 CD= 37,900</p> <p>Ring Carrier Oil Cut-Out Bushing</p>	<p>RE56160000 -STD RE56160050 -0,50 RE56160100 -1,00</p> <p>1,750 (500) CrB Fe S 2,000 (501) P IFU 3,000 (604) Cr P S</p>	<p>ø26,0 x 63,0</p>			<p>1,53 mm Gasket + 0,81 + 0,96</p> <p>1,57 mm Gasket + 0,96 + 1,01</p> <p>1,61 mm Gasket + 1,01 + 1,03</p>

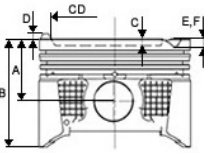

							
Engine	Ref. No. - Kit 1	Dimensions	Rings	Pin	Piston Liner	Kit 2	Info
<p>ø79,50</p> <p>3 Cyl. Diesel 1422 cc 55 Kw (75 Ps) 19.5: AMF <u>1999 -....</u></p> <p><u>3. Sil.</u> Polo 1,4 Tdi Lupo 1,4 Tdi Fox 1,4 Tdi Fabia 1.4 TDi</p>	<p>18-7050890 STD -mm 18-7050893 0,50 mm</p>	<p>A = 45,800 B = 69,800 C = 17,650 E = -1,100 CD= 37,900</p> <p>Ring Carrier Oil Cut-Out Bushing</p>	<p>RE56160000 -STD RE56160050 -0,50 RE56160100 -1,00</p> <p>1,750 (500) CrB Fe S 2,000 (501) P IFU 3,000 (604) Cr P S</p>	<p>ø26,0 x 63,0</p>			<p>1,53 mm Gasket + 0,81 + 0,96</p> <p>1,57 mm Gasket + 0,96 + 1,01</p> <p>1,61 mm Gasket + 1,01 + 1,03</p>
<p>ø79,50</p> <p>4/5 Cyl. Diesel 1896 cc 44 Kw (60 Ps) 22.5:1 ADG AEF BGG 1 X 1 Y(4 CY) AAB AJA (5 CYL) <u>1990 - 1995</u></p> <p>Golf Polo Passat Caddy Transporter T4 Audi 80 1.9D Audi 100 2.4D Skoda Felicia 1.9D</p>	<p>18-7050920 STD -mm 18-7050923 0,50 mm 18-7050928 1,00 mm</p>	<p>A = 39,650 B = 65,700 C = 1,900</p> <p>Ring Carrier Steel Support Oil Cut-Out</p>	<p>RE56160000 -STD RE56160050 -0,50 RE56160100 -1,00</p> <p>1,750 (500) CrB Fe S 2,000 (501) P IFU 3,000 (604) Cr P S</p>	<p>ø24,0 x 64,0</p>			<p>1. Notch 1.53 mm Gasket + 0,66 + 0,86</p> <p>2. Notch 1.57 mm Gasket + 0,87 + 0,90</p> <p>3. Notch 1.61 mm Gasket + 0,91 + 1,02</p>

Engine	Ref. No. - Kit 1	Dimensions	Rings	Pin	Piston Liner	Kit 2	Info
<p>ø79,50</p> <p>R 4 Diesel, 1716 cm³ 42 kW (57 hp), 23:1 KY <u>1986 - 1992</u> Transporter T3</p>	<p>14-7050930 STD -mm 14-7050933 0,50 mm 14-7050938 1,00 mm</p>	<p>A = 41,700 B = 67,700 C = 1,600</p> <p>Ring Carrier</p>	<p>RE56330000 -STD RE56330050 -0,50 RE56330100 -1,00</p> <p>1,750 (500) CrB Fe S 2,000 (501) Cr P IFU 3,000 (604) Cr P S</p>	<p>ø24,0 x 64,0</p>			
<p>ø79,50</p> <p>4 Cyl. Diesel 1896 cc 50 Kw (68 Ps) 22.5:1 AAZ ABL ADE <u>1992 -....</u> Transporter T4 Passat 1.9 TD Golf III 1.9 TD Vento 1.9 TD Audi 80 1.9 TD</p>	<p>18-7050940 STD -mm 18-7050943 0,50 mm 18-7050948 1,00 mm</p>	<p>A = 45,650 B = 71,700 C = 1,900</p> <p>Ring Carrier Hard Anodising Steel Support Oil Cut-Out</p>	<p>RE56330000 -STD RE56330050 -0,50 RE56330100 -1,00</p> <p>1,750 (500) CrB Fe S 2,000 (501) Cr P IFU 3,000 (604) Cr P S</p>	<p>ø26,0 x 66,0</p>			<p>1. Notch 1.53 mm Gasket +0,66 +0,86</p> <p>2. Notch 1.57 mm Gasket +0,87 +0,90</p> <p>3. Notch 1.61 mm Gasket +0,91 +1,02</p>

							
Engine	Ref. No. - Kit 1	Dimensions	Rings	Pin	Piston Liner	Kit 2	Info
<p>ø79,50</p> <p>4 Cyl. Diesel 1896 cc 66 Kw (90 Ps) 19.5:1 1Z AGD AEY AHH AHU AFN AHF <u>1993 - 1997</u></p> <p>1. & 2. Sil. Vento 1.9 Tdi Passat 1.9 Tdi Bora 1.9 Tdi Golf III 1.9 Tdi A3 I 1.9 Tdi A4 1.9 Tdi A6 1.9 Tdi Cabriolet 1.9 Tdi Audi 80 1.9 Tdi Skoda Sperrb Tdi Skoda Octavia Tdi</p> 	<p>18-7050950 STD -mm 18-7050953 0,50 mm</p>	<p>A = 45,800 B = 71,800 C = 17,650 E = -1,100 CD= 37,900</p> <p>Ring Carrier Oil Cut-Out Bushing</p>	<p>RE56160000 -STD RE56160050 -0,50 RE56160100 -1,00</p> <p>1,750 (500) CrB Fe S 2,000 (501) P IFU 3,000 (604) Cr P S</p>	<p>ø26,0 x 66,0</p>			<p>1. Notch 1.45 mm Gasket + 0,91 + 1,00</p> <p>2. Notch 1.53 mm Gasket + 1,00 + 1,10</p> <p>3. Notch 1.61 mm Gasket + 1,10 + 1,20</p>
<p>ø79,51</p> <p>4 Cyl. Diesel 1896 cc 66 Kw (90 Ps) 19.5:1 1Z AGD AEY AHH AHU AFN AHF <u>1993 - 1997</u></p> <p>3. & 4. Sil. Vento 1.9 Tdi Passat 1.9 Tdi Bora 1.9 Tdi Golf III 1.9 Tdi A3 I 1.9 Tdi A4 1.9 Tdi A6 1.9 Tdi Cabriolet 1.9 Tdi Audi 80 1.9 Tdi Skoda Sperrb Tdi Skoda Octavia Tdi</p> 	<p>18-7050960 STD -mm 18-7050963 0,50 mm</p>	<p>A = 45,800 B = 71,800 C = 17,650 E = -1,100 CD= 37,900</p> <p>Ring Carrier Oil Cut-Out Bushing</p>	<p>RE56160000 -STD RE56160050 -0,50 RE56160100 -1,00</p> <p>1,750 (500) CrB Fe S 2,000 (501) P IFU 3,000 (604) Cr P S</p>	<p>ø26,0 x 66,0</p>			<p>1. Notch 1.45 mm Gasket + 0,91 + 1,00</p> <p>2. Notch 1.53 mm Gasket + 1,00 + 1,10</p> <p>3. Notch 1.61 mm Gasket + 1,10 + 1,20</p>

							
Engine	Ref. No. - Kit 1	Dimensions	Rings	Pin	Piston Liner	Kit 2	Info
<p>ø79,50</p> <p>4 Cyl. Diesel 1896 cc 47 Kw (64 Ps) 50 Kw (68 Ps) 19,5:1 ASX (1999>) AQM (1997>) AGP (1997>) ASY/AYQ (2001>) 1997 -.....</p> <p><i>1. & 2. Sil</i> Polo SDI Bora SDI Golf SDI</p>	<p>14-7050970 STD -mm 14-7050973 0,50 mm</p>	<p>A = 39,800 B = 60,700 C = 17,750 E = -1,000 CD= 38,000</p>	<p>RE56160000 -STD RE56160050 -0,50 RE56160100 -1,00</p> <p>1,750 (500) CrB Fe S 2,000 (501) P IFU 3,000 (604) Cr P S</p>	<p>ø24,0 x 59,0</p>			
<p>ø79,50</p> <p>4 Cyl. Diesel 1896 cc 47 Kw (64 Ps) 50 Kw (68 Ps) 19,5:1 ASX (1999>) AQM (1997>) AGP (1997>) ASY/AYQ (2001>) 1997 -.....</p> <p><i>3. & 4. Sil</i> Polo SDI Bora SDI Golf SDI</p>	<p>14-7050980 STD -mm 14-7050983 0,50 mm</p>	<p>A = 39,800 B = 60,700 C = 17,750 E = -1,000 CD= 38,000</p>	<p>RE56160000 -STD RE56160050 -0,50 RE56160100 -1,00</p> <p>1,750 (500) CrB Fe S 2,000 (501) P IFU 3,000 (604) Cr P S</p>	<p>ø24,0 x 59,0</p>			

Engine	Ref. No. - Kit 1	Dimensions	Rings	Pin	Piston Liner	Kit 2	Info
<p>ø79,50</p> <p>4 Cyl. Diesel 1598cc 77KW 105HP CLHA CLHB CRKB <u>2010 -.....</u></p> <p>A3 1.6 TDI 16V GOLF VII 1.6 TDI Leon 1.6 TDI Octavia 1.6 TDI 2010 -</p>	<p>18-7092090 STD -mm 18-7092093 0,50 mm</p>	<p>A = 45,300 B = 68,130 CD= 49,000</p> <p>Ring Carrier Oil Gallery Oil Cut-Out</p>	<p>RE56140000 -STD RE56140050 -0,50</p> <p>1,750 (500) Cr P 2,000 (501) P IF 2,000 (604) Nit S</p>	<p>ø26,0 x 66,0</p>			
<p>ø79,51</p> <p>4 Cyl. Diesel 1896 cc 66 Kw (90 Ps) 19.5:1 1Z AGD AEY AHH AHU AFN AHF <u>1993 - 1997</u></p> <p>3. & 4. Sil. Vento 1,9 Tdi Passat 1,9 Tdi Bora 1,9 Tdi Golf III 1,9 Tdi A3 I 1,9 Tdi A4 1,9 Tdi A6 1,9 Tdi Cabriolet 1,9 Tdi Audi 80 1,9 Tdi Skoda Sporb Tdi Skoda Octavia Tdi</p>	<p>18-7050960 STD -mm 18-7050963 0,50 mm</p>	<p>A = 45,800 B = 71,800 C = 17,650 E = -1,100 CD= 37,900</p> <p>Ring Carrier Oil Cut-Out Bushing</p>	<p>RE56160000 -STD RE56160050 -0,50 RE56160100 -1,00</p> <p>1,750 (500) CrB Fe S 2,000 (501) P IFU 3,000 (604) Cr P S</p>	<p>ø26,0 x 66,0</p>			<p>1. Notch 1.45 mm Gasket + 0,91 + 1,00</p> <p>2. Notch 1.53 mm Gasket + 1,00 + 1,10</p> <p>3. Notch 1.61 mm Gasket + 1,10 + 1,20</p>

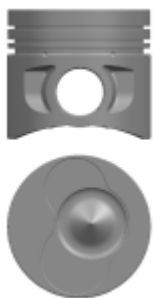

Engine	Ref. No. - Kit 1	Dimensions	Rings	Pin	Piston Liner	Kit 2	Info
<p>ø79,51</p> <p>3/4 Cyl. Diesel 1598cc 55 Kw 75 ps CFWA CAYA <u>2009 -.....</u></p> <p><i>Polo 1.2 Tdi (3 cyl) Polo 1.6 TDI 16V 4 cyl 2009 - 2014</i></p>	<p>18-7092500 STD -mm 18-7092503 0,50 mm</p>	<p>A = 45,300 B = 67,900 C = 10,700 CD= 49,000</p> <p>Ring Carrier Oil Gallery</p>	<p>RE56160000 -STD RE56160050 -0,50 RE56160100 -1,00</p> <p>1,750 (500) CrB Fe S 2,000 (501) P IFU 3,000 (604) Cr P S</p>	<p>ø26,0 x 66,0</p>			
<p>ø79,51</p> <p>4 Cyl. Diesel 1896 cc 74 Kw (101 Ps) AVQ ATD AXR AVB BJB SERISI OIL GALERY VAR <u>2004 -.....</u></p> <p><i>1.ve 2. Sil. Caddy III TDI Touran TDI Bora TDI Golf TDI Polo TDI Passat TDI</i></p>	<p>18-7092750 STD -mm 18-7092753 0,50 mm</p>	<p>A = 45,800 B = 68,800 C = 17,100 E = -0,650 CD= 38,000</p> <p>Ring Carrier Oil Gallery Oil Cut-Out Bushing</p>	<p>RE56330000 -STD RE56330050 -0,50 RE56330100 -1,00</p> <p>1,750 (500) CrB Fe S 2,000 (501) Cr P IFU 3,000 (604) Cr P S</p>	<p>ø25,0 x 69,8</p>			<p>1,45 mm Gasket +0,91 +1,00</p> <p>1,53 mm Gasket +1,01 +1,10</p> <p>1,61 mm Gasket +1,11 +1,20</p>

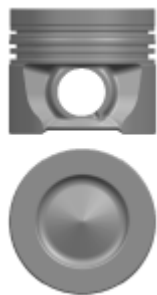



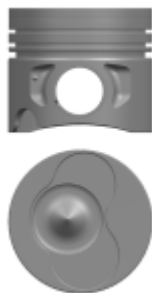







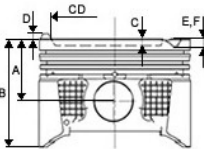





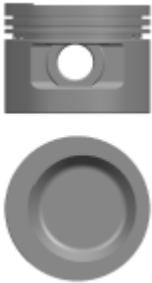
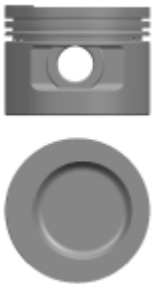

Engine	Ref. No. - Kit 1	Dimensions	Rings	Pin	Piston Liner	Kit 2	Info
<p>ø79,51</p> <p>4 Cyl. Diesel 1896 cc 74 Kw (101 Ps) AVQ ATD AXR AVB BJB SERISI OIL GALERY VAR</p> <p><u>2004 -....</u></p> <p>3.ve 4. Sil. Caddy III TDI Touran TDI Bora TDI Golf TDI Polo TDI Passat TDI</p>	<p>18-7092760 STD -mm 18-7092763 0,50 mm</p>	<p>A = 45,800 B = 68,800 C = 17,100 E = -0,650 CD= 38,000</p> <p>Ring Carrier Oil Gallery Oil Cut-Out Bushing</p>	<p>RE56330000 -STD RE56330050 -0,50 RE56330100 -1,00</p> <p>1,750 (500) CrB Fe S 2,000 (501) Cr P IFU 3,000 (604) Cr P S</p>	<p>ø26,0 x 66,0</p>			<p>1,45 mm Gasket +0,91 +1,00</p> <p>1,53 mm Gasket +1,01 +1,10</p> <p>1,61 mm Gasket +1,11 +1,20</p>
<p>ø79,51</p> <p>4 Cyl. Diesel 1896 cc 110 Kw (150 Ps) ARL ASZ AXB AXC AXB EUR3</p> <p><u>2000 -....</u></p> <p>1. & 2. Sil. Bora PDI Golf PDI Bora TDI Golf TDI Multi Van Transporter Transporter TDI</p>	<p>18-7092770 STD -mm 18-7092773 0,50 mm</p>	<p>A = 45,800 B = 68,800 C = 17,900 E = -1,100 CD= 38,000</p> <p>Ring Carrier Oil Gallery Oil Cut-Out Bushing</p>	<p>RE56160000 -STD RE56160050 -0,50 RE56160100 -1,00</p> <p>1,750 (500) CrB Fe S 2,000 (501) P IFU 3,000 (604) Cr P S</p>	<p>ø26,0 x 66,0</p>			<p>1,45 mm Gasket +0,91 +1,00</p> <p>1,53 mm Gasket +1,01 +1,10</p> <p>1,61 mm Gasket +1,11 +1,20</p>

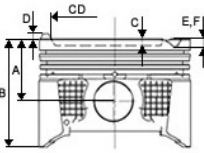





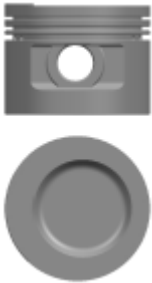





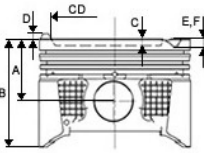





Engine	Ref. No. - Kit 1	Dimensions	Rings	Pin	Piston Liner	Kit 2	Info
<p>ø79,51</p> <p>4 Cyl. Diesel 1896 cc 110 Kw (150 Ps) ARL ASZ AXB AXC AXB EUR3 <u>2000 -....</u></p> <p><i>3. & 4. Sil. Borg PDI Golf PDI Borg TDI Golf TDI Multi Van Transporter Transporter TDI</i></p>	<p>18-7092780 STD -mm 18-7092783 0,50 mm</p>	<p>A = 45,800 B = 68,800 C = 17,900 E = -1,100 CD= 38,000</p> <p>Ring Carrier Oil Gallery Oil Cut-Out Bushing</p>	<p>RE56160000 -STD RE56160050 -0,50 RE56160100 -1,00</p> <p>1,750 (500) CrB Fe S 2,000 (501) P IFU 3,000 (604) Cr P S</p>	<p>ø26,0 x 66,0</p>			
<p>ø81,00</p> <p>R 4 Petrol, 1595 cm³ 53/55 kW (72/75 hp) ABN DT EW EZ ABX ACR DTA EZA HM <u>1991 -....</u></p> <p><i>Golf Jetta Passat Audi 80 1.6</i></p>	<p>14-7010160 STD -mm 14-7010163 0,50 mm</p>	<p>A = 35,600 B = 58,500 C = 2,300 D = 0,700</p>	<p>RE56180000 -STD RE56180050 -0,50 RE56180100 -1,00</p> <p>1,500 (500) CrB S IF 1,750 (508) P 3,000 (700) Cr P S</p>	<p>ø20,0 x 57,0</p>			

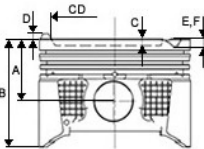

							
Engine	Ref. No. - Kit 1	Dimensions	Rings	Pin	Piston Liner	Kit 2	Info
<p>ø81,00</p> <p>R 4 Petrol, 1781 cm³ 55 kW (75 hp) AMM ANN ACC ADD RP</p> <p><u>1983 - 1996</u></p> <p><i>Golf I 1,8 Jetta II 1,8 Passat 1,8 Audi 80 1,8 Audi 80 1,8 cc Audi 80 1,8 s Audi 100 1,8 Audi Coupe 1,8 Audi Coupe 1,8 GT</i></p> 	<p>18-7010170 STD -mm 18-7010173 0,50 mm</p>	<p>A = 32,200 B = 62,500 C = 8,100 D = 1,300 CD= 56,800</p>	<p>RE56190000 -STD RE56190050 -0,50</p> <p>1,500 (500) CrB S IF 1,750 (508) P 3,000 (604) Cr</p>	<p>ø20,0 x 57,0</p>			
<p>ø81,00</p> <p>R 5 Petrol, 2226 cm³ 101 kW (137 hp), 10:1 HY KV JT KX KM</p> <p><u>1984 - 1990</u></p> <p><i>Passat</i></p> 	<p>14-7010200 STD -mm</p>	<p>A = 32,200 B = 62,300 C = 4,600 D = 1,100 CD= 60,000</p> <p>Steel Support</p>	<p>RE56180000 -STD RE56180050 -0,50 RE56180100 -1,00</p> <p>1,500 (500) CrB S IF 1,750 (508) P 3,000 (700) Cr P S</p>	<p>ø20,0 x 57,0</p>			

							
Engine	Ref. No. - Kit 1	Dimensions	Rings	Pin	Piston Liner	Kit 2	Info
<p>ø81,00</p> <p>4 Cyl. Gasoline 1781 cc 72 Kw (98 Ps) ABS ADZ DS DX DZ EV GZ HT</p> <p><u>1988 - 1991</u></p> <p><i>Golf I 1,8i Jetta II 1,8 Passat 1,8 Audi 80 1.8 Audi 100 1.8 Quattro Coupe 1.8 GT</i></p> 	<p>18-7010210 STD -mm 18-7010213 0,50 mm</p>	<p>A = 32,200 B = 62,500 C = 5,700 D = 1,300 CD= 55,700</p> <p>Steel Support</p>	<p>RE56190000 -STD RE56190050 -0,50</p> <p>1,500 (500) CrB S IF 1,750 (508) P 3,000 (604) Cr</p>	<p>ø20,0 x 57,0</p>			
<p>ø81,00</p> <p>4 Cyl. Gasoline 1781 cc 110 Kw (150 Ps) AEB AGU AJH ANB APH APU AQA ARZ AVC</p> <p><u>1996 -....</u></p> <p><i>Golf VI 1,8 t Bora 1,8 t Passat 1,8 t Audi A3 I 1,8 T Audi A4 1,8 T Audi A6 1,8 T Audi TT 1,8 T Skoda Octavia Turbo</i></p> 	<p>18-7010220 STD -mm 18-7010221 0,25 mm 18-7010223 0,50 mm</p>	<p>A = 32,700 B = 53,700 C = 1,500 CD= 70,200</p>	<p>RE56380000 -STD RE56380025 -0,25 RE56380050 -0,50 RE56380100 -1,00</p> <p>1,500 (500) CrBFeSIF 1,750 (508) P 2,000 (700) Nits</p>	<p>ø20,0 x 59,0</p>			

							
Engine	Ref. No. - Kit 1	Dimensions	Rings	Pin	Piston Liner	Kit 2	Info
<p>ø81,00</p> <p>4 Cyl. Gasoline 1781 cc 92 Kw (125 Ps) AGN APT ARG <u>1996 -....</u></p> <p><i>Golf VI 1,8 Bora 1,8 Passat 1,8 Audi A3 1,8 l Audi A4 1,8 Audi A6 1,8 Audi Cabriolet 1,8 l Skoda Octavia 20v</i></p>	<p>18-7010230 STD -mm 18-7010233 0,50 mm</p>	<p>A = 32,550 B = 56,550 E = -3,300</p> <p>Oil Cut-Out</p>	<p>RE56380000 -STD RE56380025 -0,25 RE56380050 -0,50 RE56380100 -1,00</p> <p>1,500 (500) CrBFeSIF 1,750 (508) P 2,000 (700) NitS</p>	<p>ø20,0 x 59,0</p>			
<p>ø81,00</p> <p>4 Cyl. Gasoline 1781cc 110 Kw (150 Hp) ARX AUM AUQ AWM AWP AWT AWU AWV BJX BKF BNU AWP BE <u>2000 - 2001</u></p> <p><i>Leon Toledo Ibiza Octavia Bora Golf IV Passat Jetta New Beetle</i></p>	<p>18-7010250 STD -mm 18-7010253 0,50 mm</p>	<p>A = 32,700 B = 53,700 C = 32,700 D = 69,200 E = -1,900 CD= 1,900</p> <p>Hard Anodising Oil Cut-Out</p>	<p>RE56380000 -STD RE56380025 -0,25 RE56380050 -0,50 RE56380100 -1,00</p> <p>1,500 (500) CrBFeSIF 1,750 (508) P 2,000 (700) NitS</p>	<p>ø19,0 x 50,0</p>			

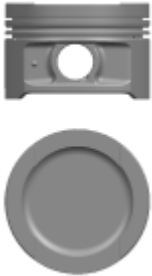
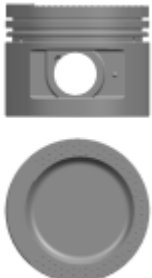
							
Engine	Ref. No. - Kit 1	Dimensions	Rings	Pin	Piston Liner	Kit 2	Info
<p>ø81,00</p> <p>4 Cyl. Gasoline 1595 cc 75 Kw (102 Ps) ADP AEH AEK AFT AHL AKL</p> <p><u>1996 - 1997</u></p> <p><i>Golf VI 1,6 Golf III 1,6 Passat 1,6 Vento 1,6 Audi A3cl 1,6 l Audi A4 1,6 Skoda Octavia</i></p> 	<p>18-7010350 STD -mm 18-7010353 0,50 mm</p>	<p>A = 32,000 B = 53,700 C = 3,000 E = -0,700 CD= 62,500</p>	<p>RE56370000 -STD RE56370050 -0,50 RE56370100 -1,00</p> <p>1,200 (500) NitB S IF 1,500 (508) P 2,000 (700) Nit S</p>	<p>ø20,0 x 57,0</p>			
<p>ø81,00</p> <p>R 5 Petrol, 2459 cm³ 85 kW (115 hp) ACU AVT APL AET</p> <p><u>1996 - 2003</u></p> <p><i>Transporter T4 2,5</i></p> 	<p>14-7010800 STD -mm 14-7010803 0,50 mm</p>	<p>A = 38,350 B = 64,350 C = 4,600 CD= 62,000</p>	<p>RE56180000 -STD RE56180050 -0,50 RE56180100 -1,00</p> <p>1,500 (500) CrB S IF 1,750 (508) P 3,000 (700) Cr P S</p>	<p>ø24,0 x 56,0</p>			







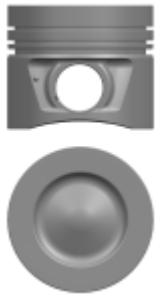

Engine	Ref. No. - Kit 1	Dimensions	Rings	Pin	Piston Liner	Kit 2	Info
<p>ø81,00</p> <p>R 4 Petrol, 1998 cm³ 62 kW (84 hp), 8,5:1 AAC AAF AEU <u>1990 -....</u></p> <p><i>Transporter T4 2,0 Transporter T4 2,5</i></p>	<p>14-7010810 STD -mm 14-7010813 0,50 mm</p>	<p>A = 38,500 B = 65,450 C = 10,500 D = 1,100 CD= 62,000</p>	<p>RE56170000 -STD RE56170050 -0,50 RE56170100 -1,00</p> <p>1,750 (500) CrB Fe S IF 2,000 (508) P 3,000 (700) Cr P S</p>	<p>ø24,0 x 56,0</p>			
<p>ø81,00</p> <p>5 Cyl. Diesel 2459 cc 55 Kw (75 Ps) AGX ANF AJT APA AYY BBE ACV AHD AUF AXL <u>1996 - 2001</u></p> <p><i>1. & 2. Sil. T4 Tdi LT 35 Tdi LT 28 Tdi Caravelle CL/GL Caravelle Club, Caravelle Variant Trans porter</i></p>	<p>18-7050840 STD -mm 18-7050843 0,50 mm</p>	<p>A = 45,750 B = 69,750 C = 17,200 E = -1,400 CD= 39,700</p> <p>Ring Carrier Hard Anodising Oil Cut-Out Bushing</p>	<p>RE56410000 -STD RE56410050 -0,50 RE56410100 -1,00</p> <p>2,500 (500) Cr P 2,000 (501) P 3,000 (604) Cr P</p>	<p>ø26,0 x 68,0</p>			<p>1. Notch 1.53 mm Gasket +0,80 +0,90</p> <p>2. Notch 1.57 mm Gasket +0,90 +1,00</p> <p>3. Notch 1.61 mm Gasket +1,00 +1,10</p>



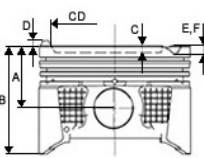









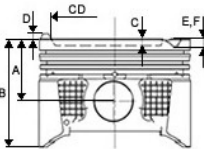





Engine	Ref. No. - Kit 1	Dimensions	Rings	Pin	Piston Liner	Kit 2	Info
<p>ø81,00</p> <p>5 Cyl. Diesel 2459 cc 55 Kw (75 Ps) AGX ANF AJT APA AYY BBE ACV AHD AUF AXL</p> <p><u>1996 - 2001</u></p> <p><i>3.4. & Sil. 1.4 Tdi 1T 35 Tdi 1T 28 Tdi Caravelle CL/GL Caravelle Club Caravelle Variant Trans porter</i></p> 	<p>18-7050850 STD -mm 18-7050853 0,50 mm</p>	<p>A = 45,750 B = 69,750 C = 17,200 E = -1,400 CD= 39,700</p> <p>Ring Carrier Hard Anodising Oil Cut-Out Bushing</p>	<p>RE56410000 -STD RE56410050 -0,50 RE56410100 -1,00</p> <p>2,500 (500) Cr P 2,000 (501) P 3,000 (604) Cr P</p>	<p>ø26,0 x 68,0</p>			<p>1.Notch 1.53 mm Gasket +0,80 +0,90</p> <p>2.Notch 1.57 mm Gasket +0,90 +1,00</p> <p>3.Notch 1.61 mm Gasket +1,00 +1,10</p>
<p>ø81,00</p> <p>4 Cyl. Diesel 2459cc 105 Kw (145 Ps) AZV CBAA CFFA</p> <p><u>2007 -....</u></p> <p><i>A3 II 2.0 TDI CRAFTER 2.0 TDI Q5 2005-2012...</i></p>	<p>18-7094250 STD -mm 18-7094253 0,50 mm</p>	<p>A = 45,800 B = 68,800 C = 12,700 CD= 50,900</p> <p>Ring Carrier Oil Gallery Bushing</p>	<p>RE56400000 -STD RE56400025 -0,25 RE56400050 -0,50 RE56400100 -1,00</p> <p>1,750 (500) CrB Fe S IF 2,000 (508) P 3,000 (604) Cr P</p>	<p>ø26,0 x 66,0</p>			

Engine	Ref. No. - Kit 1	Dimensions	Rings	Pin	Piston Liner	Kit 2	Info
<p>ø81,00</p> <p>4 Cyl. Diesel 2000 cc 100 120 KW/136 163 HP CKTC CKUC CKUB CKTB <u>2010 -....</u> Crafter 2.0 TDI Amarok 2010 -</p>	<p>18-7094400 STD -mm 18-7094403 0,50 mm</p>	<p>A = 45,800 B = 68,800 C = 13,100 CD= 50,880</p> <p>Ring Carrier Oil Gallery Oil Cut-Out Bushing</p>	<p>RE56400000 -STD RE56400025 -0,25 RE56400050 -0,50 RE56400100 -1,00</p> <p>1,750 (500) CrB Fe S IF 2,000 (508) P 3,000 (604) Cr P</p>	<p>ø26,0 x 66,0</p>			
<p>ø81,00</p> <p>4 Cyl. Diesel 1968 cc 100 KW 136 PS 16,5:1 CFHB CFHC CFHE CFJA <u>2005 -....</u> Golf VI 2.0TDI Jetta IV 2.0TDI Caddy III 2.0TDI Touran 2.0TDI 2005 -</p>	<p>18-7094490 STD -mm 18-7094493 0,50 mm</p>	<p>A = 45,800 B = 68,800 C = 12,700 CD= 50,880</p> <p>Ring Carrier Oil Gallery Oil Cut-Out Bushing</p>	<p>RE56400000 -STD RE56400025 -0,25 RE56400050 -0,50 RE56400100 -1,00</p> <p>1,750 (500) CrB Fe S IF 2,000 (508) P 3,000 (604) Cr P</p>	<p>ø26,0 x 66,0</p>			

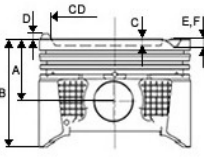









							
Engine	Ref. No. - Kit 1	Dimensions	Rings	Pin	Piston Liner	Kit 2	Info
<p>ø81,00</p> <p>4 Cyl. Diesel 1968 cc 100 103 KW/136 140 PS BGW BMM BMP BRT BSS <u>2003 -.....</u></p> <p><i>1. & 2. Sil. Caddy III BOX 2.0 TDI Golf VI 2.0 TDI Jetta III 2.0 TDI 2003 -</i></p>	<p>18-7094770 STD -mm 18-7094773 0,50 mm</p>	<p>A = 45,000 B = 68,800 C = 17,500 E = -0,700 CD= 38,000</p> <p>Ring Carrier Oil Gallery Oil Cut-Out Bushing</p>	<p>RE56400000 -STD RE56400025 -0,25 RE56400050 -0,50 RE56400100 -1,00</p> <p>1,750 (500) CrB Fe S IF 2,000 (508) P 3,000 (604) Cr P</p>	<p>ø26,0 x 66,0</p>			
<p>ø81,00</p> <p>4 Cyl. Diesel 1968 cc 100 103 KW/136 140 PS BGW BMM BMP BRT BSS <u>2003 -.....</u></p> <p><i>3. & 4. Sil. Caddy III BOX 2.0 TDI Golf VI 2.0 TDI Jetta III 2.0 TDI 2003 -</i></p>	<p>18-7094780 STD -mm 18-7094783 0,50 mm</p>	<p>A = 45,800 B = 68,800 C = 17,500 E = -0,700 CD= 38,000</p> <p>Ring Carrier Oil Gallery Oil Cut-Out Bushing</p>	<p>RE56400000 -STD RE56400025 -0,25 RE56400050 -0,50 RE56400100 -1,00</p> <p>1,750 (500) CrB Fe S IF 2,000 (508) P 3,000 (604) Cr P</p>	<p>ø26,0 x 66,0</p>			

							
Engine	Ref. No. - Kit 1	Dimensions	Rings	Pin	Piston Liner	Kit 2	Info
<p>ø81,01</p> <p>4 Cyl. Gasoline 1598 cc 75 Kw (102 Ps) BFQ ALZ AVU BSE BSF BGU <u>2002 - 2006</u> 1.6 GOLF PASSAT JETTA A3 LEON</p>	<p>18-7010240 STD -mm 18-7010243 0,50 mm</p>	<p>A = 29,780 B = 50,700 C = 2,700 D = 0,200 CD= 62,300</p>	<p>RE56440000 -STD RE56440050 -0,50 RE56440100 -1,00</p> <p>1,000 (500) NitB S 1,200 (508) P 2,000 (700) Nit S</p>	<p>ø19,0 x 42,0</p>			<p>+ 0,60 + 0,65</p>
<p>ø81,01</p> <p>4 Cyl. Diesel 1968 cc 69 Ps BDJ BDK BST <u>2004 -....</u> 1. & 2. Sil. Caddy 2.0 SDI</p>	<p>18-7050780 STD -mm 18-7050783 0,50 mm</p>	<p>A = 37,800 B = 58,800 C = 17,350 E = -0,700 CD= 38,000</p> <p>Ring Carrier</p>	<p>RE56400000 -STD RE56400025 -0,25 RE56400050 -0,50 RE56400100 -1,00</p> <p>1,750 (500) CrB Fe S IF 2,000 (508) P 3,000 (604) Cr P</p>	<p>ø22,0 x 60,0</p>			<p>1. Notch Gasket +0,91 +1,00</p> <p>2. Notch Gasket +1,01 +1,10</p> <p>3. Notch Gasket +1,11 +1,20</p>

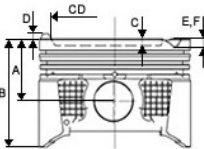







							
Engine	Ref. No. - Kit 1	Dimensions	Rings	Pin	Piston Liner	Kit 2	Info
<p>ø81,01</p> <p>4 Cyl. Diesel 1968 cc 69 Ps BDJ BDK BST <u>2004 -....</u> 3. & 4. Sil. Caddy 2.0 SDi</p>	<p>18-7050790 STD -mm 18-7050793 0,50 mm</p>	<p>A = 37,800 B = 58,800 C = 17,350 E = -0,700 CD= 38,000</p> <p>Ring Carrier</p>	<p>RE56400000 -STD RE56400025 -0,25 RE56400050 -0,50 RE56400100 -1,00</p> <p>1,750 (500) CrB Fe S IF 2,000 (508) P 3,000 (604) Cr P</p>	<p>ø22,0 x 60,0</p>			<p>1.Notch Gasket +0,91 +1,00</p> <p>2.Notch Gasket +1,01 +1,10</p> <p>3.Notch Gasket +1,11 +1,20</p>
<p>ø81,01</p> <p>R 5 Gasoline, 2459 cm³ 81 kW (110 hp) ACU AVT APL AET <u>1994 - 1996</u> Transporter T4 2.5</p>	<p>14-7050800 STD -mm</p>	<p>A = 38,350 B = 64,350 C = 4,600 CD= 62,000</p>	<p>RE56170000 -STD RE56170050 -0,50 RE56170100 -1,00</p> <p>1,750 (500) CrB Fe S IF 2,000 (508) P 3,000 (700) Cr P S</p>	<p>ø24,0 x 56,0</p>			



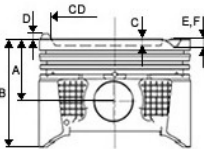



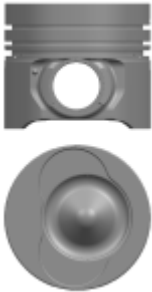

Engine	Ref. No. - Kit 1	Dimensions	Rings	Pin	Piston Liner	Kit 2	Info
<p>ø81,01</p> <p>5 Cyl. Diesel 2461 cc 80 Kw (109 Ps) 19.5: AVR BBR <u>2004 -....</u> A6 2.5TDI</p>	<p>18-7071770 STD -mm 18-7071773 0,50 mm</p>	<p>A = 45,800 B = 69,800 C = 16,800 E = -1,350 CD= 46,000</p> <p>Ring Carrier Oil Cut-Out Bushing</p>	<p>RE56410000 -STD RE56410050 -0,50 RE56410100 -1,00</p> <p>2,500 (500) Cr P 2,000 (501) P 3,000 (604) Cr P</p>	<p>ø26,0 x 68,0</p>			<p>0 +0,75</p> <p>1 Notch Gasket +0,87 +0,96</p> <p>2 Notch Gasket +0,97 +1,01</p> <p>3 Notch Gasket +1,02 +1,10</p>
<p>ø81,01</p> <p>5 Cyl. Diesel 2460 cc 96/128 Kw (130 Ps) AXD AXE BLJ Euro 3 BNZ <u>2004 -....</u> 1. & 2. Sil. Transporter T5</p>	<p>18-7092820 STD -mm 18-7092823 0,50 mm</p>	<p>A = 45,750 B = 69,750 C = 18,200 E = -1,400 CD= 37,800</p> <p>Ring Carrier Oil Gallery Oil Cut-Out Bushing</p>	<p>RE56410000 -STD RE56410050 -0,50 RE56410100 -1,00</p> <p>2,500 (500) Cr P 2,000 (501) P 3,000 (604) Cr P</p>	<p>ø26,0 x 66,0</p>			<p>1 Notch Gasket +0,80 +0,90</p> <p>2 Notch Gasket +0,90 +1,00</p> <p>3 Notch Gasket +1,00 +1,10</p>

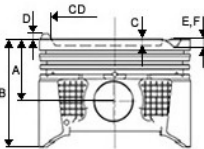

							
Engine	Ref. No. - Kit 1	Dimensions	Rings	Pin	Piston Liner	Kit 2	Info
<p>ø81,01</p> <p>5 Cyl. Diesel 2460 cc 96/128 Kw (130 Ps) AXD AXE BLJ Euro 3 BNZ <u>2004 -....</u> 3.4. & 5.Sil. Transporter T5</p>	<p>18-7092830 STD -mm 18-7092833 0,50 mm</p>	<p>A = 45,750 B = 69,750 C = 18,200 E = -1,400 CD= 37,800</p> <p>Ring Carrier Oil Gallery Oil Cut-Out Bushing</p>	<p>RE56410000 -STD RE56410050 -0,50 RE56410100 -1,00</p> <p>2,500 (500) Cr P 2,000 (501) P 3,000 (604) Cr P</p>	<p>ø26,0 x 66,0</p>			<p>1 Notch Gasket +0,80 +0,90</p> <p>2 Notch Gasket +0,90 +1,00</p> <p>3 Notch Gasket +1,00 +1,10</p>
<p>ø81,01</p> <p>4 Cyl. Diesel 2000 cc 140 Ps BKP BVE BMA BMN BMR BUZ BWV <u>2005 -....</u> Passat 2.0 TDI Jetta 2.0 TDI Golf V 2.0 TDI</p>	<p>18-7092840 STD -mm 18-7092843 0,50 mm</p>	<p>A = 45,800 B = 68,800 C = 17,800 CD= 38,000</p> <p>Ring Carrier Oil Gallery Oil Cut-Out Bushing</p>	<p>RE56400000 -STD RE56400025 -0,25 RE56400050 -0,50 RE56400100 -1,00</p> <p>1,750 (500) CrB Fe S IF 2,000 (508) P 3,000 (604) Cr P</p>	<p>ø26,0 x 66,0</p>			







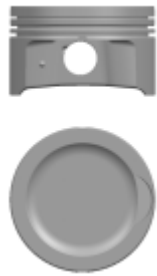





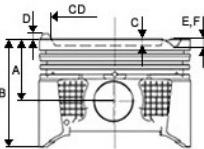





							
Engine	Ref. No. - Kit 1	Dimensions	Rings	Pin	Piston Liner	Kit 2	Info
<p>ø81,01</p> <p>5 Cyl. Diesel 2459cc 100 Kw (136 Ps) BJM CECB BJL Euro4 BJM Euro4 CECA Euro5 <u>2006 -.....</u></p> <p>LT 28 LT 35 LT 46 Crofter-LT 28 D LT 35 D LT 46 D</p> 	<p>18-7092850 STD -mm 18-7092853 0,50 mm</p>	<p>A = 45,750 B = 69,750 C = 16,600 E = -1,350 CD= 45,900</p> <p>Ring Carrier Oil Gallery Oil Cut-Out Bushing</p>	<p>RE56410000 -STD RE56410050 -0,50 RE56410100 -1,00</p> <p>2,500 (500) Cr P 2,000 (501) P 3,000 (604) Cr P</p>	<p>ø26,0 x 66,0</p>			
<p>ø81,01</p> <p>4 Cyl. Diesel 1968 cc 89 120KW/121 170 HP BKD BLB BNA BMN</p> <p><u>2003 -.....</u></p> <p>GOLF V 2.0 TDI JETTA III 2.0 TDI TOURAN 2.0 TDI 2003 -</p>	<p>18-7094670 STD -mm 18-7094673 0,50 mm</p>	<p>A = 48,800 B = 69,800 C = 17,800 CD= 38,000</p> <p>Ring Carrier Oil Gallery Oil Cut-Out Bushing</p>	<p>RE56400000 -STD RE56400025 -0,25 RE56400050 -0,50 RE56400100 -1,00</p> <p>1,750 (500) CrB Fe S IF 2,000 (508) P 3,000 (604) Cr P</p>	<p>ø26,0 x 66,0</p>			

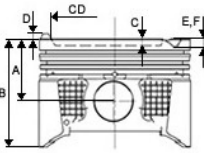

							
Engine	Ref. No. - Kit 1	Dimensions	Rings	Pin	Piston Liner	Kit 2	Info
<p>ø82,50</p> <p>4 Cyl. Gasoline 1781cc/1791cc 88/118/125kw 120/160170ps BZB BYT CABA CABB CABD</p> <p><u>2006 - 2008</u></p> <p>A3 1.8 TFSI 16V</p>	<p>18-7010400 STD -mm 18-7010403 0,50 mm</p>	<p>A = 29,800 B = 55,980 C = 4,750 D = 6,000 E = -2,000 CD= 67,000</p> <p>Ring Carrier</p>	<p>RE12160000 -STD RE12160025 -0,25 RE12160050 -0,50 RE12160100 -1,00</p> <p>1,200 (500) NitB S IF 1,500 (501) P 2,000 (700) Cr P S</p>	<p>ø21,0 x 53,0</p>			
<p>ø82,50</p> <p>4 Cyl. Gasoline 1984 cc 96 KW 131 PS ALT</p> <p><u>2000 -....</u></p> <p>Passat 2.0i 20V 2000 -</p>	<p>18-7010480 STD -mm 18-7010483 0,50 mm</p>	<p>A = 29,600 B = 50,600 C = 2,600 CD= 64,000</p>	<p>RE12160000 -STD RE12160025 -0,25 RE12160050 -0,50 RE12160100 -1,00</p> <p>1,200 (500) NitB S IF 1,500 (501) P 2,000 (700) Cr P S</p>	<p>ø19,0 x 44,0</p>			



Engine	Ref. No. - Kit 1	Dimensions	Rings	Pin	Piston Liner	Kit 2	Info
<p>ø82,50</p> <p>4 Cyl. Gasoline 1798cc 118 KW (160 Ps) CDAA CDAB CDHA CDHB <u>2010-....</u> Passat 1,8 FSI Golf VI</p>	<p>18-7050460 STD -mm 18-7050463 0,50 mm</p>	<p>A = 29,850 B = 50,350 C = 14,650 D = 5,650 E = -2,000</p> <p>Ring Carrier</p>	<p>RE56390000 -STD RE56390050 -0,50</p> <p>1,200 () 1,200 () 2,000 ()</p>	<p>ø23,0 x 51,0</p>			
<p>ø82,50</p> <p>4 Cyl. Gasoline 1984 cc 110 Kw (150 PS) BLR <u>2004-....</u> Golf 2.0 FSI 16V Jetta 2.0 FSI 16V Passat 2.0 FSI 16V 2004-</p>	<p>18-7051470 STD -mm 18-7051473 0,50 mm</p>	<p>A = 29,400 B = 47,400 C = 7,360 D = 12,460 E = -1,980</p> <p>Hard Anodising</p>	<p>RE56370000 -STD RE56370050 -0,50 RE56370100 -1,00</p> <p>1,200 (500) NitB S IF 1,500 (508) P 2,000 (700) Nit S</p>	<p>ø19,0 x 44,0</p>			

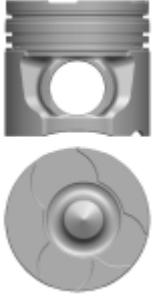

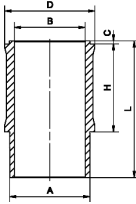



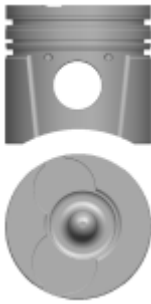
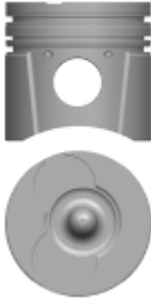

							
Engine	Ref. No. - Kit 1	Dimensions	Rings	Pin	Piston Liner	Kit 2	Info
<p>ø83,00</p> <p>6 Cyl. Diesel 2967cc 211/235/245 Ps BUN BUG BKS BSG BKN <u>2007 - 2015</u></p> <p>A6 3.0 TDI Q7 3.0 TDI 24V Touareg I 3.0 TDI 24V</p>	<p>18-7086880 STD -mm 18-7086883 0,50 mm</p>	<p>A = 46,300 B = 70,800 C = 15,100 CD= 45,000</p> <p>Ring Carrier Oil Gallery</p>	<p>RE12280000 -STD RE12280050 -0,50</p> <p>2,000 (500) Cr P 2,000 (501) Cr IFU 3,000 (604) Cr P</p>	<p>ø30,0 x 68,0</p>			
<p>ø93,00</p> <p>4 Cyl. Diesel 2798 cc 116 Kw (158 Ps) BCQ AUH ATA AGK <u>2002 -....</u></p> <p>LT28 D LT35 D LT46 D</p>	<p>18-7086760 STD -mm 18-7086763 0,50 mm</p>	<p>A = 56,200 B = 86,200 C = 18,500 E = -1,500 CD= 47,100</p> <p>Ring Carrier Hard Anodising Oil Cut-Out</p>	<p>RE56460000 -STD RE56460050 -0,50</p> <p>2,500 (504) Cr P 2,000 (501) P IWU 3,000 (604) Cr P</p>	<p>ø35,0 x 77,0</p>			

							
Engine	Ref. No. - Kit 1	Dimensions	Rings	Pin	Piston Liner	Kit 2	Info
<p>ø93,00</p> <p>4 Cyl. Diesel 2792 cc 116 Kw (158 Ps) AUH BCQ <u>2003 -.....</u></p> <p><i>LT28 D LT35 D LT46 D C.Rail</i></p>	<p>18-7086770 STD -mm 18-7086773 0,50 mm</p>	<p>A = 56,150 B = 87,150 C = 18,500 E = -1,500 CD= 47,100</p> <p>Ring Carrier Hard Anodising Oil Cut-Out</p>	<p>RE56460000 -STD RE56460050 -0,50</p> <p>2,500 (504) Cr P 2,000 (501) P IWU 3,000 (604) Cr P</p>	<p>ø35,0 x 77,0</p>			
							

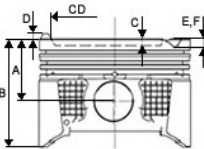





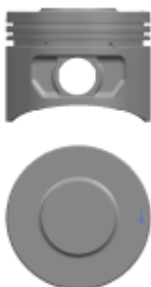
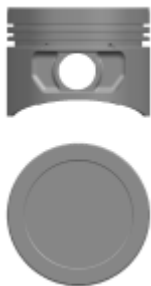

Engine	Ref. No. - Kit 1	Dimensions	Rings	Pin	Piston Liner	Kit 2	Info
<p>ø76,00</p> <p>4 Cyl. Gasoline 1397 cc 43 53 Kw (59 72 Ps) C1/2/3/16 J B14 B14 OE 847 700/720 847.2 715/717/742/768 <u>1981 - 1998</u> R18/5/19/21 R12 TSW/TX TOROS R9 BVA AUTOMOTIC R9 GTE BRODWAY/SPRING FUEGO RAPID EXPRESS TRAFFIC VOLVO 340/343/345</p> 	<p>18-8010190 STD -mm</p>	<p>A = 37,500 B = 64,000</p>	<p>RE49070000 -STD RE49070050 -0,50</p> <p>1,750 (500) Cr S IF 2,000 (508) P 4,000 (700) Cr P S</p>	<p>ø20,0 x 64,0</p>	<p>G80551340S_1</p> <p>A= 79,500 B= 75,000 D= 89,200 F= 0,000 H= 90,000 L= 135,000</p> 		<p>O-Ring Bilgi</p> <p>04x 77,2x1,25</p>
<p>ø76,50</p> <p>4 Cyl. Diesel 1588 cc 2383 cc 37/40/44/51 /55/57/60,5 Kw (50/54/60/69/75/78/82 Ps) D24 ADK CR JK JP CY JR JX MF ATC 1S CP DW 751 <u>1980 - 1992</u> Volvo 240D/244D/245D/740D Golf Polo Bora Audi 80 1.6D/TD Audi 90 1.6TD Audi 100 2.0D/TD Audi 100 2.4TD SKODA</p> 	<p>18-7050760 STD -mm 18-7050763 0,50 mm</p>	<p>A = 41,700 B = 71,700 C = 1,600</p> <p>Ring Carrier Steel Support</p>	<p>RE56110000 -STD RE56110050 -0,50 RE56110100 -1,00</p> <p>1,750 (500) CrB Fe S 2,000 (501) Cr IFU 3,000 (604) Cr</p>	<p>ø24,0 x 64,0</p>			<p>1. Notch 1.40 mm Gasket + 0,67 + 0,80</p> <p>2. Notch 1.50 mm Gasket + 0,81 + 0,90</p> <p>3. Notch 1.60 mm Gasket + 0,91 + 1,02</p>

Engine	Ref. No. - Kit 1	Dimensions	Rings	Pin	Piston Liner	Kit 2	Info
<p>ø79,00</p> <p>4 Cyl. Gasoline 1600 cc</p> <p>1.6 Ecoboost</p> <p>..... -</p> <p>1.6 EcoBoost</p>	<p>18-2510440 STD -mm 18-2510440-20 STD -mm (0.2 mm SHORT)</p> <p>18-2510443 0,50 mm 18-2510443-20 0,50 mm (0.2 mm SHORT)</p>	<p>A = 28,300 B = 54,200 C = 5,000 CD= 53,500</p> <p>Hard Anodising</p>	<p>RE43490000 -STD RE43490050 -0,50 RE43490100 -1,00</p> <p>1,200 (500) NitB S 1,200 (501) P 2,000 (700) Cr P S</p>	<p>ø21,0 x 46,0</p>			
<p>ø81,00</p> <p>4 Cyl. Gasoline 1721 cc 59/60.5/60/90KW (80/82/122 PS) 10:1 F2NA 700/E708 B18E/F/FP/FT <u>1984 - 1989</u></p> <p>Flash R11 GTX/TXE R21 ELECTRONIC R9 GTX/TXE VOLVO 440/460/480</p>	<p>18-8010800 STD -mm 18-8010803 0,50 mm</p>	<p>A = 44,050 B = 70,000 C = 13,870 CD= 59,970</p> <p>Steel Support</p>	<p>RE49110000 -STD RE49110050 -0,50</p> <p>1,750 (500) CrB S IF 2,000 (508) P 3,000 (700) Cr P S</p>	<p>ø21,0 x 65,0</p>			

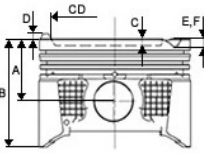
Engine	Ref. No. - Kit 1	Dimensions	Rings	Pin	Piston Liner	Kit 2	Info
<p>ø85,00</p> <p>4 Cyl. Diesel 1997/1998 cc 79/80/81/100Kw 90/107/109Ps 110/136 Ps DW10ATED TD10ATED DW10TD Euro 3 G6DB RHS RHW RHX RHY RHZ D420 4T</p> <p><u>1998 -</u></p> <p>2.0 HDI 206/306/307/406 Boxer Partner Expet C5 Jumpy Xsara Scudo 2.0JTD Cmax Focus II Grand Vitara C30 C70 S40/80 II V50 V70 III TDI</p>	<p>18-7550900 STD -mm 18-7550900-20 STD -mm (0.2 mm SHORT)</p> <p>18-7550903 0,50 mm 18-7550904 0,60 mm</p> 	<p>A = 46,750 B = 80,750 C = 18,300 E = -1,000 CD= 38,000</p> <p>Ring Carrier Oil Cut-Out</p>	<p>RE47440000 -STD RE47440060 -0,60</p> <p>3,500 (505) Cr P 2,000 (501) P IFU 3,000 (604) Cr P</p>	<p>ø28,0 x 70,0</p>			<p>1,25 mm Gasket +0,55 + 0,60</p> <p>1,30 mm Gasket +0,61 +0,65</p> <p>1,35 mm Gasket +0,66 +0,70</p> <p>1,40 mm Gasket +0,71 +0,75</p>
<p>ø85,00</p> <p>4 Cyl. Diesel 1997/1998 cc 79/80/81/100Kw 90/107/109Ps 110/136 Ps DW10ATED TD10ATED DW10TD Euro 3 G6DB RHS RHW RHX RHY RHZ D420 4T</p> <p><u>1998 -</u></p> <p>2.0 HDI 206/306/307/406 Boxer Partner Expet C5 Jumpy Xsara Scudo 2.0JTD Cmax Focus II Grand Vitara C30 C70 S40/80 II V50 V70 III TDI</p>	<p>18-7550900 STD -mm 18-7550900-20 STD -mm (0.2 mm SHORT)</p> <p>18-7550903 0,50 mm 18-7550904 0,60 mm</p> 	<p>A = 46,750 B = 80,750 C = 18,300 E = -1,000 CD= 38,000</p> <p>Ring Carrier Oil Cut-Out</p>	<p>RE47440000 -STD RE47440060 -0,60</p> <p>3,500 (505) Cr P 2,000 (501) P IFU 3,000 (604) Cr P</p>	<p>ø28,0 x 70,0</p>			<p>1,25 mm Gasket +0,55 + 0,60</p> <p>1,30 mm Gasket +0,61 +0,65</p> <p>1,35 mm Gasket +0,66 +0,70</p> <p>1,40 mm Gasket +0,71 +0,75</p>

							
Engine	Ref. No. - Kit 1	Dimensions	Rings	Pin	Piston Liner	Kit 2	Info
<p>ø88,91</p> <p>4 Diesel, 1986 cm 9,2:1 B200 K <u>1984</u></p> <p>360 240 Poza</p>	<p>18-8510180 STD -mm 18-8510183 0,50 mm</p>	<p>A = 39,700 B = 67,700 C = 0,400 CD= 68,000</p> <p>Steel Support</p>	<p>RE57210000 -STD RE57210015 -0,15 RE57210030 -0,30 RE57210050 -0,50</p> <p>1,750 (500) Cr P 1,750 (508) P IF 3,000 (603) P</p>	<p>ø23,0 x 60,0</p>			
<p>ø88,91</p> <p>4 Diesel, 1986 cm 10.0:1 B200 K/E <u>1984</u></p> <p>360 Lomo</p>	<p>18-8510190 STD -mm 18-8510193 0,50 mm</p>	<p>A = 39,700 D = 2,200 CD= 48,700</p> <p>Steel Support</p>	<p>RE57210000 -STD RE57210015 -0,15 RE57210030 -0,30 RE57210050 -0,50</p> <p>1,750 (500) Cr P 1,750 (508) P IF 3,000 (603) P</p>	<p>ø23,0 x 60,0</p>			



							
Engine	Ref. No. - Kit 1	Dimensions	Rings	Pin	Piston Liner	Kit 2	Info
<p>ø130,18</p> <p>6 Cyl. Diesel 12000 cc 225/273 Kw(306/370 Ps) 13,3:1 TAD 120 BHC TAMD 120 B TD 120 D (1977..1980) TD 120 C/120 E (1977..1984) <u>1977 - 1984</u></p> <p>F 12-38 F 12-46 F 12-49 F 12-52 F 12-59</p>	<p>14-8550500 STD -mm <i>14-8550500-40 STD -mm</i> <i>(0.4 mm SHORT)</i></p>	<p>A = 114,200 B = 175,200 C = 27,620 E = -2,500 CD= 83,000</p> <p>Ring Carrier</p>	<p>RE57110000 -STD</p> <p>2,385 (500) Cr 3,160 (508) Cr P 4,747 (604) Cr P</p>	<p>ø55,0 x 68,0</p>			<p>0,05 + 0,45</p>
